

This manual should be considered a permanent part of the motorcycle and should remain with the motorcycle when it is resold.

This publication includes the latest production information available before printing. Honda Motor Co., Ltd. reserves the right to make changes at any time without notice and without incurring any obligation.

No part of this publication may be reproduced without written permission.

© 2004 Honda Motor Co., Ltd.

**2005  
Honda CBR1000RR  
OWNER'S MANUAL**

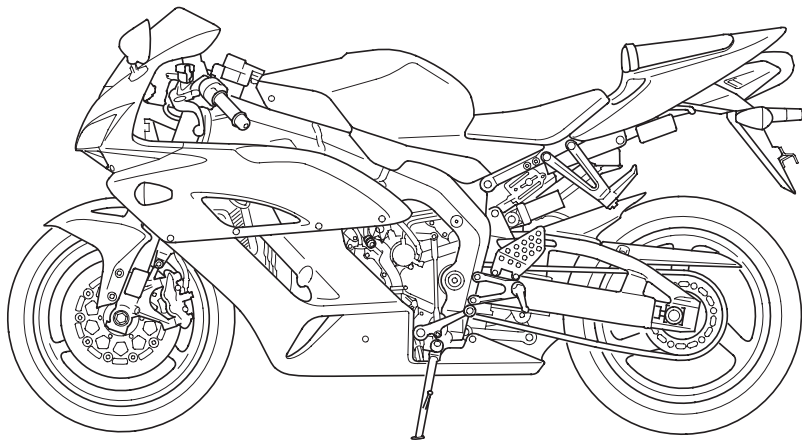

# Introduction

---

Congratulations on choosing your Honda motorcycle.

When you own a Honda, you're part of a worldwide family of satisfied customers — people who appreciate Honda's reputation for building quality into every product.

Before riding, take time to get acquainted with your motorcycle and how it works. To protect your investment, we urge you to take responsibility for keeping your motorcycle well maintained. Scheduled service is a must, of course. But it's just as important to observe the break-in guidelines, and perform all pre-ride and other periodic checks detailed in this manual.

## Introduction

We also recommend that you read this owner's manual before you ride. It's full of facts, instructions, safety information, and helpful tips. To make it easy to use, the manual contains a detailed list of topics at the beginning of each section, and both an in-depth table of contents and an index at the back of the book.

As you read this manual, you will find information that is preceded by a **NOTICE** symbol. This information is intended to help you avoid damage to your Honda, other property, or the environment.

## Introduction

---

Read the Warranties Booklet (page 227 ) thoroughly so you understand the coverages that protect your new Honda and are aware of your rights and responsibilities.

If you have any questions, or if you ever need special service or repairs, remember that your Honda dealer knows your motorcycle best and is dedicated to your complete satisfaction.

Please report any change of address or ownership to your Honda dealer so we will be able to contact you concerning important production information.

You may also want to visit our website at [www.honda.com](http://www.honda.com).

Happy riding!

California Proposition 65 Warning

**WARNING:** This product contains or emits chemicals known to the State of California to cause cancer and birth defects or other reproductive harm.

## A Few Words About Safety

---

Your safety, and the safety of others, is very important. And operating this motorcycle safely is an important responsibility.

To help you make informed decisions about safety, we have provided operating procedures and other information on labels and in this manual. This information alerts you to potential hazards that could hurt you or others.

Of course, it is not practical or possible to warn you about all hazards associated with operating or maintaining a motorcycle. You must use your own good judgment.

You will find important safety information in a variety of forms, including:

- **Safety Labels** — on the motorcycle.
- **Safety Messages** — preceded by a safety alert symbol  and one of three signal words: **DANGER**, **WARNING**, or **CAUTION**.

These signal words mean:

### Safety Messages

## A Few Words About Safety

---

### **DANGER**

You **WILL** be **KILLED** or **SERIOUSLY HURT** if you don't follow instructions.

### **WARNING**

You **CAN** be **KILLED** or **SERIOUSLY HURT** if you don't follow instructions.

### **CAUTION**

You **CAN** be **HURT** if you don't follow instructions.

- **Safety Headings** — such as Important Safety Reminders or Important Safety Precautions.
- **Safety Section** — such as Motorcycle Safety.
- **Instructions** — how to use this motorcycle correctly and safely.

This entire manual is filled with important safety information — please read it carefully.

# Contents

---

These pages give an overview of the contents of your owner's manual. The first page of each section lists the topics covered in that section.

**Motorcycle Safety..... 1**

Important safety information you should know, plus a look at the safety-related labels on your motorcycle.

**Instruments & Controls..... 9**

The location and function of indicators, gauges, and controls on your motorcycle and operating instructions for various controls and features.

**Before Riding..... 45**

The importance of wearing a helmet and other protective gear, how to make sure you and your motorcycle are ready to ride, and important information about loading.

**Basic Operation & Riding..... 55**

How to start and stop the engine, shift gears, and brake. Also, riding precautions and important information about riding with a passenger or cargo.

# Contents

---

## **Servicing Your Honda ..... 71**

Why your motorcycle needs regular maintenance, what you need to know before servicing your Honda, an owner maintenance schedule, and instructions for specific maintenance and adjustment items.

## **Tips ..... 165**

How to store and transport your motorcycle and how to be an environmentally-responsible rider.

## **Taking Care of the Unexpected ..... 171**

What to do if you have a flat tire, your engine won't start, etc.

## **Technical Information ..... 201**

ID numbers, technical specifications, and other technical facts.

## **Consumer Information ..... 223**

Information on warranties, emission controls, how to get Honda service manuals, and...

## **“Reporting Safety Defects” ..... 232**

## **Table of Contents ..... 234**

Sequential listing of topics in this owner's manual.

## **Index ..... 240**

## **Quick Reference**

Handy facts about fuel, engine oil, tire sizes, and air pressures.





# Motorcycle Safety

---

This section presents some of the most important information and recommendations to help you ride your motorcycle safely. Please take a few moments to read these pages. This section also includes information about the location of safety labels on your motorcycle.

Important Safety Information .....	2
Accessories & Modifications .....	5
Safety Labels .....	7

## Important Safety Information

---

Your motorcycle can provide many years of service and pleasure — if you take responsibility for your own safety and understand the challenges you can meet while riding.

There is much that you can do to protect yourself when you ride. You'll find many helpful recommendations throughout this manual. The following are a few that we consider most important.

### **Always Wear a Helmet**

It's a proven fact: helmets significantly reduce the number and severity of head injuries. So always wear an approved motorcycle helmet and make sure your passenger does the same. We also recommend that you wear eye protection, sturdy boots, gloves, and other protective gear (page 46 ).

## Important Safety Information

---

### **Take Time to Learn & Practice**

Even if you have ridden other motorcycles, take time to become familiar with how this motorcycle works and handles. Practice in a safe area until you build your skills and get accustomed to the motorcycle's size and weight.

Because many accidents involve inexperienced or untrained riders, we urge all riders to take a certified course approved by the Motorcycle Safety Foundation (MSF). See page 48 .

### **Ride Defensively**

The most frequent motorcycle collision happens when a car turns left in front of a motorcycle. Another common situation is a car moving suddenly into your lane.

Always pay attention to other vehicles around you, and do not assume that other drivers see you. Be prepared to stop quickly or make an evasive maneuver. For other riding tips, see the booklet, *You and Your Motorcycle: Riding Tips and Practice Guide*, which came with your new motorcycle (USA only).

### **Make Yourself Easy to See**

Some drivers do not see motorcycles because they are not looking for them. To make yourself more visible, wear bright reflective clothing, position yourself so other drivers can see you, signal before turning or changing lanes, and use your horn when it will help others notice you.

## **Important Safety Information**

---

### **Ride within Your Limits**

Pushing limits is another major cause of motorcycle accidents. Never ride beyond your personal abilities or faster than conditions warrant. Remember that alcohol, drugs, fatigue, and inattention can significantly reduce your ability to make good judgments and ride safely.

### **Don't Drink and Ride**

Alcohol and riding don't mix. Even one drink can reduce your ability to respond to changing conditions, and your reaction time gets worse with every additional drink. So don't drink and ride, and don't let your friends drink and ride either.

### **Keep Your Honda in Safe Condition**

It's important to keep your motorcycle properly maintained and in safe riding condition. To help avoid problems, inspect your motorcycle before every ride and perform all recommended maintenance. Never exceed load limits (page 53 ), and do not modify your motorcycle (page 6 ) or install accessories that would make your motorcycle unsafe (page 5 ).

## Accessories & Modifications

Modifying your motorcycle or using non-Honda accessories can make your motorcycle unsafe. Before you consider making any modifications or adding an accessory, be sure to read the following information.

### **WARNING**

Improper accessories or modifications can cause a crash in which you can be seriously hurt or killed.

Follow all instructions in this owner's manual regarding accessories and modifications.

### Accessories

We strongly recommend that you use only genuine Honda accessories that have been specifically designed and tested for your motorcycle. Because Honda cannot test all other accessories, you must be personally responsible for proper selection, installation, and use of non-Honda accessories.

Check with your Honda dealer for assistance and always follow these guidelines:

- Make sure the accessory does not obscure any lights, reduce ground clearance and lean angle, limit suspension travel or steering travel, alter your riding position, or interfere with operating any controls.

## Accessories & Modifications

---

- Do not add any electrical equipment that will exceed the motorcycle's electrical system capacity (page 209). A blown fuse can cause a loss of lights or engine power (page 194).
- Do not pull a trailer or sidecar with your motorcycle. This motorcycle was not designed for these attachments, and their use can seriously impair your motorcycle's handling.

### Modifications

We strongly advise you not to remove any original equipment or modify your motorcycle in any way that would change its design or operation. Such changes could seriously impair your motorcycle's handling, stability, and braking, making it unsafe to ride.

Removing or modifying your lights, exhaust system, emission control system, or other equipment can also make your motorcycle illegal.

## Safety Labels

Safety labels on your motorcycle either warn you of potential hazards that could cause serious injury or they provide important safety information. Read these labels carefully and don't remove them.

If a label comes off or becomes hard to read, contact your Honda dealer for a replacement.

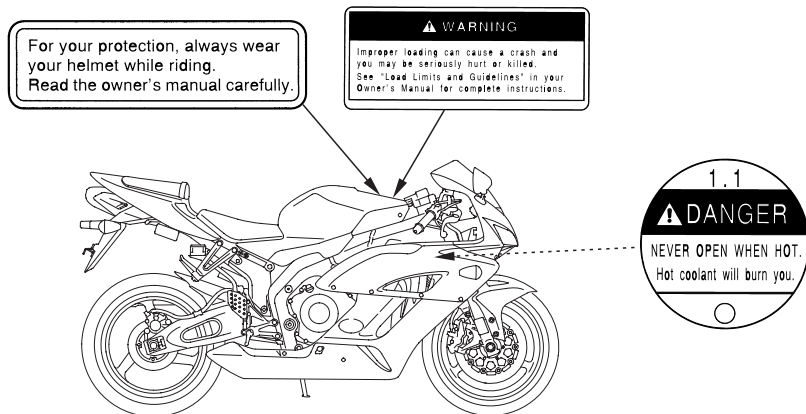



# Safety Labels

< Type II >

For your protection, always wear your helmet while riding.  
Read the owner's manual carefully.

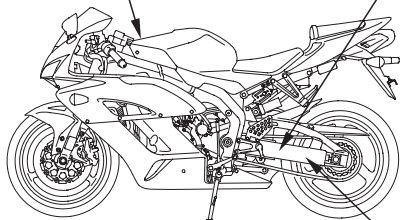

< For USA >

TIRE INFORMATION		
Cold tire pressures:		
[Up to maximum weight capacity]		
Front	250kPa 2.50kgf/cm <sup>2</sup> 36psi	Rear
	290kPa 2.90kgf/cm <sup>2</sup> 42psi	
[Up to 90kg (200lbs) load]		
Front	250kPa 2.50kgf/cm <sup>2</sup> 36psi	Rear
	290kPa 2.90kgf/cm <sup>2</sup> 42psi	
Maximum weight capacity: 166kg (366lbs)		
Tire size: Front 120/70ZR17M/C (58W)		
Rear 180/50ZR17M/C (73W)		
Tire brand Front Rear		
BRIDGESTONE BT014F RADIAL G BT014R RADIAL G		
PIRELLI DIABLO CORSA H DIABLO CORSA H		
Min. recommend tire center tread depth:		
Front 1.5mm (0.06in.)		Rear 2.0mm (0.08in.)
Read owner's manual.		
This motorcycle is equipped with tubeless tires.		

< For Canada >

TIRE INFORMATION		
Cold tire pressures:		
[Up to maximum weight capacity]		
Front	250kPa 2.50kgf/cm <sup>2</sup> 36psi	Rear
	290kPa 2.90kgf/cm <sup>2</sup> 42psi	
[Up to 90kg (200lbs) load]		
Front	250kPa 2.50kgf/cm <sup>2</sup> 36psi	Rear
	290kPa 2.90kgf/cm <sup>2</sup> 42psi	
Maximum weight capacity: 170kg (375lbs)		
Tire size: Front 120/70ZR17M/C (58W)		
Rear 180/50ZR17M/C (73W)		
Tire brand Front Rear		
BRIDGESTONE BT014F RADIAL G BT014R RADIAL G		
PIRELLI DIABLO CORSA H DIABLO CORSA H		
Min. recommend tire center tread depth:		
Front 1.5mm (0.06in.)		Rear 2.0mm (0.08in.)
Read owner's manual.		
This motorcycle is equipped with tubeless tires.		

< Type II >

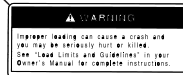

## Instruments & Controls

---

This section shows the location of all gauges, indicators, and controls you would normally use before or while riding your motorcycle.

The items listed on this page are described in this section. Instructions for other components are presented in other sections of this manual where they will be most useful.

Component Locations .....	11
Gauges, Indicators & Displays.....	14
Multi-function Display.....	22
Coolant Temperature Meter .....	23
PGM-FI Indicator and Malfunction Indicator Lamp (MIL)...	25
Low Oil Pressure Indicator and Malfunction Indicator Lamp (MIL)...	26
Coolant Temperature Indicator and Malfunction Indicator Lamp (MIL)...	27
HESD Indicator and Malfunction Indicator Lamp (MIL)...	28
Speedometer .....	29
Odometer .....	29
Tripmeter A & B .....	31
Digital Clock .....	32

(cont'd)

# Instruments & Controls

---

Gauges, Indicators & Displays	
Changing the Speed and Mileage	
Unit .....	34
Changing the Temperature Unit .....	35
Presetting the Shift Indicator and	
Selecting the Display .....	36
Controls & Features	
Ignition Switch .....	39
Start Button.....	40
Engine Stop Switch .....	40
Headlight Dimmer Switch .....	41
Turn Signal Switch.....	41
Horn Button .....	42
RESET Button.....	42
SEL Button .....	43
HESD (Honda Electronic	
Steering Damper) .....	44

# Component Locations

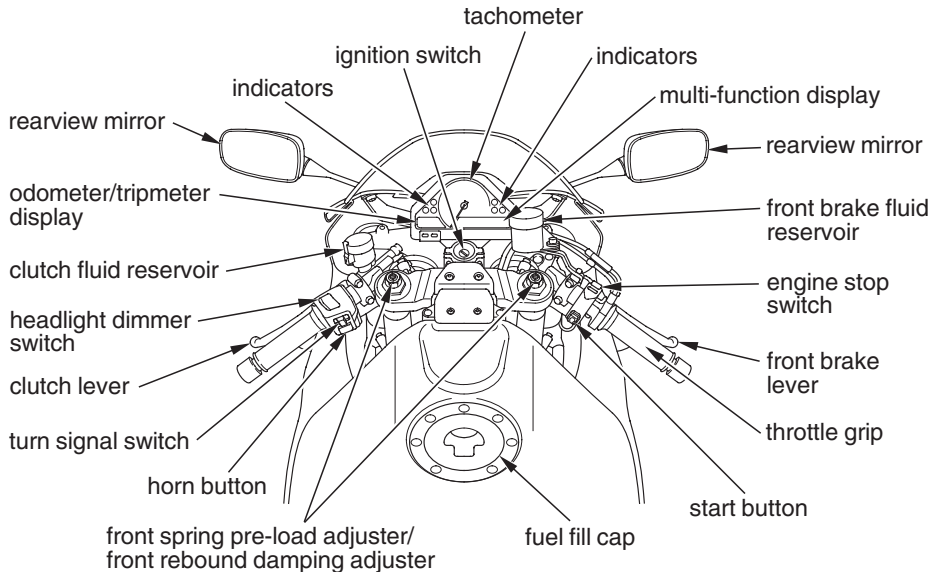

# Component Locations

---

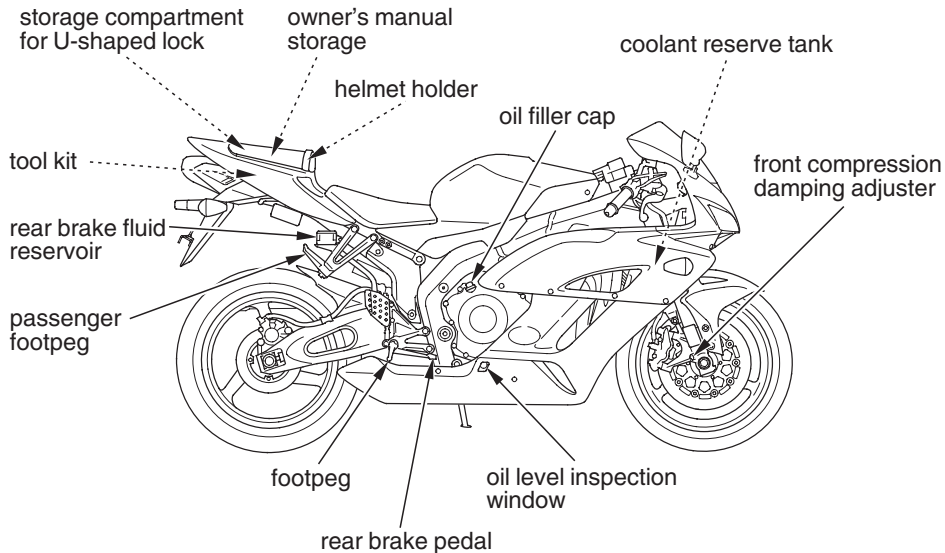

# Component Locations

---

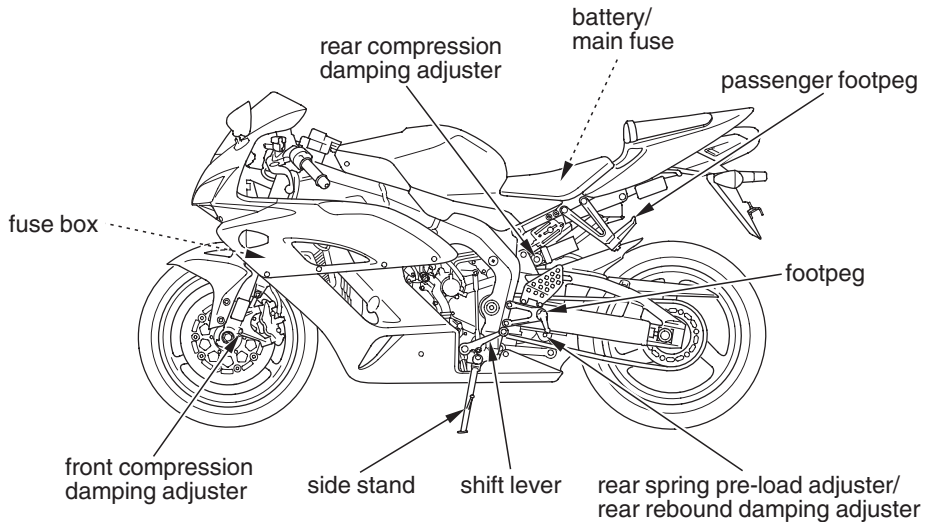

## Gauges, Indicators & Displays

---

The gauges, indicators and displays on your motorcycle keep you informed, alert you to possible problems, and make your riding safer and more enjoyable. Refer to the gauges, indicators and displays frequently. Their functions are described on the following pages.

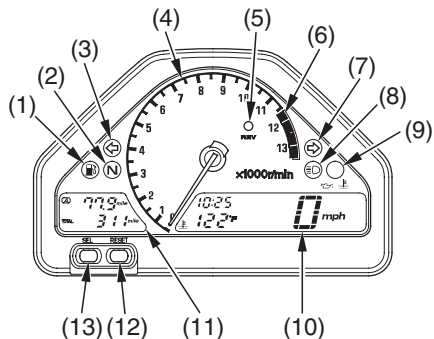

- (1) fuel reserve indicator
- (2) neutral indicator
- (3) left turn signal indicator
- (4) tachometer
- (5) shift indicator
- (6) tachometer red zone
- (7) right turn signal indicator
- (8) high beam indicator
- (9) malfunction indicator lamp (MIL)
- (10) multi-function display
- (11) odometer/tripmeter display
- (12) RESET button
- (13) SEL button

## Gauges, Indicators & Displays

---

### Lamp Check

The malfunction indicator lamp (MIL) comes on when you turn the ignition switch ON so you can check that it is working. The indicator remains on until after the engine is started. The indicator is identified in the table on page 18 with the words: *Lamp Check*.

When applicable, the high beam and neutral indicators come on when you turn the ignition switch ON and remain on until you select the low beam or shift out of neutral.

If one of these indicators does not come on when it should, have your Honda dealer check for problems.

### Meter Check

The tachometer needle will swing to the end of the red zone once when you turn the ignition switch ON.

The meter is identified in the table on page 17 with the words: *Meter Check*.

If the tachometer needle does not swing to the end of the red zone when it should, have your Honda dealer check for problems.



# Gauges, Indicators & Displays

---

## Display Check

When the ignition switch is turned ON, the multi-function display ( 1 ) and odometer/tripmeter display ( 2 ) will temporarily show all the modes and digital segments so you can make sure the liquid crystal display is functioning properly.

The displays are identified in the table on pages 19 – 20 with the words: *Display Check*.

If any part of these displays does not come on when it should, have your Honda dealer check for problems.

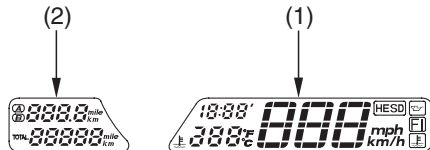

- (1) multi-function display
- (2) odometer/tripmeter display

## Gauges, Indicators & Displays

1	fuel reserve indicator (amber)	When this indicator comes on while riding, fuel reserved in the tank is about: <b>0.92 US gal (3.5 l)</b>
2	neutral indicator (green)	Lights when the transmission is in neutral.
3	left turn signal indicator (amber)	Flashes when the left turn signal operates.
4	tachometer	Shows engine speed in revolutions per minute (rpm). <i>Meter Check.</i>
5	shift indicator (amber)	Flashes when the tachometer needle enters in the red zone or reaches your selected shift point (page 36 ).
6	tachometer red zone	Shows excessive engine rpm range (indicated from the beginning of the tachometer red zone) in which operation may damage the engine. Do not let the tachometer needle enter the red zone.

## Gauges, Indicators & Displays

---

7	right turn signal indicator (amber)	Flashes when the right turn signal operates.
8	high beam indicator (blue)	Lights when the headlight is on high beam.
9	malfunction indicator lamp (MIL) (red)	Lights when PGM-FI (Programmed Fuel Injection) system is abnormal, coolant is over the specified temperature, engine oil pressure is below normal operating range, and/or HESD (Honda Electronic Steering Damper) is abnormal. If the indicator lights, pull safely to the side of the road. (pages 25 – 28 ). <i>Lamp Check.</i> See pages 191 – 193 for instructions and cautions.

## Gauges, Indicators & Displays

10	multi-function display	The display includes the following functions: <i>Display Check.</i>
	PGM-FI indicator/low oil pressure indicator/coolant temperature indicator/HESD indicator	Lights the PGM-FI indicator, low oil pressure indicator, coolant temperature indicator and/or HESD indicator to notify that there is abnormality in the PGM-FI (Programmed Fuel Injection) system, engine oil pressure, coolant temperature and/or HESD (Honda Electronic Steering Damper) when the malfunction indicator lamp (MIL) lights. See pages 25 – 28 .
	speedometer	Shows riding speed in miles or kilometers per hour (page 29 ).
	digital clock	Shows hour and minute (page 32 ).
	coolant temperature meter	Shows coolant temperature (page 23 ). Fahrenheit (°F) or Centigrade (°C).

## Gauges, Indicators & Displays

---

11	odometer/tripmeter display	The display includes the following functions: <i>Display Check.</i>
	odometer	Shows the total miles or kilometers ridden (page 29 ).
	tripmeter A & B	Shows the number of miles or kilometers ridden since you last reset the meter. The tripmeter has two sub modes, ‘A’ and ‘B.’ To zero (0) the tripmeter, push and hold the RESET button (page 31 ).

## Gauges, Indicators & Displays

12	RESET button	<p>Use this button for the following purposes:</p> <ul style="list-style-type: none"><li>• To adjust time (page 32 )</li><li>• To reset tripmeter (page 31 )</li><li>• To change unit of the speedometer, odometer and tripmeter (page 34 )</li><li>• To change the setting of the shift indicator and selection of the display (pages 36 – 38 )</li><li>• To change unit of the temperature meter (USA only) (page 35 )</li><li>• To display the total mileage of the odometer when you drive 100,000 miles (kilometers) or more (page 30 )</li></ul>
13	SEL button	<p>Use this button for the following purposes:</p> <ul style="list-style-type: none"><li>• To adjust time (page 32 )</li><li>• To change display of tripmeter A and B (page 31 )</li><li>• To change unit of the speedometer, odometer and tripmeter (page 34 )</li><li>• To change the setting of the shift indicator and selection of the display (pages 36 – 38 )</li><li>• To change unit of the temperature meter (USA only) (page 35 )</li></ul>

# Gauges, Indicators & Displays

## Multi-function Display

The multi-function display (1) includes the following functions:

- low oil pressure indicator
- coolant temperature indicator
- PGM-FI indicator
- HESD indicator
- speedometer
- digital clock
- coolant temperature meter

The odometer/tripmeter display (2) includes the following functions:

- odometer
- tripmeter

Digital clock will reset if the battery is disconnected.

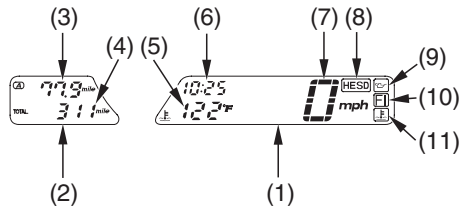

- (1) multi-function display
- (2) odometer/tripmeter display
- (3) tripmeter
- (4) odometer
- (5) coolant temperature meter
- (6) digital clock
- (7) speedometer
- (8) HESD indicator
- (9) low oil pressure indicator
- (10) PGM-FI indicator
- (11) coolant temperature indicator

# Gauges, Indicators & Displays

## Coolant Temperature Meter

The coolant temperature meter (1) shows the coolant temperature digitally.

USA : Fahrenheit ( $^{\circ}\text{F}$ ), or  
Centigrade ( $^{\circ}\text{C}$ ).

Canada : Centigrade ( $^{\circ}\text{C}$ ).

### Temperature Display

Below 94 $^{\circ}\text{F}$ (34 $^{\circ}\text{C}$ )	“--” is displayed
Between 95 $^{\circ}\text{F}$ – 270 $^{\circ}\text{F}$ (35 $^{\circ}\text{C}$ – 132 $^{\circ}\text{C}$ )	Actual coolant temperature is displayed.
Above 270 $^{\circ}\text{F}$ (132 $^{\circ}\text{C}$ )	The display remains “270 $^{\circ}\text{F}$ (132 $^{\circ}\text{C}$ )”

< Fahrenheit ( $^{\circ}\text{F}$ ) >



< Centigrade ( $^{\circ}\text{C}$ ) >



(1) coolant temperature meter



## Gauges, Indicators & Displays

### Overheating Message:

When the coolant temperature reaches 252°F (122°C), the numbers in the temperature display start flashing. At the same time, the coolant temperature indicator (2) and the malfunction indicator lamp (MIL) (3) light.

If this occurs, stop the engine and check the reverse tank coolant level. Read pages 111 – 114 and do not ride the motorcycle until the problem has been corrected.

### NOTICE

*Continuing to ride with an overheated engine can cause serious engine damage.*

< Fahrenheit (°F) >



< Centigrade (°C) >

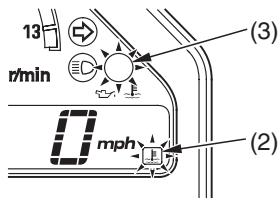

- (2) coolant temperature indicator
- (3) malfunction indicator lamp (MIL)

### PGM-FI Indicator and Malfunction Indicator Lamp (MIL)

The PGM-FI indicator (1) and the malfunction indicator lamp (MIL) (2) light when there is any abnormality in the PGM-FI (Programmed Fuel Injection) system.

The PGM-FI indicator should also go on for a few seconds and then go off when the ignition switch is turned ON and the engine stop switch at RUN.

If the PGM-FI indicator and the malfunction indicator lamp (MIL) light at any other time, reduce speed and take your motorcycle to a Honda dealer as soon as possible.

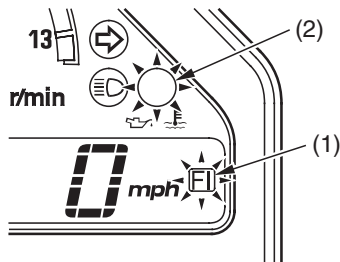

- (1) PGM-FI indicator
- (2) malfunction indicator lamp (MIL)

## Gauges, Indicators & Displays

### Low Oil Pressure Indicator and Malfunction Indicator Lamp (MIL)

The low oil pressure indicator (1) and the malfunction indicator lamp (MIL) (2) light when engine oil pressure is low enough to cause engine damage.

The low oil pressure indicator and the malfunction indicator lamp (MIL) should also light when the ignition switch is turned ON. The malfunction indicator lamp (MIL) and the low oil pressure indicator stay on until after the engine is started.

If the low oil pressure indicator and the malfunction indicator lamp (MIL) light, pull safely to the side of the road. See page 193 for instructions and cautions.

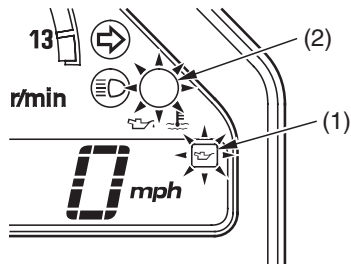

- (1) low oil pressure indicator
- (2) malfunction indicator lamp (MIL)

## Gauges, Indicators & Displays

### Coolant Temperature Indicator and Malfunction Indicator Lamp (MIL)

The coolant temperature indicator (1) and the malfunction indicator lamp (MIL) (2) light when the coolant temperature reaches 252°F (122°C). At the same time, the numbers in the coolant temperature meter display start flashing.

If this occurs, stop the engine and check the reserve tank coolant level. Read pages 111 – 114 and do not ride the motorcycle until the problem has been corrected.

#### NOTICE

*Continuing to ride with an overheated engine can cause serious engine damage.*

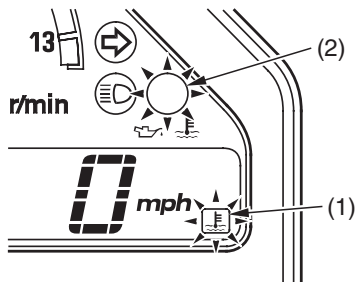

- (1) coolant temperature indicator
- (2) malfunction indicator lamp (MIL)

## Gauges, Indicators & Displays

### HESD Indicator and Malfunction Indicator Lamp (MIL)

The HESD indicator (1) and the malfunction indicator lamp (MIL) (2) light when there is any abnormality in the HESD (Honda Electronic Steering Damper).

The HESD indicator should also go on for a few seconds and then go off when the ignition switch is turned ON and the engine stop switch at RUN.

If the HESD indicator and the malfunction indicator lamp (MIL) light at any other time, reduce speed and take your motorcycle to a Honda dealer as soon as possible.

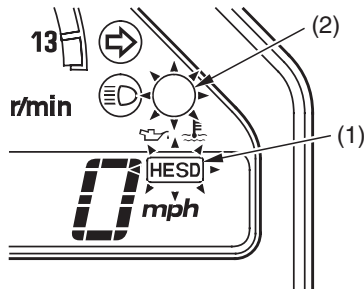

- (1) HESD indicator
- (2) malfunction indicator lamp (MIL)

# Gauges, Indicators & Displays

## Speedometer

The speedometer (1) shows riding speed in miles or kilometers per hour.

## Odometer

The odometer (2) shows the total miles or kilometers ridden.

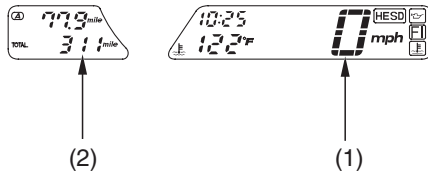

- (1) speedometer
- (2) odometer

## Gauges, Indicators & Displays

---

This meter can display from 0 to 99,999 miles (kilometers). If the display exceeds 99,999 miles (kilometers), it will return to 0 automatically.

If you drive 100,000 miles (kilometers) or more, the total mileage of the odometer can be displayed in the following ways.

Press and hold the RESET button (3), then turn on the ignition switch. Keep the RESET button pressed in until the initial display is completed. The 6th digit and the first 5 digits will alternate in the display for 10 seconds. Then the display returns to normal.

Example: the case of 123,000 miles run.

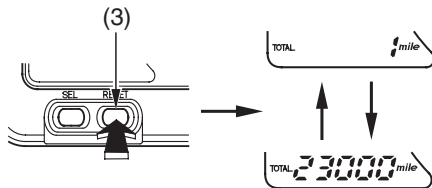

(3) RESET button

## Gauges, Indicators & Displays

### Tripmeter A & B

The tripmeter (1) shows number of miles or kilometers ridden since you last reset the meter.

The tripmeter has two sub modes, A (2) and B (3).

Push the SEL button (4) to switch between the A (2) and B (3) modes.

To reset the tripmeter, push and hold the RESET button (5) with the display in the tripmeter mode.

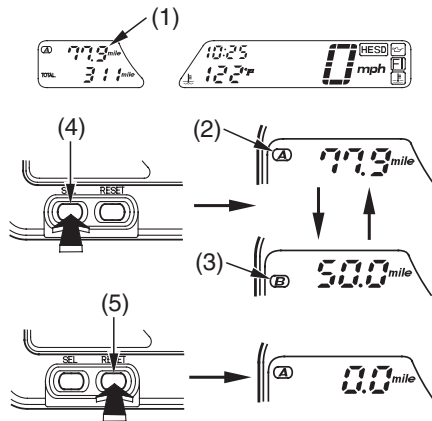

(1) tripmeter  
(2) tripmeter A  
(3) tripmeter B

(4) SEL button  
(5) RESET button



# Gauges, Indicators & Displays

## Digital Clock

Shows hour and minute. To adjust the time, proceed as follows:

1. Turn the ignition switch ON.
2. Press and hold both the SEL button (1) and RESET button (2) for more than 2 seconds. The clock will be set in the adjust mode with the hour display flashing.

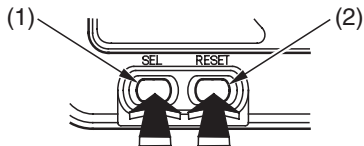

- (1) SEL button  
(2) RESET button



3. To set the hour, press the RESET button until the desired hour appears.
  - Quick setting — press and hold the RESET button until the desired hour appears.
4. Press the SEL button when the display reaches the desired hour appears. The minute display will be flashing.



## Gauges, Indicators & Displays

---

5. To set the minute, press the RESET button until the desired minute appears.
  - Quick setting — press and hold the RESET button until the desired minute appears.
6. To end the adjustment, press the SEL button.

The display will stop flashing automatically and the adjustment will be cancelled if the button is not pressed for about 30 seconds.

As you turn off the ignition switch during the presetting procedures, the preset data just before turning off the ignition switch will be registered.

The clock will be reset 1:00 if the battery is disconnected.

## Gauges, Indicators & Displays

### Changing the Speed and Mileage Unit

This function can be operated after the time adjustment mode (page 32).

The speedometer displays both “mph” and “km/h.”

The odometer/tripmeter displays both “mile” and “km.”

Push the RESET button (1) to select “mph”/“mile” and “km/h”/“km.”

To end the selection, push the SEL button (2).

The display will stop flashing automatically if the button is not pressed for about 30 seconds.

As you turn off the ignition switch during the presetting procedures, the preset data just before turning off the ignition switch will be registered.

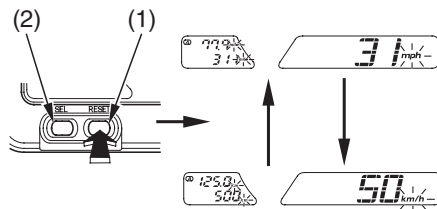

- (1) RESET button
- (2) SEL button

## Gauges, Indicators & Displays

### Changing the Temperature Unit

(USA only)

This function can be operated after the speed and mileage unit change mode (page 34 ).

The coolant temperature meter displays both “°F” (Fahrenheit) and “°C” (Centigrade).

Push the RESET button (1) to select “°F” or “°C”.

To end the selection, push the SEL button (2).

The display will stop flashing automatically if the button is not pressed for about 30 seconds.

As you turn off the ignition switch during the presetting procedures, the preset data just before turning off the ignition switch will be registered.

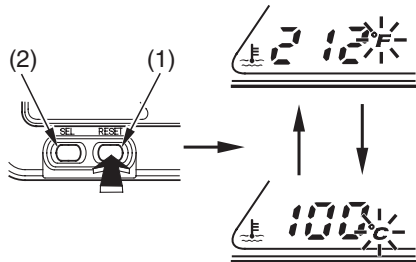

- (1) RESET button
- (2) SEL button

## Gauges, Indicators & Displays

### Presetting the Shift Indicator and Selecting the Display

You may select the rpm activation point (in the 4,000 rpm to 11,650 rpm range) for the shift indicator and select the display used to alert you.

To set the shift indicator:

1. Press and hold the SEL button (1), then turn on the ignition switch. Keep the SEL button pressed in until the initial display is completed. The tachometer needle moves to its preset position.
2. Each time you press the RESET button (2), the tachometer needle (3) will move by an increment of 250 rpm. (In 11,500 rpm ~ 11,650 rpm range, the increment is 150 rpm.)

Push and hold the RESET button for more than 1 second, the tachometer needle will move by an increment of 1,000 rpm.

When the needle exceeds the allowable range, it will automatically return to 4,000 rpm.

After completing the selection, press the SEL button, and proceed to the selecting the display for the indicator.

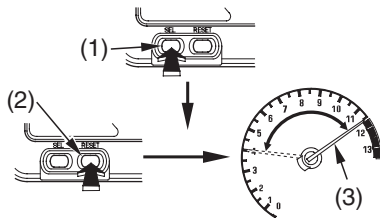

- (1) SEL button      (3) Tachometer needle  
(2) RESET button

## Gauges, Indicators & Displays

To select the indicator display:

You may choose from 9 different indicator displays (page 38 ).

Press the RESET button ( 1 ) repeatedly to view available displays.

Once you reach the display you want, press the SEL button ( 2 ). Then turn off the ignition switch to register your selection.

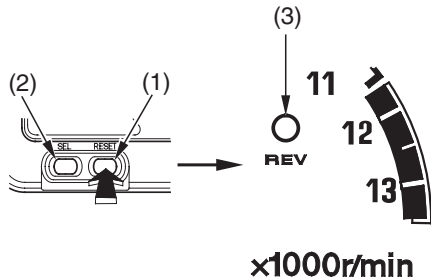

- (1) RESET button
- (2) SEL button
- (3) shift indicator

# Gauges, Indicators & Displays

---

## Available displays

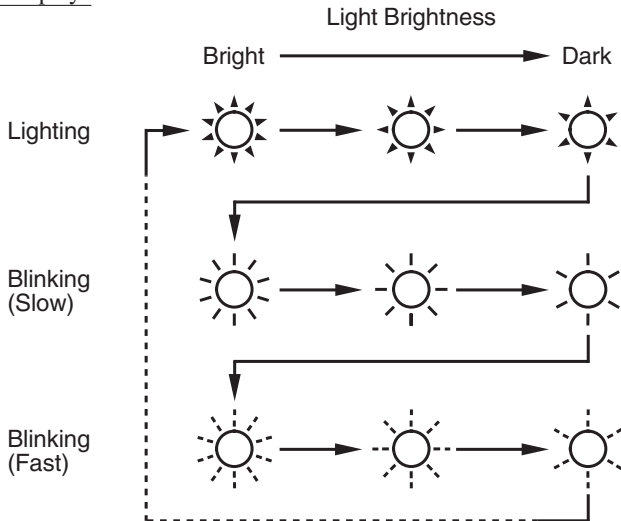

### Ignition Switch

The ignition switch (1) is used for starting and stopping the engine (page 57) and to lock the steering for theft prevention (page 66). Insert the key and turn it to the right for the ON position. Push down on the key and turn it to the left to the LOCK (steering lock) position.

Key Position	Function
ON	Electrical circuits on.
OFF	No electrical circuits function.
LOCK (steering lock)	No electrical circuits function. Locks the steering head.

FRONT

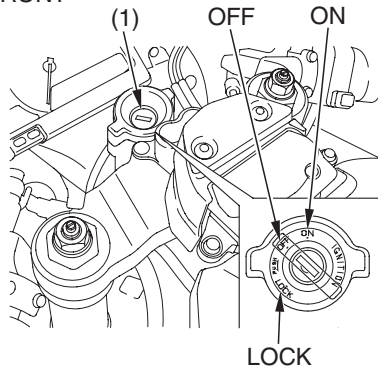

(1) ignition switch

To unlock the steering lock, insert and push down on the key and turn it to the right to the OFF position.



## Controls & Features

### Start Button



The start button (1) is used for starting the engine. Pushing the button in starts the engine. See *Starting Procedure*, page 58.

When the start button is pushed, the starter motor will crank the engine; the headlight will automatically go out, but the taillight will stay on.

The engine will not operate if the engine stop switch is in the OFF position when the start button is pushed.

### Engine Stop Switch



#### RIGHT HANDLEBAR

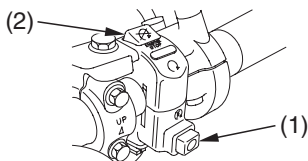

- |                        |  |     |
|------------------------|--|-----|
| (1) start button       |  | OFF |
| (2) engine stop switch |  | RUN |

The engine stop switch (2) is used to stop the engine in an emergency. To operate, push the switch to the OFF position. The switch must be in the RUN position to start the engine, and it should normally remain in the RUN position even when the engine is OFF.

If your motorcycle is stopped with the ignition switch ON and the engine stop switch OFF, the headlight and taillight will remain on, resulting in battery discharge.

### Headlight Dimmer Switch



The headlight dimmer switch (1) is used to change between the high and low beams of the headlight. To operate, turn the switch to HI for high beam, LO for low beam.

### Turn Signal Switch

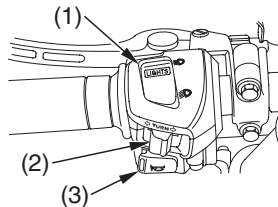

The turn signal switch (2) is used to signal a turn or a lane change. To operate, move the switch all the way in the proper direction and release it. The appropriate turn signal lights will start blinking. To cancel the light, push the switch in.



- (1) headlight dimmer switch  HI
- (2) turn signal switch  LO
- (3) horn button

# Controls & Features

---

## Horn Button

The horn is used to alert other motorists. To operate, push the horn button (3).

## RESET Button

Resets the tripmeter to zero (0) (page 31).

Also used to change the speed and mileage unit for the speedometer/odometer/tripmeter (page 34).

Also used to change the temperature unit for the coolant temperature meter (page 35). (USA only)

Also used to change the shift indicator and its display (pages 36 – 38).

Also used to display the total mileage of the odometer when you drive 100,000 miles (kilometers) or more (page 30).

Also used to set the digital clock (page 32).

### **SEL Button**

The SEL button is used to select tripmeter A or B (page 31 ).

Also used to change the speed and mileage unit for the speedometer/odometer/tripmeter (page 34 ).

Also used to change the temperature unit for the coolant temperature meter (page 35 ). (USA only)

Also used to change the shift indicator and its display (pages 36 – 38 ).

Also used to set the digital clock (page 32 ).

## Controls & Features

---

### HESD (Honda Electronic Steering Damper)

This motorcycle is equipped with the electronically-controlled steering damper.

The HESD automatically controls the steering damper characteristics in accordance with the vehicle speed and the acceleration.

If the HESD indicator and the malfunction indicator lamp (MIL) light at any other time, reduce speed and take your motorcycle to a Honda dealer as soon as possible.

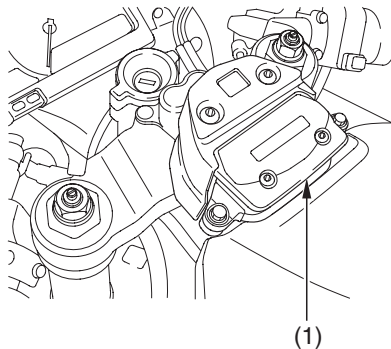

(1) HESD

## Before Riding

---

Before each ride, you need to make sure you and your Honda are both ready to ride. To help get you prepared, this section discusses how to evaluate your riding readiness, what items you should check on your motorcycle, and adjustments to make for your comfort, convenience, or safety. This section also includes important information about loading.

For information about adjusting the suspension on your Honda, see page 122 .

Are You Ready to Ride ? .....	46
Protective Apparel.....	46
Rider Training .....	48
Is Your Motorcycle Ready to Ride ? ....	49
Pre-ride Inspection .....	49
Load Limits & Guidelines.....	52
Loading.....	52
Load Limits .....	53
Loading Guidelines .....	53

## Are You Ready to Ride?

---

Before you ride your motorcycle for the first time, we urge you to:

- Read this owner's manual.
- Make sure you understand all the safety messages.
- Know how to operate all the controls.

Before each ride, be sure:

- You feel well and are in good physical and mental condition.
- You are wearing an approved motorcycle helmet (with chin strap tightened securely), eye protection, and other protective clothing.
- You don't have any alcohol or drugs in your system.

Make sure your passenger is ready to ride, too, and is wearing proper gear including a helmet.

If you must carry an extra helmet while riding, use a commercially-available elastic cord, strap, or net to secure the helmet to the seat.

### Protective Apparel

For your safety, we strongly recommend that you always wear an approved motorcycle helmet, eye protection, boots, gloves, long pants, and a long-sleeved shirt or jacket whenever you ride.

Although complete protection is not possible, wearing proper gear can reduce the chance of injury when you ride.

Following are suggestions to help you choose the proper gear.

## Are You Ready to Ride?

### Helmets and Eye Protection

Your helmet is your most important piece of riding gear because it offers the best protection against head injuries. A helmet should fit your head comfortably and securely. A bright-colored helmet and reflective strips can make you more noticeable in traffic.

An open-face helmet offers some protection, but a full-face helmet offers more. Regardless of the style, look for a DOT (Department of Transportation) sticker in any helmet you buy (USA only). Always wear a face shield or goggles to protect your eyes and help your vision.

### **⚠ WARNING**

Not wearing a helmet increases the chance of serious injury or death in a crash.

Be sure you and your passenger always wear a helmet, eye protection, and other protective apparel when you ride.

### Additional Riding Gear

In addition to a helmet and eye protection, we also recommend:

- Sturdy boots with non-slip soles to help protect your feet and ankles.
- Leather gloves to help protect your hands.

(cont'd)



## Are You Ready to Ride?

---

- A motorcycle riding suit or jacket for comfort as well as protection. Bright-colored and reflective clothing can help make you more noticeable in traffic. Avoid loose clothes that could get caught on any part of your motorcycle.

### Rider Training

Developing your riding skills is an on-going process. Even if you have ridden other motorcycles, take time to become familiar with how this motorcycle works and handles. Practice riding the motorcycle in a safe area to build your skills. Do not ride in traffic until you get accustomed to the motorcycle's controls, and feel comfortable with its size and weight.

We urge all riders to take a certified course approved by the Motorcycle Safety Foundation (MSF). New riders should start with the basic course, and even experienced riders will find the advanced course beneficial. For information about the MSF training course nearest you, call the national toll-free number: (800) 446-9227.

Other riding tips can be found in the *Riding Tips* booklet that came with your motorcycle (USA only).

# Is Your Motorcycle Ready to Ride?

Before each ride, it's important to inspect your motorcycle and make sure any problem you find is corrected. A pre-ride inspection is a must, not only for safety, but because having a breakdown, or even a flat tire, can be a major inconvenience.

## **WARNING**

Improperly maintaining this motorcycle or failing to correct a problem before riding can cause a crash in which you can be seriously hurt or killed.

Always perform a pre-ride inspection before every ride and correct any problems.

## Pre-ride Inspection

Check the following items before you get on the motorcycle:

- |                           |                                                                                                                                                                                 |
|---------------------------|---------------------------------------------------------------------------------------------------------------------------------------------------------------------------------|
| <i>Tires &amp; Wheels</i> | Look at the tires. If a tire appears low, use an air pressure gauge to check its pressure. Also look for signs of excessive wear (page 139 ) or damage to the tires and wheels. |
| <i>Chain</i>              | Check the condition of the chain. Adjust slack and lubricate as needed (page 146 ).                                                                                             |

(cont'd)

## Is Your Motorcycle Ready to Ride?

---

*Leaks,  
Loose  
Parts*

Walk around your motorcycle and look for anything that appears unusual, such as a leak or loose cable.

*Lights*

Make sure the headlight, brake light, taillight, and turn signals are working properly.

If you are carrying a passenger or cargo, also check the following:

*Load Limits* Make sure you do not exceed the load limits (page 53).

*Cargo* Check that all cargo is secure.

*Adjustments* Adjust the suspension (pages 123, 127) according to your load.

## Is Your Motorcycle Ready to Ride?

---

Check these items after you get on the motorcycle:

- Throttle*      Rotate the throttle to check it moves smoothly without binding.
- Brakes*        Pull the brake lever and press on the brake pedal to check that they operate normally.
- Indicators*    Turn the ignition on and check for normal operation of the indicators (page 14).

If you haven't ridden the motorcycle in over a week, you should also check other items, such as the oil level and other fluids. See *Periodic Maintenance* (page 79 ). Periodic maintenance should also be done at least once a month, no matter how often you ride.

Remember, be sure to take care of any problem you find, or have your Honda dealer correct it before you ride.

## Load Limits & Guidelines

---

Your motorcycle has been designed to carry you and one passenger. When you carry a passenger, you may feel some difference during acceleration and braking. But so long as you keep your motorcycle well-maintained, with good tires and brakes, you can safely carry loads within the given limits and guidelines.

However, exceeding the weight limit or carrying an unbalanced load can seriously impair your motorcycle's handling, braking, and stability. Non-Honda accessories, improper modifications, and poor maintenance can also reduce your safety margin.

### Loading

How much weight you put on your motorcycle, and how you load it, are important to your safety. Anytime you ride with a passenger or cargo, you should be aware of the following information.

#### **WARNING**

Overloading or improper loading can cause a crash and you can be seriously hurt or killed.

Follow all load limits and other loading guidelines in this manual.

## Load Limits & Guidelines

### Load Limits

Following are the load limits for your motorcycle:

**maximum weight capacity:**

366 lbs (166 kg)

375 lbs (170 kg) (Canada only)

includes the weight of the rider, passenger, all cargo, and all accessories.

**maximum cargo weight:**

31 lbs (14 kg)

The weight of added accessories will reduce the maximum cargo weight you can carry.

### Loading Guidelines

Your motorcycle is primarily intended for transporting you and a passenger. You may wish to secure a jacket or other small items to the seat when you are not riding with a passenger.

If you wish to carry more cargo, check with your Honda dealer for advice, and be sure to read the information regarding accessories on page 5.

Improperly loading your motorcycle can affect its stability and handling. Even if your motorcycle is properly loaded, you should ride at reduced speeds and never exceed 80 mph (130 km/h) when carrying cargo.

## Load Limits & Guidelines

---

Follow these guidelines whenever you carry a passenger or cargo:

- Check that both tires are properly inflated (page 137).
- If you change your normal load, you may need to adjust the front suspension (page 123) and the rear suspension (page 127).
- To prevent loose items from creating a hazard, make sure that all cargo is tied down securely before you ride.
- Place cargo weight as low and close to the center of your motorcycle as possible.
- Balance cargo weight evenly on both sides.

## Basic Operation & Riding

---

This section gives basic riding instructions, including how to start and stop your engine, and how to use the throttle, clutch, and brakes. It also provides important information on riding with a passenger or cargo.

To protect your new engine and enjoy optimum performance and service life, refer to Break-in Guidelines (page 212 ).

### *California only:*

To protect the catalytic converter in your motorcycle's exhaust system, avoid extended idling and the use of leaded gasoline.

Safe Riding Precautions .....	56
Starting & Stopping the Engine .....	57
Preparation.....	57
Starting Procedure .....	58
Flooded Engine.....	59
Bank Angle Sensor Ignition Cut-off System.....	59
How to Stop the Engine .....	60
Shifting Gears.....	61
Braking .....	63
Parking .....	65
Riding with a Passenger or Cargo.....	70



## Safe Riding Precautions

---

Before riding your motorcycle for the first time, please review the *Motorcycle Safety* section beginning on page 1, and the *Before Riding* section beginning on page 45 .

Even if you have ridden other motorcycles, take time to become familiar with how this motorcycle works and handles. Practice in a safe area until you build your skills and get accustomed to the motorcycle's size and weight.

### *California only:*

Make sure flammable materials such as dry grass or leaves do not come in contact with the exhaust system when riding, idling, or parking your motorcycle.

## Starting & Stopping the Engine

---

Always follow the proper starting procedure described below.

For your safety, avoid starting or operating the engine in an enclosed area such as a garage. Your motorcycle's exhaust contains poisonous carbon monoxide gas which can collect rapidly in an enclosed area and cause illness or death.

Your motorcycle can be started with the transmission in gear by pulling in the clutch lever before operating the starter.

Your motorcycle is equipped with a side stand ignition cut-off system. If the side stand is down—the engine cannot be started unless the transmission is in neutral. If the side stand is up—the engine can be started in neutral, or in gear with the

clutch lever pulled in. After starting with the side stand down, the engine will stop if the transmission is put in gear before raising the side stand.

### Preparation

Before starting, insert the key, turn the ignition switch ON, and confirm the following:

- The transmission is in NEUTRAL (neutral indicator light ON).
- The engine stop switch is set to RUN.
- The malfunction indicator lamp (MIL) is ON.
- The low oil pressure indicator is ON.
- The PGM-FI indicator is OFF.
- The coolant temperature indicator is OFF.
- The HESD indicator is OFF.

## Starting & Stopping the Engine

---

The malfunction indicator lamp (MIL) and low oil pressure indicator should go off a few seconds after the engine starts. If the malfunction indicator lamp (MIL) and the low oil pressure indicator light, stop the engine immediately and check the engine oil level.

### Starting Procedure

This motorcycle has a fuel-injected engine with an automatic fast idle. Follow the procedure indicated below.

#### Any Air Temperature

- Press the start button with the throttle completely closed.

The engine will not start if the throttle is fully open (because the electronic control module cuts off the fuel supply).

Even if the engine coolant stays below the specified temperature, the cooling fan sometimes starts up running when you rev up the engine, but this is normal.

# Starting & Stopping the Engine

---

## Flooded Engine

If the engine fails to start after repeated attempts, it may be flooded with excess fuel. To clear a flooded engine:

1. Leave the engine stop switch set to RUN.
2. Open the throttle fully.
3. Press the start button for 5 seconds.
4. Follow the normal starting procedure.
5. If the engine starts, then open the throttle slightly if idling is unstable. If the engine does not start, wait 10 seconds, then follow steps 1 – 4 again.

If the engine still won't start, refer to *If Your Engine Quits or Won't Start*, page 173.

## Bank Angle Sensor Ignition Cut-off System

Your motorcycle's banking (lean angle) sensor system is designed to automatically stop the engine and fuel pump if the motorcycle is overturned.

Before restarting the engine, you must turn the ignition switch to the OFF position and then back to ON. The engine will not restart until you perform this procedure.

# Starting & Stopping the Engine

---

## How to Stop the Engine

### Normal Engine Stop

To stop the engine, shift into neutral and turn the ignition switch OFF.

The engine stop switch should normally remain in the RUN position even when the engine is OFF.

If your motorcycle is stopped with the engine stop switch OFF and the ignition switch ON, the headlight and taillight will remain on, resulting in battery discharge.

### Emergency Engine Stop

To stop the engine in an emergency, use the engine stop switch. To operate, press the switch to the OFF position.

## Shifting Gears

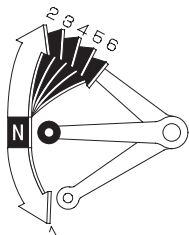

shifting pattern

Your motorcycle has six forward gears in a one-down, five-up shift pattern which is coordinated with a cable-operated clutch system.

Learning when to shift gears comes with experience. Keep the following tips in mind:

- As a general rule, shift while moving in a straight line.

- Close the throttle and pull the clutch lever in completely before shifting. Improper shifting may damage the engine, transmission, and drive train.
- Learn to recognize the engagement point as you release the clutch lever. It is at this point the transmission of power to the rear wheel resumes.
- Upshift to a higher gear or reduce throttle before engine rpm (speed) gets too high. Learn the relationship between engine sound and the normal shifting points.
- Downshift to a lower gear before you feel the engine laboring (lugging) at low rpm.

(cont'd)

## Shifting Gears

---

- Avoid downshifting to help slow your motorcycle when engine rpm is near its allowable maximum (near the tachometer red zone). In this situation, the rev limiter in the engine ignition control module may not prevent excessive engine speed which could damage the engine.
- To prevent transmission damage, do not coast or tow the motorcycle for long distances with the engine off.

### Recommended Shift Points

Ride in the highest gear that lets the engine run and accelerate smoothly. This will give you good fuel economy and effective emissions control. When changing gears under normal conditions, use these recommended shift points:

### *Shifting Up:*

From 1st to 2nd:	12 mph (20 km/h)
From 2nd to 3rd:	19 mph (30 km/h)
From 3rd to 4th:	25 mph (40 km/h)
From 4th to 5th:	31 mph (50 km/h)
From 5th to 6th:	37 mph (60 km/h)

### *Shifting Down:*

From 6th to 5th:	28 mph (45 km/h)
From 5th to 4th:	22 mph (35 km/h)
From 4th to 3rd:	16 mph (25 km/h)

Pull the clutch lever in when speed drops below 9 mph (15 km/h), when engine roughness is evident, or when engine stalling is imminent; and shift down to 1st gear for acceleration.

Your motorcycle is equipped with disc braking systems which are hydraulically activated. Depressing the brake pedal applies the rear disc brake. Operating the brake lever applies the two front disc brakes.

As a general rule, the front braking system provides about 70 percent of total stopping power.

For full braking effectiveness, use both the pedal and lever simultaneously. Using both braking systems will stop your motorcycle faster with greater stability.

To slow or stop, apply the brake lever and brake pedal smoothly, while downshifting to match your speed.

Gradually increase braking as you feel the brakes slowing your speed. The increase in engine compression from downshifting will help slow your motorcycle.

To prevent stalling the engine, pull the clutch lever in before coming to a complete stop. For support, put your left foot down first, then your right foot when you are through using the brake pedal.

Applying the brakes too hard may cause the wheels to lock and slide, reducing control of your motorcycle. If this happens, release the brake controls, steer straight ahead until you regain control, then reapply the brakes more gently.



# Braking

---

When possible, reduce your speed or complete braking before entering a turn. Avoid braking or closing the throttle quickly while turning. Either action may cause one or both wheels to slip and reduce your control of your motorcycle.

Your ability to brake in a turn and to brake hard in an emergency situation are important riding skills. We suggest attending a Motorcycle Safety Foundation experienced rider training course (page 48 ) to retain these skills.

When riding in wet or rainy conditions, or on loose surfaces, the ability to maneuver and stop will be reduced. All of your actions should be smooth under these conditions. Rapid acceleration, braking or turning may cause loss of control. For

your safety, exercise extreme caution when braking, accelerating or turning.

When descending a long, steep grade, use engine compression braking by downshifting, with intermittent use of both brakes. Continuous brake application can overheat the brakes and reduce their effectiveness.

Riding with your foot resting on the brake pedal or your hand on the brake lever may actuate the brakelight, giving a false indication to other drivers. It may also overheat the brakes, reducing effectiveness.

1. Look for a level parking area. If you can't park on a paved surface, make sure the ground surface is firm, especially under the side stand. If you must park on a hill, leave the transmission in gear and position the rear tire against the curb at a 45 degree angle.

*California only:*

Make sure flammable materials such as dry grass or leaves do not come in contact with the exhaust system when parking your motorcycle. Refer to *Catalytic Converter (California Only)*, page 219.

2. Use the side stand to support the motorcycle while parked.
  - To lower the side stand, use your foot to guide it down. Remember that lowering the side stand with the transmission in gear will stop the engine, even if the clutch lever is pulled in. That is a function of the side stand ignition cut-off system.
  - Check that the side stand is down all the way so that the side stand ignition cut-off system (page 57 ) is activated.
  - If you have to park on a soft surface, insert something solid under the side stand for support.

(cont'd)

# Parking

FRONT

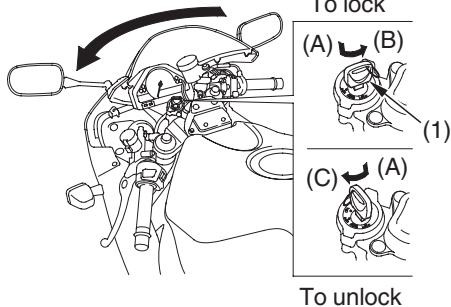

(1) ignition key

(A) push in  
(B) turn to LOCK  
(C) turn to OFF

3. Use the steering lock, which locks the handlebar in place. Turn the handlebar all the way to the left or right. Push in on the ignition key (1) and turn it to LOCK. Remove the key.  
(To unlock the steering lock, insert and push down on the key and turn it to the right to the OFF position.)

### LEFT REAR

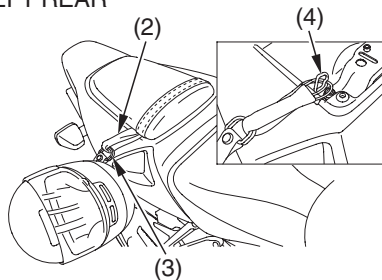

(2) helmet holder wire    (4) helmet holder  
(3) D-ring

4. Use the helmet holder wire stored in the tool kit to secure your helmet with your motorcycle:
  - Remove the rear seat (page 93 ).
  - Route either end of the helmet holder wire (2) through the helmet's D-ring (3).

- Hook the loops of the wire onto the helmet holder (4) and install the rear seat to lock.

Remove the helmet holder wire and store it in the tool kit when it is not used.

### **⚠ WARNING**

Riding with a helmet attached to the holder can interfere with the rear wheel or suspension and could cause a crash in which you can be seriously hurt or killed.

Use the helmet holder only while parked. Do not ride with a helmet secured by the holder.

# Parking

---

## Theft-Prevention Tips

- Park your motorcycle in a locked garage whenever possible. If a garage isn't available, park in a concealed area or in a well-lit area with enough pedestrian traffic to discourage a thief.
  - Always take the ignition key with you.
  - Always use the steering lock (page 66 ), even if you're parking for just a minute or two. A thief can easily push an unlocked motorcycle to a waiting truck.
  - In addition to the steering lock, use a good quality anti-theft device made specifically to lock a motorcycle to a secure object.
- If you decide to use an anti-theft device, select one of good quality and be sure to follow the manufacturer's instructions.
  - The rear fender has a storage compartment to store a U-shaped lock under the rear seat. Some U-shaped locks may not be stored in the compartment due to their size or design.

### UNDER REAR SEAT

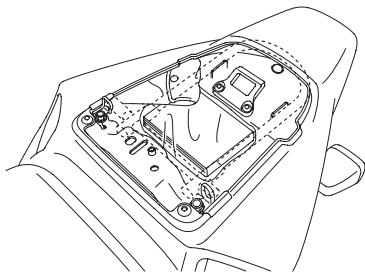

- Keep your owner's manual, current registration, and insurance information with your motorcycle. This will make it easier for the authorities to find you if your motorcycle is stolen and recovered.

## Riding with a Passenger or Cargo

---

Your motorcycle is a high-performance sport model designed to carry you and one passenger. Whenever you add a passenger or cargo, you must be careful not to exceed the total load limits for this vehicle (*Load Limits*, page 53 ). Make sure your cargo is properly secured (*Loading Guidelines*, page 53 ).

Also consider adjusting the suspension (page 122 ) for the extra load.

Be aware that carrying a passenger or heavy cargo can affect acceleration, braking, and handling.

Before riding with a passenger, make sure your passenger is wearing the proper protective apparel (page 46 ). Also check that your passenger is not wearing any loose apparel that might get caught in the drive chain.

Tell your passenger to hold the seat strap or your waist, lean with you in the turns, and keep their feet on the passenger footpegs at all times, even when the motorcycle is stopped at a traffic light.

## Servicing Your Honda

---

To help keep your motorcycle in good shape, this section includes a Maintenance Schedule for required service, a list of periodic checks you should perform at least once a month, and step-by-step instructions for specific maintenance tasks. You'll also find important safety precautions, information on fuels and oils, and tips for keeping your Honda looking great.

For information about the exhaust emission and noise emission requirements of the U.S. Environmental Protection Agency (EPA) and the California Air Resources Board (CARB), see page 213.

For information about replacing fuses, see page 194.

USA only

**Maintenance, replacement or repair of the emission control devices and systems may be performed by any motorcycle repair establishment or individual using parts that are “certified” to EPA standards.**

### *Before You Service Your Honda*

The Importance of Maintenance .....	74
Maintenance Safety .....	75
Important Safety Precautions .....	76
Periodic Maintenance .....	78
Maintenance Schedule .....	80
Maintenance Record.....	85

(cont'd)



# Servicing Your Honda

---

## *Service Preparations*

Component Locations .....	87
Tool Kit.....	90
Owner's Manual Storage.....	91
Seat Removal.....	92
Middle Cowl Removal .....	94
Inner Lower Cowl Removal.....	95
Under Cowl Removal.....	96

## *Service Procedures*

### Fluids & Filters

Fuel .....	97
Engine Oil & Filter.....	101
Coolant.....	111

### Engine

Throttle .....	115
Clutch System.....	117
Engine Idle Speed.....	120

### Chassis

Suspension .....	122
Brakes .....	131
Tires .....	137
Side Stand .....	144
Drive Chain.....	145

### Electrical

Battery.....	152
--------------	-----

Appearance Care .....	157
-----------------------	-----

## Servicing Your Honda

---

The following table summarizes the three types of inspections and servicing recommendations for your motorcycle. Both the pre-ride inspection and the scheduled maintenance at the recommended intervals are necessary to assure safe and dependable performance. The periodic checks provide additional confidence in your motorcycle's performance.

Type of Inspection/Service	Refer to page:	When Performed	Who Performs
Pre-ride Inspection	49	before every ride	you
Periodic Maintenance	78	monthly*	you
Maintenance Schedule	80	interval on schedule	your Honda dealer**

\* more often if you ride frequently or long distances; or anytime you clean your motorcycle

\*\* unless you have the proper tools and service data and are mechanically qualified

## The Importance of Maintenance

---

Keeping your motorcycle well-maintained is absolutely essential to your safety. It's also a good way to protect your investment, get maximum performance, avoid breakdowns, and have more fun. A properly maintained motorcycle will also help to reduce air pollution.

Remember, proper maintenance is the owner's responsibility. Be sure to inspect your motorcycle before each ride, perform the periodic checks, and follow the Maintenance Schedule in this section.

### **WARNING**

Improperly maintaining this motorcycle or failing to correct a problem before you ride can cause a crash in which you can be seriously hurt or killed.

Always follow the inspection and maintenance recommendations and schedules in this owner's manual.

If your motorcycle overturns or is involved in a crash, be sure your Honda dealer inspects all major parts, even if you are able to make some repairs.

## Maintenance Safety

---

This section includes instructions on how to perform some important maintenance tasks. If you have basic mechanical skills, you can perform many of these tasks with the tools provided with your motorcycle.

Other tasks that are more difficult and require special tools are best performed by professionals. Wheel removal should normally be handled only by a Honda technician or other qualified mechanic. Instructions are included in this manual only to assist in emergency service.

Some of the most important safety precautions follow. However, we cannot warn you of every conceivable hazard that can arise in performing maintenance. Only you can decide whether or not you should perform a given task.

### **WARNING**

Failure to properly follow maintenance instructions and precautions can cause you to be seriously hurt or killed.

Always follow the procedures and precautions in this owner's manual.

# Maintenance Safety

---

## Important Safety Precautions

- Make sure the engine is off before you begin any maintenance or repairs. This will help eliminate several potential hazards:

**Carbon monoxide poisoning from engine exhaust.** Be sure there is adequate ventilation whenever you operate the engine.

**Burns from hot motorcycle parts.** Let the engine and exhaust system cool before touching.

**Injury from moving parts.** Do not run the engine unless instructed to do so.

- Read the instructions before you begin, and make sure you have the tools and skills required.
- To help prevent the motorcycle from falling over, park it on a firm, level surface, using the side stand or a maintenance stand to provide support.
- To reduce the possibility of a fire or explosion, be careful when working around gasoline. Use only non-flammable solvent, not gasoline, to clean parts. Keep cigarettes, sparks, and flames away from all fuel-related parts.

Remember that your Honda dealer knows your motorcycle best and is fully equipped to maintain and repair it. To ensure the best quality and reliability, use only new genuine Honda parts or their equivalents for repair and replacement. If you have the tools and skills required for additional maintenance jobs, you can purchase an official Honda Service Manual (page 224 ).

## Periodic Maintenance

---

In addition to the regularly scheduled maintenance (page 80) and daily pre-ride inspection (page 49), consider performing the periodic checks on the following page at least once a month, even if you haven't ridden your motorcycle, or as often as once a week if you ride frequently or for long distances. It's a good idea to perform this maintenance any time you clean your motorcycle.

Check the odometer reading and perform any scheduled maintenance checks that are needed (page 80). Remember, more frequent checks may be needed for riding in severe conditions.

## Periodic Maintenance

<i>Tires &amp; Wheels</i>	Check the air pressure with a gauge and add air if needed (page 137 ). Examine the tread for wear (page 139 ). Look closely for nails, embedded objects, cuts, and other types of damage (page 139 ). Roll your motorcycle so you can inspect the entire surface. Check the condition of the wheels.
Fluids	Check the levels of the engine oil (page 105 ), coolant (page 112 ), clutch fluid (page 118 ) and brake fluid (page 133 ). Add the correct fluid as necessary, and investigate the cause of any low fluid level.
Lights	Make sure the headlight, brake light, taillight, and turn signals are working properly.
Freeplay	Check the freeplay of the clutch lever (page 117 ) and throttle grip (page 115 ).
Drive Chain	Check condition, adjust slack, and lubricate as needed (page 145 ).
Fuses	Make sure you have a full supply of spare fuses.
Nuts & Bolts	Check the major fasteners and tighten as needed.



## Maintenance Schedule

---

The required Maintenance Schedule that follows specifies how often you should have your motorcycle serviced, and what things need attention. It is essential to have your motorcycle serviced as scheduled to maintain safe, dependable performance and proper emission control.

The service intervals in this Maintenance Schedule are based on average riding conditions. Some items will need more frequent service if you ride in unusually wet or dusty areas or at full throttle. Consult your Honda dealer for recommendations applicable to your individual needs and use.

Some items in the Maintenance Schedule can be performed with basic mechanical skills and hand tools. Procedures for these items are provided in this manual. Other items involve more extensive procedures and may require special training, tools, and equipment. We recommend that you have your Honda dealer perform these tasks unless you have advanced mechanical skills and the required tools and equipment. Procedures for such items in this schedule are provided in an official Honda Service Manual available for purchase (page 224 ).

## Maintenance Schedule

---

If you do not feel capable of performing a given task or need assistance, remember that your Honda dealer knows your motorcycle best and is fully equipped to maintain and repair it. If you decide to do your own maintenance, use only genuine Honda parts or their equivalents for repair or replacement to ensure the best quality and reliability.

Perform the pre-ride inspection (page 49) and owner maintenance (page 82) at each scheduled maintenance period.

Each item on the maintenance schedule requires some mechanical knowledge. Certain items (particularly those marked \* and \*\*) may require more technical information and tools. Consult your Honda dealer.

\* Should be serviced by your Honda dealer, unless you have the proper tools and service data and are mechanically qualified. Refer to the official Honda Service Manual (page 224).

\*\* In the interest of safety, we recommend these items be serviced only by your Honda dealer.

# Maintenance Schedule

---

## *Summary of Maintenance Schedule Notes & Procedures:*

### NOTES:

1. At higher odometer readings, repeat at the frequency interval established here.
2. Service more frequently if the motorcycle is ridden in unusually wet or dusty areas.
3. Replace every 2 years, or at indicated odometer interval, whichever comes first. Replacement requires mechanical skill. Refer to the official Honda service manual.
4. California type only.

### Maintenance Procedures:

I: inspect and clean, adjust, lubricate,  
or replace, if necessary

C: clean

A: adjust

L: lubricate

R: replace

# Maintenance Schedule

			FREQUENCY	ODOMETER READING (Note 1)								Refer to page
				× 1,000 mi	0.6	4	8	12	16	20	24	
ITEM		NOTE	× 1,000 km	1.0	6.4	12.8	19.2	25.6	32.0	38.4		
EMISSION RELATED ITEMS	*	FUEL LINE				I		I		I	—	
	*	THROTTLE OPERATION				I		I		I	116	
	*	AIR CLEANER	2					R			R	—
	*	SPARK PLUGS			EVERY 16,000 mi (25,600 km) I, EVERY 32,000 mi (51,200 km) R							—
	*	VALVE CLEARANCE							I			—
		ENGINE OIL			R		R		R		R	101
		ENGINE OIL FILTER			R		R		R		R	106
	*	ENGINE IDLE SPEED			I	I	I	I	I	I	I	120
		RADIATOR COOLANT	3				I		I		R	111
	*	COOLING SYSTEM					I		I		I	—
	*	SECONDARY AIR SUPPLY SYSTEM					I		I		I	—
	*	EVAPORATIVE EMISSION CONTROL SYSTEM	4					I			I	—
	**	EXHAUST GAS CONTROL VALVE CABLE			EVERY 16,000 mi (25,600 km) I							—

\* Should be serviced by your Honda dealer, unless you have the proper tools and service data and are mechanically qualified. Refer to the official Honda Service Manual (page 224 ).

\*\*In the interest of safety, we recommend these items be serviced only by your Honda dealer.

# Maintenance Schedule

ITEM		FREQUENCY	NOTE	ODOMETER READING (Note 1)								Refer to page	
				× 1,000 mi	0.6	4	8	12	16	20	24		
				× 1,000 km	1.0	6.4	12.8	19.2	25.6	32.0	38.4		
NON-EMISSION RELATED ITEMS		DRIVE CHAIN			EVERY 500 mi (800 km) I, L								145
		BRAKE FLUID	3			I	I	R	I	I	R	132	
		BRAKE PAD WEAR					I	I	I	I	I	135	
		BRAKE SYSTEM				I			I		I	131	
	*	BRAKE LIGHT SWITCH						I		I		—	
	*	HEADLIGHT AIM						I		I		—	
		CLUTCH SYSTEM				I	I	I	I	I	I	117	
		SIDE STAND						I		I		144	
	*	SUSPENSION						I		I		—	
	*	NUTS, BOLTS, FASTENERS				I		I		I		—	
	**	WHEELS/TIRES						I		I		—	
	**	STEERING HEAD BEARINGS				I		I		I		—	

\* Should be serviced by your Honda dealer, unless you have the proper tools and service data and are mechanically qualified. Refer to the official Honda Service Manual (page 224 ).

\*\*In the interest of safety, we recommend these items be serviced only by your Honda dealer.

## Maintenance Record

---

Keeping an accurate maintenance record will help ensure that your motorcycle is properly maintained. Retain detailed receipts to verify the maintenance was performed. If the motorcycle is sold, these receipts should be transferred with the motorcycle to the new owner. Make sure whoever performs the maintenance completes this record. All scheduled maintenance, including the 600 mile (1,000 km) initial maintenance, is considered a normal owner operating cost and will be charged for by your dealer. Use the space under Notes to record anything you want to remind yourself about or mention to your dealer.

<b>Miles (km)</b>	<b>Odometer</b>	<b>Date</b>	<b>Performed By:</b>	<b>Notes</b>
600 (1,000)				
4,000 (6,400)				
8,000 (12,800)				
12,000 (19,200)				
16,000 (25,600)				
20,000 (32,000)				

## Maintenance Record

---

<b>Miles (km)</b>	<b>Odometer</b>	<b>Date</b>	<b>Performed By:</b>	<b>Notes</b>
24,000 (38,400)				
28,000 (44,800)				
32,000 (51,200)				
36,000 (57,600)				
40,000 (64,000)				
44,000 (70,400)				
48,000 (76,800)				
52,000 (83,200)				
56,000 (89,600)				
60,000 (96,000)				
64,000 (102,400)				
68,000 (108,800)				

# Component Locations

---

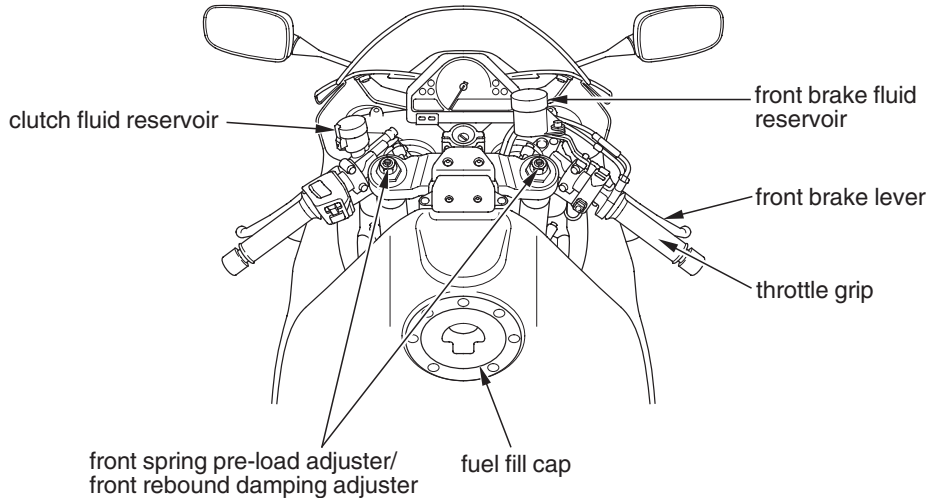



# Component Locations

---

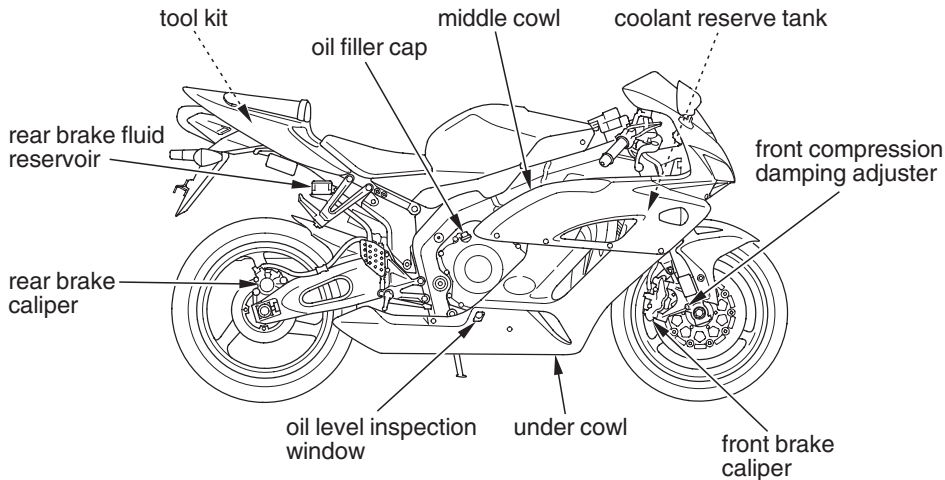

# Component Locations

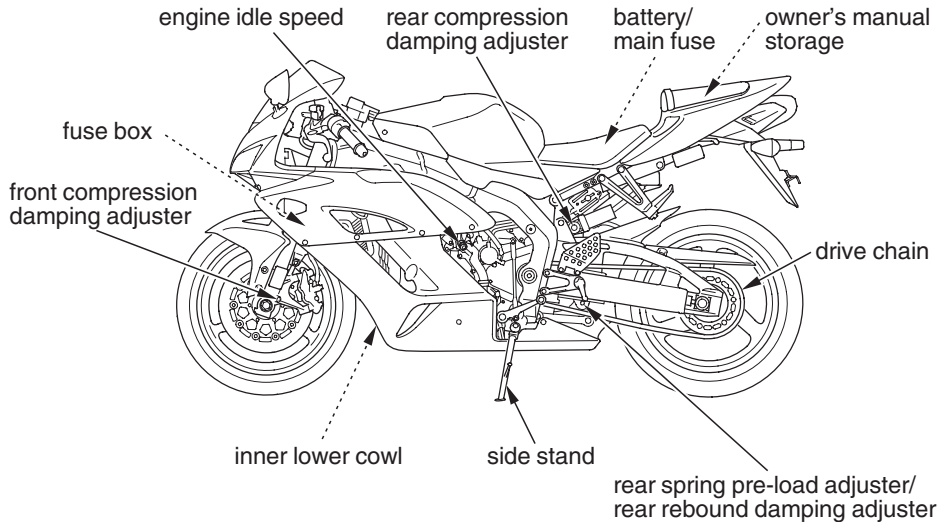

## Tool Kit

---

The tool kit is stored under the rear seat (page 93).

Some roadside repairs, minor adjustments, and parts replacement can be performed with the tools contained in the kit.

### UNDER REAR SEAT

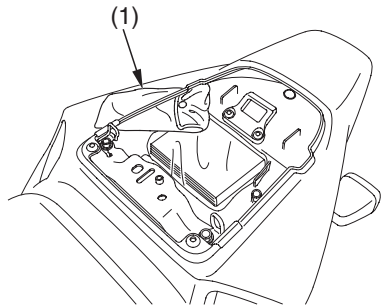

(1) tool kit

- 8 × 12 mm open end wrench
- 10 × 12 mm open end wrench
- 22 mm box end wrench
- 32 mm box end wrench
- 5 mm hex wrench
- pliers
- no. 2 Phillips screwdriver
- no. 2 screwdriver
- screwdriver handle
- extension bar
- spark plug wrench
- pin spanner
- 0.7 mm feeler gauge
- helmet holder wire
- tool bag

## Owner's Manual Storage

Your motorcycle provides storage for the owner's manual so you'll have it with you for easy reference. Store your owner's manual (and other documents) in the plastic storage bag (1) in the owner's manual storage compartment (2) under the rear seat (page 93 ).

Be careful not to flood this area when washing your motorcycle.

### UNDER REAR SEAT

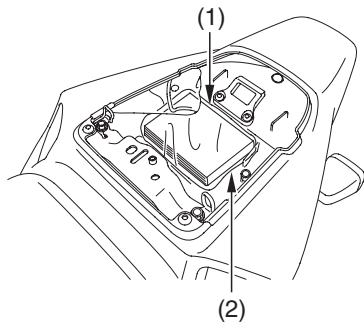

(1) storage bag

(2) owner's manual storage compartment

# Seat Removal

---

Refer to *Safety Precautions* on page 76 .

The front seat must be removed for battery or fuse maintenance.

## Front Seat Removal

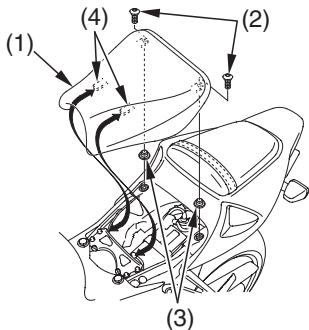

- |                    |             |
|--------------------|-------------|
| (1) front seat     | (3) collars |
| (2) mounting bolts | (4) tabs    |

To remove the front seat ( 1 ), pull the rear corners of the seat back, remove the two mounting bolts ( 2 ) and collars ( 3 ), and then pull the seat up and back.

To install the front seat, insert the tabs ( 4 ) into the recess under the frame and tighten the mounting bolts securely.

# Seat Removal

## Rear Seat Removal

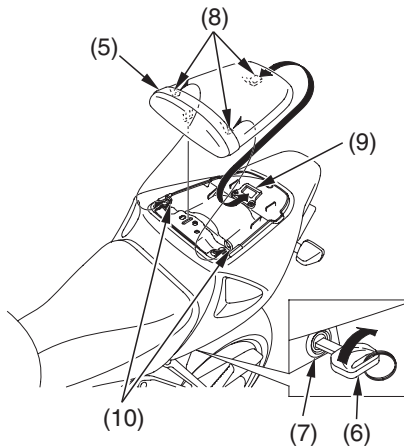

- (5) rear seat
- (6) ignition key
- (7) seat lock

- (8) prongs
- (9) seat hook
- (10) guide hooks

To remove the rear seat (5), insert the ignition key (6) into the seat lock (7). Turn it clockwise, then pull the rear seat forward and up.

To install the rear seat, insert the prongs (8) into the seat hook (9) and guide hooks (10), and then push down on the front of the rear seat.

## Middle Cowl Removal

---

Refer to *Safety Precautions* on page 76 .

The middle cowl must be removed to service the coolant reserve tank and fuse.

RIGHT SIDE (left side similar)

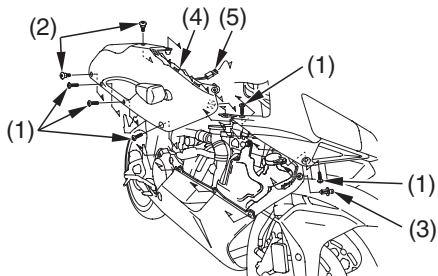

- |             |                  |
|-------------|------------------|
| (1) bolts A | (4) middle cowl  |
| (2) bolts B | (5) front turn   |
| (3) clip    | signal connector |

### Removal

1. Remove the bolts A (1), bolts B (2) and clip (3).
2. Remove the middle cowl (4) and disconnect the front turn signal connector (5).

### Installation

- Installation can be done in the reverse order of removal.

## Inner Lower Cowl Removal

Refer to *Safety Precautions* on page 76.

The inner lower cowl must be removed to remove the under cowl.

### Removal

Remove the bolt (1) and clips (2).

### Installation

- Installation can be done in the reverse order of removal.

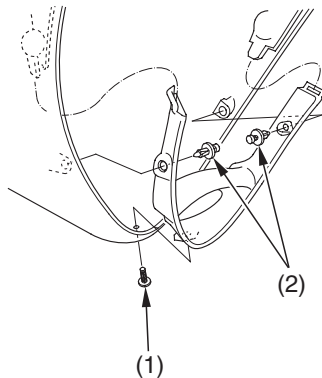

- (1) bolt
- (2) clips



# Under Cowl Removal

---

Refer to *Safety Precautions* on page 76.

The under cowl must be removed to replace the engine oil filter.

RIGHT SIDE (left side similar)

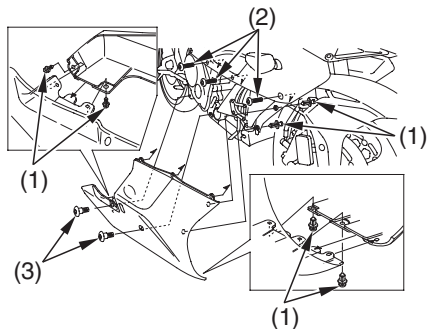

(1) clips

(2) bolts A

(3) bolts B

## Removal

1. Remove the inner lower cowl (page 95).
2. Remove the clips (1).
3. Remove the bolts A (2) and bolts B (3).

## Installation

- Installation can be done in the reverse order of removal.

Refer to *Safety Precautions* on page 76.

## Fuel Recommendation

type	premium unleaded
pump octane number	91 (or higher)

We recommend that you use premium unleaded fuel because it produces fewer engine deposits and extends the life of exhaust system components.

*California only:*

The use of leaded gas will damage the catalytic converter.

Your engine is designed to use any premium gasoline that has a pump octane number of 91 or higher. Gasoline pumps at service stations normally display the pump octane number. For information on the use of oxygenated fuels, see page 220.

## Fuel

---

Use of lower octane gasoline can cause persistent ‘‘pinging’’ or ‘‘spark knock’’ (a loud rapping noise) which, if severe, can lead to engine damage. Light pinging experienced while operating under a heavy load, such as climbing a hill, is no cause for concern.

If pinging or spark knock occurs at a steady engine speed under normal load, change brands of gasoline. If pinging or spark knock persists, consult your Honda dealer.

Never use stale or contaminated gasoline or an oil/gasoline mixture. Avoid getting dirt, dust, or water in the fuel tank.

## Fuel Capacity

Fuel tank capacity:  
4.76 US gal (18.0 l)

The tank should be refilled as soon as possible when the fuel indicator comes on.

## Refueling Procedure

Refer to *Safety Precautions* on page 76.

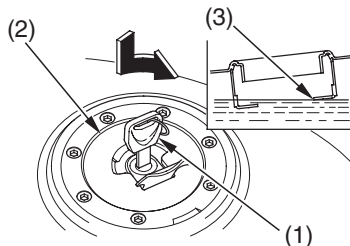

- (1) ignition key      (3) filler neck  
(2) fuel fill cap

1. Insert the ignition key (1) in the fuel fill cap (2) and turn it clockwise.

(cont'd)

# Fuel

---

2. Open the fuel fill cap.
3. Add fuel until the level reaches the bottom of the filler neck (3). Avoid overfilling the tank. There should be no fuel in the filler neck.
4. After refueling, push the fuel fill cap closed until it snaps and locks.
5. Remove the ignition key from the fuel fill cap.

## **WARNING**

Gasoline is highly flammable and explosive. You can be burned or seriously injured when handling fuel.

- Stop the engine and keep heat, sparks and flame away.
- Handle fuel only outdoors.
- Wipe up spills immediately.

## Engine Oil & Filter

---

Engine oil quality is a major factor that affects both the performance and the service life of the engine.

Using the proper oil (page 102 ) and filter, and regularly checking, adding, and changing oil will help extend your engine's life. Even the best oil wears out. Changing oil helps get rid of dirt and deposits in the engine. Operating the engine with old or dirty oil can damage your engine. Running the engine with insufficient oil can cause serious damage to the engine and transmission.

Change the engine oil as specified in the maintenance schedule on page 83 .

When running in very dusty conditions, oil changes should be performed more frequently than specified in the maintenance schedule.

## Engine Oil & Filter

---

### Oil Recommendation

API classification	SG or higher except oils labeled as energy conserving on the circular API service label
viscosity (weight)	SAE 10W-40
JASO T 903 standard	MA

#### suggested oil\*

Pro Honda GN4 or HP4 (without molybdenum additives) 4-stroke oil (USA & Canada), or Honda 4-stroke oil (Canada only), or an equivalent motorcycle oil.

- \* Suggested oils are equal in performance to SJ oils that are not labeled as energy conserving on the circular API service label.

## Engine Oil & Filter

- Your motorcycle does not need oil additives. Use the recommended oil.
- Do not use oils with graphite or molybdenum additives. They may adversely affect clutch operation.
- Do not use API SH or higher oils displaying a circular API “energy conserving” service label on the container. They may affect lubrication and clutch performance.



NOT RECOMMENDED



OK

- Do not use non-detergent, vegetable, or castor based racing oils.

Other viscosities shown in the following chart may be used when the average temperature in your riding area is within the indicated range.

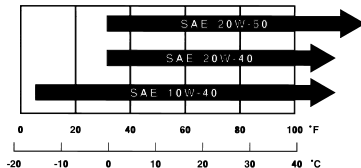



## Engine Oil & Filter

---

### JASO T 903 standard

The JASO T 903 standard is an index to choose engine oils for 4-stroke motorcycle engines.

There are two classes: MA and MB.

Oil conforming to the standard has the following classification on the oil container.

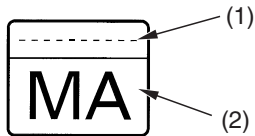

PRODUCT MEETING JASO T 903  
COMPANY GUARANTEEING THIS MA PERFORMANCE:

- (1) code number of the sales company of the oil
- (2) oil classification

# Engine Oil & Filter

## Checking & Adding Oil

Refer to *Safety Precautions* on page 76.

RIGHT SIDE

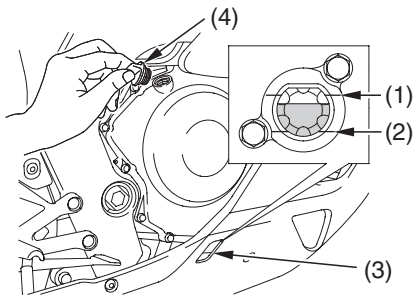

- (1) upper level mark      (4) oil filler cap  
(2) lower level mark  
(3) inspection window

1. Park your motorcycle on its side stand on a firm, level surface.
2. Start the engine and let it idle for 3-5 minutes. Make sure the malfunction indicator lamp (MIL) and low oil pressure indicator go off. If the indicators remain on, stop the engine immediately.
3. Stop the engine and wait 2–3 minutes.
4. Hold the motorcycle in an upright position.

(cont'd)

## Engine Oil & Filter

---

5. Check that the oil level is between the upper (1) and lower (2) level marks in the inspection window (3).
  - If the oil is at or near the upper level mark (1) — you do not have to add oil.
  - If the oil is below or near the lower level mark (2) — remove the oil filler cap (4) and add the recommended oil until it reaches the upper level mark. (Do not overfill.)
6. Reinstall the oil filler cap.
7. Check for oil leaks.

### Changing Engine Oil & Filter

Refer to *Safety Precautions* on page 76.

Your motorcycle's oil filter has very specific performance requirements. Use a new genuine Honda oil filter or a filter of equal quality specified for your model.

#### NOTICE

*Using the wrong oil filter may result in leaks or premature engine damage.*

## Engine Oil & Filter

This procedure requires mechanical skill and professional tools such as a torque wrench and oil filter wrench, as well as a means for disposing of the drained fluid (page 170). If you do not have the skills or the tools, see your Honda dealer.

### *Drain the Engine Oil:*

1. Park the motorcycle on its side stand on a firm, level surface.
2. If the engine is cold, start it and let it idle for 3–5 minutes. Turn the engine off. Wait 2–3 minutes for the oil to settle.
3. Place a drain pan under the crankcase drain bolt (1).

4. To drain the oil, remove the oil filler cap, crankcase drain bolt, and sealing washer (2).

### FRONT, UNDER ENGINE

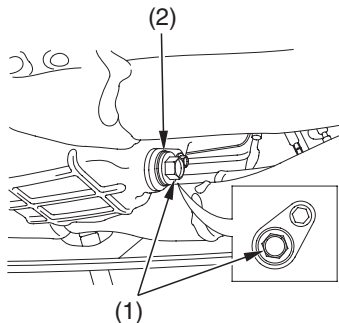

(1) crankcase  
drain bolt

(2) sealing washer

(cont'd)

## Engine Oil & Filter

---

### *Install a New Oil Filter:*

5. Remove the right under cowl (page 96 ).
6. Remove the oil filter (3) with a filter wrench and let the remaining oil drain out. Discard the oil filter in an approved manner (page 170).
7. Pour the drained oil into a suitable container and dispose of it in an approved manner (page 170).

### **NOTICE**

*Improper disposal of drained fluids is harmful to the environment.*

### RIGHT SIDE

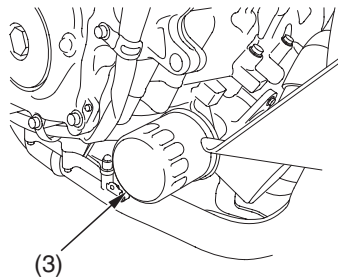

(3) oil filter

## Engine Oil & Filter

8. Apply a thin coat of engine oil to the rubber seal (4) of a new oil filter.

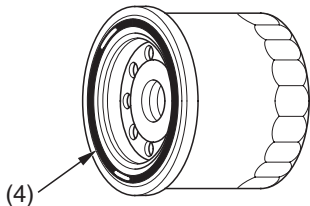

(4) oil filter rubber seal

9. Install the new oil filter and tighten it by hand.
10. Using an oil filter wrench attachment and a torque wrench, tighten the new oil filter to the specified torque:  
20 lbf·ft (26 N·m , 2.7 kgf·m)

11. Check the condition of the sealing washer on the drain bolt. Replace the washer every other time the oil is changed.

Install the drain bolt and tighten it to the specified torque:

22 lbf·ft (30 N·m , 3.0 kgf·m)

### *Add Engine Oil:*

12. Fill the crankcase with the recommended oil (page 102 ), approximately:  
3.3 US qt (3.1 ℓ)
13. Install the oil filler cap.

(cont'd)

## Engine Oil & Filter

---

14. Start the engine and let it idle for 3—5 minutes.
15. Stop the engine and wait 2—3 minutes.
16. Hold the motorcycle upright and check that the oil level is at the upper level mark in the inspection window (page 105).
17. Check that there are no oil leaks.
18. Install the right under cowl.

If a torque wrench is not used for installation, see your Honda dealer as soon as possible to verify proper assembly.

Your motorcycle's liquid cooling system dissipates engine heat through the coolant jacket that surrounds the cylinder and cylinder head.

Maintaining the coolant will allow the cooling system to work properly and prevent freezing, overheating, and corrosion.

### Coolant Recommendation

Use Pro Honda HP coolant or an equivalent high quality ethylene glycol antifreeze containing corrosion protection inhibitors specifically recommended for use in aluminum engines. Check the antifreeze container label.

Use only distilled water as a part of the coolant solution. Water that is high in mineral content or salt may be harmful to the aluminum engine.

#### NOTICE

*Using coolant with silicate inhibitors may cause premature wear of water pump seals or blockage of radiator passages. Using tap water may cause engine damage.*

The factory provides a 50/50 solution of antifreeze and water in this motorcycle. This coolant solution is recommended for most operating temperatures and provides good corrosion protection.



## Coolant

Decreasing the concentration of antifreeze to less than 40% will not provide proper corrosion protection.

Increasing the concentration of antifreeze is not recommended because it decreases cooling system performance. Higher concentrations of antifreeze (up to 60%) should only be used to provide additional protection against freezing. Check the cooling system frequently during freezing weather.

### Checking & Adding Coolant

Refer to *Safety Precautions* on page 76 .

#### RIGHT SIDE

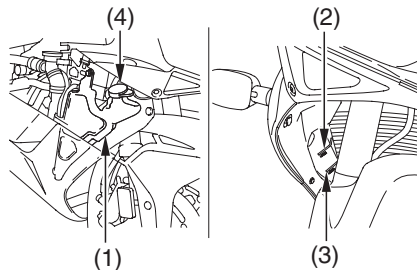

- (1) reserve tank
- (2) UPPER level mark
- (3) LOWER level mark
- (4) reserve tank cap

1. With the engine at normal operating temperature, check the coolant level in the reserve tank ( 1 ). It should be between the UPPER ( 2 ) and LOWER ( 3 ) level marks.  
If the reserve tank is empty, or if coolant loss is excessive, check for leaks and see your Honda dealer for repair.
2. Remove the right middle cowl (page 94 ) and the reserve tank cap ( 4 ).  
Always add coolant to the reserve tank.  
Do not attempt to add coolant by removing the radiator cap.
3. Add coolant to the reserve tank as required to bring the coolant level to the UPPER level mark.

### Coolant Replacement

Refer to *Safety Precautions* on page 76 .

Coolant should be replaced by your Honda dealer, unless you have the proper tools and service data and are mechanically qualified. Refer to the official Honda Service Manual (page 224 ).

## Coolant

---

### **WARNING**

Removing the radiator cap while the engine is hot can cause the coolant to spray out, seriously scalding you.

Always let the engine and radiator cool down before removing the radiator cap.

To properly dispose of drained coolant, refer to *You & the Environment*, page 170 .

### **NOTICE**

*Improper disposal of drained fluids is harmful to the environment.*

## Throttle Freeplay

Refer to *Safety Precautions* on page 76.

### RIGHT HANDLEBAR

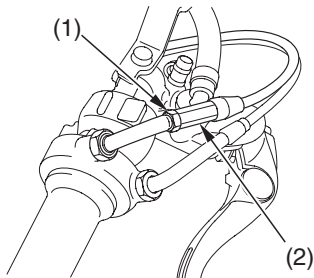

(1) lock nut

(2) adjuster

### Inspection

Check freeplay at the throttle grip flange.

Freeplay:

1/16 in (2 mm)

If necessary, adjust to the specified range.

### Adjustment

1. Loosen the lock nut (1).
2. Turn the adjuster (2).
3. After adjustment, check for smooth rotation of the throttle grip from fully closed to fully open in all steering positions.

# Throttle

---

## Throttle Inspection

Refer to *Safety Precautions* on page 76.

1. Check that the throttle assembly is positioned properly and the securing bolts are tight.
2. Check for smooth rotation of the throttle from fully open to fully closed in all steering positions. If there is a problem, see your Honda dealer.

# Clutch System

Your motorcycle has a hydraulically-actuated clutch. There are no adjustments to perform, but the clutch system must be inspected periodically for fluid level and leakage.

If control lever freeplay becomes excessive and the motorcycle creeps or stalls when shifted into gear, or if the clutch slips, causing acceleration to lag behind engine speed, there is probably air in the clutch system. See your Honda dealer to have the air bled out of the system.

## Clutch Lever Adjustment

Refer to *Safety Precautions* on page 76 .

The distance between the tip of the clutch lever and the grip may be adjusted.

### LEFT HANDLEBAR

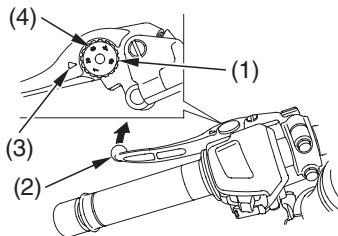

- |                   |                |
|-------------------|----------------|
| (1) adjuster dial | (3) index mark |
| (2) clutch lever  | (4) numbers    |

## Clutch System

---

1. Turn the adjuster dial ( 1 ) while pushing the clutch lever ( 2 ) forward.
2. Align the index mark ( 3 ) on the clutch lever with the numbers ( 4 ) on the adjuster dial.
3. Start the engine, pull the clutch lever in, and shift into gear. Make sure the engine does not stall and the motorcycle does not creep. Gradually release the clutch lever and open the throttle. Your motorcycle should move smoothly and accelerate gradually.

### Fluid Level Inspection

Refer to *Safety Precautions* on page 76 .

#### LEFT HANDLEBAR

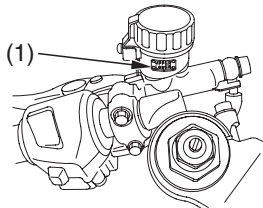

#### (1) LOWER level mark

Check that the fluid level is above the LOWER level mark. If the fluid level is below the LOWER level mark, it indicates fluid leakage. See your Honda dealer for repair.

### Other Inspections

- Make sure there are no fluid leaks.
- Check for deterioration or cracks in the hose and fittings.
- Check that the clutch lever assembly is positioned properly and the securing bolts are tight.



## Engine Idle Speed

---

Remember, idle speed adjustment is not a “cure-all” for other problems in your engine’s fuel-delivery system. Adjusting the idle will not compensate for a fault elsewhere.

The engine must be at normal operating temperature for accurate idle speed adjustment.

### Idle Speed Adjustment

Refer to *Safety Precautions* on page 76.

#### LEFT SIDE

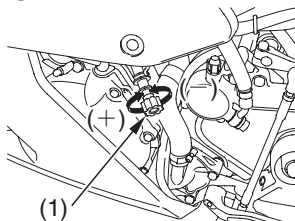

(1) throttle stop  
screw

(+) increase  
(-) decrease

1. If the engine is cold, start it and warm it up with ten minutes of stop-and-go riding. Stop the engine.

## Engine Idle Speed

---

2. Place your motorcycle on its side stand on a firm, level surface.
3. Shift into neutral. Start the engine.
4. Adjust idle speed with the throttle stop screw (1).

Idle speed (in neutral):

1,200  $\pm$  100 rpm

## Suspension

---

Your front and rear suspension systems use springs, hydraulic damping devices, and linkages (rear only) that suspend your weight and most of the weight of your motorcycle.

The spring pre-loads for your front and rear suspension systems adjust the amount of force required to begin compression of the spring.

The oil damper systems hydraulically control the natural compression and rebound of the suspension springs so that traction and comfort are maintained as the wheels ride over road surfaces.

Consider adjusting your suspension whenever you change your normal load, by adding or subtracting a passenger, cargo, or accessories, or when the road or riding conditions change.

The way you ride your motorcycle and the type of ride you want to experience can also influence your suspension needs.

You may adjust the spring pre-load and the rebound and compression damping of both suspension systems.

Lower spring pre-load and softer damping provide a softer ride and are usually preferred for light loads and smooth roads. Higher spring pre-load and firmer damping provide a firmer ride and are recommended for heavy loads, rough road conditions, and faster, more challenging riding.

### **Front Suspension Adjustment**

The front suspension can be adjusted for rider (and passenger) weight and riding conditions by changing the spring pre-load and rebound and compression damping.

# Suspension

## Front Suspension Spring Pre-load

Refer to *Safety Precautions* on page 76 .

FRONT

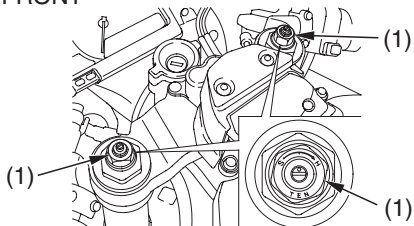

(1) pre-load adjuster

Adjust the spring pre-load by turning the pre-load adjuster ( 1 ) with the 22 mm wrench provided in the tool kit.

To adjust to the standard position:

1. Turn the pre-load adjuster ( 1 ) counterclockwise until it will no longer turn (lightly seats). This is the full soft setting.
2. Turn the adjuster clockwise 7 turns. This is the standard position.
3. Make sure that both fork legs are adjusted to the same position.

*To Reduce Spring Pre-load (SOFT):*

For a light load and smooth road conditions, turn the adjuster counterclockwise toward SOFT.

*To Increase Spring Pre-load (HARD):*

For a firmer ride and rough road conditions, turn the adjuster clockwise toward HARD.

## Front Suspension Damping

Refer to *Safety Precautions* on page 76.

### Rebound Damping

#### FRONT

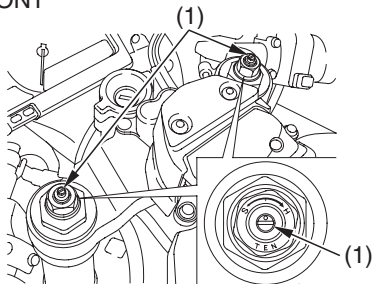

(1) damping adjuster

To adjust to the standard position:

1. Turn the rebound damping adjuster (1) clockwise until it will no longer turn (lightly seats). This is the full hard setting.
2. Turn the adjuster counterclockwise 2 turns. This is the standard position.
3. Make sure that both fork legs are adjusted to the same position.

*To Reduce Rebound Damping (SOFT):*

For a light load and smooth road conditions, turn the adjuster counterclockwise toward SOFT (S).

*To Increase Rebound Damping (HARD):*

For a firmer ride and rough road conditions, turn the adjuster clockwise toward HARD (H).

# Suspension

---

## Compression Damping

### RIGHT SIDE

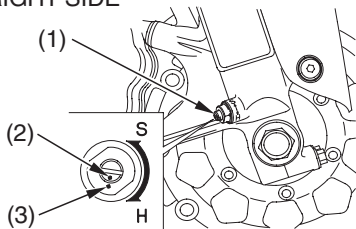

- (1) damping adjuster
- (2) punch mark
- (3) reference punch mark

To adjust to the standard position:

1. Turn the damping adjuster (1) clockwise until it will no longer turn (lightly seats). This is the full hard setting.

2. Turn the adjuster counterclockwise approximately 2 turns so that the punch mark (2) on the adjuster aligns with the reference punch mark (3). This is the standard position.
3. Make sure that both fork legs are adjusted to the same position.

### *To Reduce Compression Damping (SOFT):*

For a light load and smooth road conditions, turn the adjuster counterclockwise toward SOFT.

### *To Increase Compression Damping (HARD):*

For a firmer ride and rough road conditions, turn the adjuster clockwise toward HARD.

### Rear Suspension Adjustment

The rear suspension can be adjusted for rider (and passenger) weight and riding conditions by changing the spring pre-load and rebound and compression damping.

The rear shock absorber includes a damper unit that contains high pressure nitrogen gas. Do not attempt to disassemble, service, or dispose of the damper; see your Honda dealer. The instructions found in this owner's manual are limited to adjustments of the shock assembly only.



# Suspension

## Rear Suspension Spring Pre-load

Refer to *Safety Precautions* on page 76.

LEFT SIDE

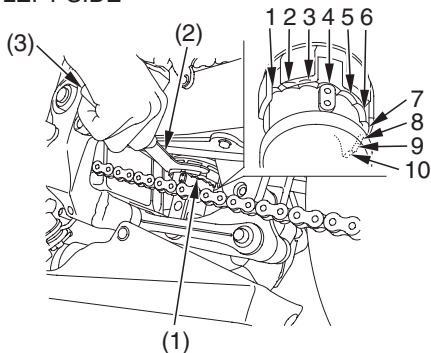

- (1) spring pre-load adjuster  
(2) pin spanner      (3) extension bar

The spring pre-load adjuster (1) has 10 positions for different load or riding conditions.

Use the pin spanner (2) and extension bar (3) to adjust the rear shock spring pre-load.

Positions 1 to 3: for a light load and smooth road conditions.

Position 4: standard position.

Positions 5 to 10: for when the motorcycle is more heavily loaded. (Also increase spring pre-load for stiffer rear suspension.)

Always adjust the shock absorber position in sequence (1-2-3-4-5-6-7-8-9-10 or 10-9-8-7-6-5-4-3-2-1). Attempting to adjust directly from 1 to 10 or 10 to 1 may damage the shock absorber.

## Rear Suspension Damping

Refer to *Safety Precautions* on page 76.

### Rebound Damping

#### LEFT SIDE

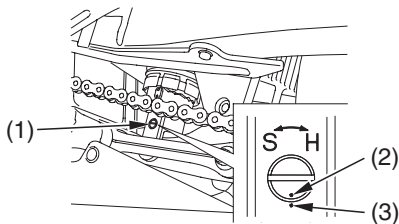

- (1) damping adjuster
- (2) punch mark
- (3) reference punch mark

To adjust to the standard position:

1. Turn the damping adjuster (1) clockwise until it will no longer turn (lightly seats). This is the full hard setting.
2. Turn the adjuster counterclockwise approximately 2 1/2 turns so that the punch mark (2) on the adjuster aligns with the reference punch mark (3). This is the standard position.

#### *To Reduce Rebound Damping (SOFT):*

For a light load and smooth road conditions, turn the adjuster counterclockwise toward SOFT (S).

#### *To Increase Rebound Damping (HARD):*

For a firmer ride and rough road conditions, turn the adjuster clockwise toward HARD (H).

# Suspension

---

## Compression Damping

### LEFT SIDE

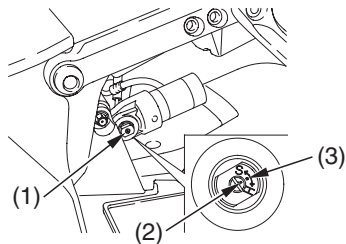

- (1) damping adjuster
- (2) punch mark
- (3) reference punch mark

To adjust to the standard position:

1. Turn the damping adjuster (1) clockwise until it will no longer turn (lightly seats). This is the full hard setting.

2. Turn the adjuster counterclockwise 9 clicks so that the punch mark (2) on the adjuster aligns with the reference punch mark (3). This is the standard position.

### *To Reduce Compression Damping (SOFT):*

For a light load and smooth road conditions, turn the adjuster counterclockwise toward SOFT.

### *To Increase Compression Damping (HARD):*

For a firmer ride and rough road conditions, turn the adjuster clockwise toward HARD.

The hydraulic braking systems on your motorcycle dissipate the heat generated by the friction of the brake pads on the brake discs as the wheels are slowed.

As the brake pads wear, the brake fluid level will drop. A leak in the system will also cause the level to drop.

Frequently inspect the system to ensure there are no fluid leaks. Periodically inspect the brake fluid level and the brake pads for wear.

If the brake lever or brake pedal freeplay does not feel within the normal range while riding, check the brake pads for wear (page 135 ). Worn pads should be replaced. If the pads are not worn beyond the recommended limit, there is probably

air in the brake system. See your Honda dealer to have the air bled from the system.

### Front Brake Lever Adjustment

Refer to *Safety Precautions* on page 76 .

The distance between the tip of the brake lever and the grip may be adjusted.

#### RIGHT HANDLEBAR

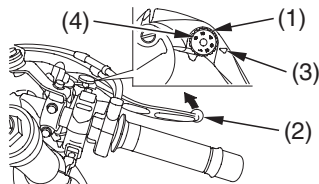

- (1) adjuster dial                      (3) index mark  
(2) brake lever                        (4) numbers

# Brakes

---

1. Turn the adjuster dial ( 1 ) while pushing the brake lever ( 2 ) forward.
2. Align the index mark ( 3 ) on the brake lever with the numbers ( 4 ) on the adjuster dial.
3. Apply the brake, release it, then spin the wheel and check that it rotates freely. Repeat this procedure several times.

## Brake Fluid Recommendation

brake fluid	Honda DOT 4 Brake Fluid
----------------	----------------------------

The recommended brake fluid is Honda DOT 4 Brake Fluid, or any brake fluid of equal quality and performance. Use fresh brake fluid from a sealed container. Be sure to read the label before opening the sealed container. An opened container may be contaminated or may have absorbed moisture from the air.

## Fluid Level Inspection

Refer to *Safety Precautions* on page 76.

If your inspection indicates a low fluid level, have your Honda dealer add the recommended brake fluid.

Do not add or replace brake fluid, except in an emergency. If you do add fluid, have your Honda dealer check the system as soon as possible.

### NOTICE

*Brake fluid can damage plastic and painted surfaces. Handle with care.*

Wipe up spills immediately. Avoid contact with skin or eyes. In case of contact, wash thoroughly and call a doctor immediately if it contacts your eyes.

### RIGHT FRONT

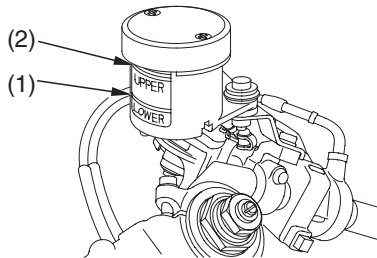

- (1) LOWER level mark
- (2) UPPER level mark

# Brakes

---

## RIGHT SIDE

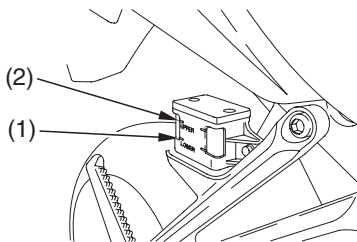

- (1) LOWER level mark  
(2) UPPER level mark

1. Place your motorcycle in an upright position on a firm, level surface.
2. Check the fluid level. It should be between the UPPER (2) and LOWER (1) level marks. If the level is at or below the LOWER level mark, check the brake pads for wear (page 136).

Worn pads should be replaced. If the pads are not worn beyond the recommended limit, have your brake system inspected for leaks.

### Other Inspections

- Make sure there are no fluid leaks.
- Check for deterioration or cracks in the hoses and fittings.

## Brake Pad Wear

Refer to *Safety Precautions* on page 76.

Brake pad wear depends upon the severity of usage, the type of riding, and road conditions. Generally, the pads will wear faster on wet and dirty roads. Inspect the pads at each regular maintenance interval (page 84).

Always inspect both pads in both the right and left front brake calipers.

### Front Brake

LEFT FRONT (Right side similar)

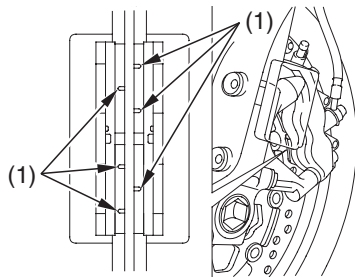

(1) wear indicator grooves

Check the grooves (1) in each pad. If either pad is worn to the bottom of the grooves, replace both pads as a set. See your Honda dealer for this service.



# Brakes

---

## Rear Brake

### RIGHT REAR

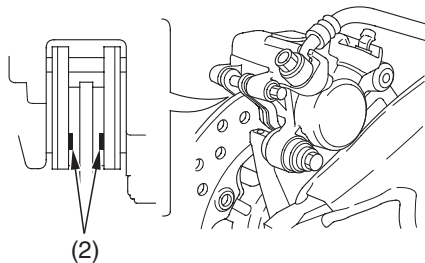

(2) cutouts

Check the cutouts (2) in each pad. If either pad is worn to the cutout, replace both pads as a set. See your Honda dealer for this service.

To safely operate your motorcycle, your tires must be the proper type and size, in good condition with adequate tread, and correctly inflated for the load you are carrying.

## **WARNING**

Using tires that are excessively worn or improperly inflated can cause a crash in which you can be seriously hurt or killed.

Follow all instructions in this owner's manual regarding tire inflation and maintenance.

The following pages give detailed information on how and when to check

your air pressure, how to inspect your tires for wear and damage, and our recommendations for tire repair and replacement.

## **Air Pressure**

Refer to *Safety Precautions* on page 76 .

Properly inflated tires provide the best combination of handling, tread life, and riding comfort. Generally, underinflated tires wear unevenly, adversely affect handling, and are more likely to fail from being overheated. Overinflated tires make your motorcycle ride more harshly, are more prone to damage from road hazards, and wear unevenly.

# Tires

---

We recommend that you visually check your tires before every ride and use an air pressure gauge to measure the air pressure at least once a month or any time you think the tires might be low. Even tires that are in good condition may lose one to two psi per month if not checked and adjusted regularly.

Tubeless tires have some degree of self-sealing ability if they are punctured. However, because leakage is often very slow, you should look closely for punctures whenever a tire is not fully inflated.

Always check air pressure when your tires are “cold” — after the motorcycle has been parked for at least three hours. If you check air pressure when your tires are

“warm” — even if your motorcycle has only been ridden for a few miles — the readings will be higher. If you let air out of warm tires to match the recommended cold pressures, the tires will be underinflated.

The recommended “cold” tire pressures are:

front	36 psi (250 kPa , 2.50 kgf/cm <sup>2</sup> )
rear	42 psi (290 kPa , 2.90 kgf/cm <sup>2</sup> )

## Inspection

Refer to *Safety Precautions* on page 76.

Whenever you check the tire pressures, you should also look for:

- Bumps or bulges in the side of the tire or the tread. Replace any tire that has a bump or bulge.
- Cuts, slits, or cracks in the tires. Replace the tire if you can see fabric or cord.
- Nails or other foreign objects embedded in the side of the tire or tread.
- Excessive tread wear.

Also, if you hit a pothole or hard object while riding, pull to the side of the road as soon as you safely can and carefully inspect the tires for damage.

## Tread Wear

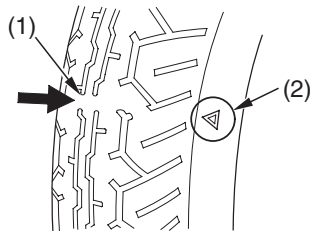

- (1) wear indicator  
(2) wear indicator location mark

# Tires

---

For the best performance, you should replace a tire before the tread depth at the center reaches the following limits:

front	0.06 in (1.5 mm)
rear	0.08 in (2.0 mm)

If the wear indicators are visible, replace the tire immediately as it is no longer safe.

## Tire Repair

Refer to *Safety Precautions* on page 76.

We strongly recommend that you replace, not repair, any tire that is punctured or damaged. As discussed below, a tire that is repaired, either temporarily or permanently, will have lower speed and performance limits than a new or undamaged tire.

A temporary repair can sometimes be made in an emergency situation.

However, since a temporary repair may not hold, you must ride very slowly, preferably without any cargo or passenger, and have the tire replaced or permanently repaired as soon as possible.

(For more information on temporary repairs, see *If You Have a Flat Tire*, page 178 .)

A permanent repair, such as an internal plug patch, can be made if a tire has only a small puncture in the tread area. With such a repair, you should not exceed 50 mph (80 km/h) for the first 24 hours, or 80 mph (130 km/h) at any time thereafter. In addition, you may not be able to safely carry as much weight. If you choose to have a tire repaired, be sure the repair work is performed by a professional and that the wheel is balanced before you ride.

If you have a tire professionally repaired at a non-Honda facility, we recommend that you have the work checked by your Honda dealer.

## Tire Replacement

Refer to *Safety Precautions* on page 76 .

The tires that came on your motorcycle were designed to match the performance capabilities of your motorcycle and provide the best combination of handling, braking, durability, and comfort.

# Tires

You should replace the tires with tires of the same size, load range, and speed rating as the originals.

## **WARNING**

Installing improper tires on your motorcycle can affect handling and stability. This can cause a crash in which you can be seriously hurt or killed.

Always use the size and type of tires recommended in this owner's manual.

The recommended tires for your motorcycle are:

front	120/70ZR17M/C (58W) BRIDGESTONE BT014F RADIAL G PIRELLI DIABLO CORSA H
rear	190/50ZR17M/C (73W) BRIDGESTONE BT014R RADIAL G PIRELLI DIABLO CORSA H
type	radial, tubeless

Whenever you replace a tire, remember:

- Have the wheel balanced after the tire is installed.
- Have the tire replaced by your Honda dealer if possible.

If you have a tire professionally replaced at a non-Honda facility, we recommend that you have the work checked by your Honda dealer.

### Important Safety Reminders

- Do not install a tube inside a tubeless tire on this motorcycle. Excessive heat build-up can cause the tube to burst.
- Use only tubeless tires on this motorcycle. The rims are designed for tubeless tires, and during hard acceleration or braking, a tube-type tire could slip on the rim and cause the tire to rapidly deflate.
- Do not install a bias-ply tire on this motorcycle. Mixing bias-ply and radial tires can adversely affect handling and stability.



## Side Stand

---

Refer to *Safety Precautions* on page 76.

### LEFT SIDE

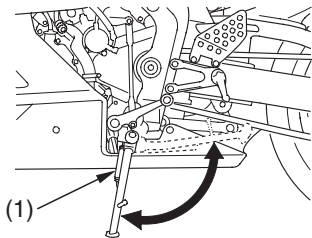

(1) side stand spring

- Check that the side stand assembly is working properly. If the side stand is stiff or squeaky, clean the pivot area and lubricate the pivot bolt with clean grease.

- Check the spring for damage or loss of tension.
- Check the side stand ignition cut-off system:
  1. Sit astride the motorcycle and put the transmission in neutral.
  2. Raise the side stand.
  3. Start the engine.
  4. Pull the clutch lever in.
  5. Shift the transmission into gear.
  6. Lower the side stand all the way.The engine should stop as you lower the side stand. If the engine doesn't stop, see your Honda dealer for service.

An endless (riveted master link) chain connects the countershaft and rear wheel sprockets. The O-ring chain uses rubber rings between the side plates of the pin and roller links to seal in the manufacturer-installed lubricating grease and keep out moisture and dirt.

The service life of the chain depends on proper lubrication and adjustment. Poor maintenance can cause premature wear or damage to the drive chain or sprockets.

The drive chain should be checked, adjusted, and lubricated as part of the pre-ride inspection (page 49 ).

Under severe usage, or when the motorcycle is ridden in unusually dusty or muddy areas, more frequent maintenance will be necessary.

Before servicing your drive chain, turn the engine OFF, lower the side stand, and check that your transmission is in neutral.

It is not necessary to remove or replace the drive chain to perform the recommended service in the Maintenance Schedule.

# Drive Chain

## Inspection

Refer to *Safety Precautions* on page 76 .

1. Check slack in the lower drive chain  
(1) run midway between the sprockets.  
Drive chain slack should allow the following vertical movement by hand:  
1 – 1 3/8 in (25 – 35 mm)
2. Check drive chain slack at several points along the chain. The slack should remain constant. If it isn't, some links may be kinked and binding. Lubricating the chain will often eliminate binding and kinking.

LEFT SIDE

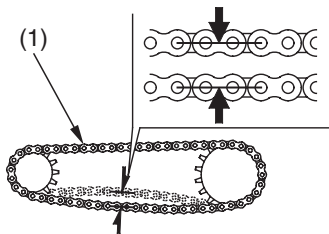

(1) drive chain

3. Inspect the drive chain for:
  - damaged rollers
  - dry or rusted links
  - kinked or binding links
  - excessive wear
  - improper adjustment
  - damaged or missing O-rings

## Drive Chain

Replace the drive chain (page 151 ) if it has damaged rollers, loose pins, or kinks that cannot be freed. Lubricate the drive chain (page 150 ) if it appears dry or shows signs of rust. Lubricate any kinked or binding links and work them free. Adjust chain slack if needed.

4. Inspect the front and rear sprocket teeth for excessive wear or damage. If necessary, have your Honda dealer replace a worn sprocket.

damaged  
sprocket  
teeth

worn  
sprocket  
teeth

REPLACE

REPLACE

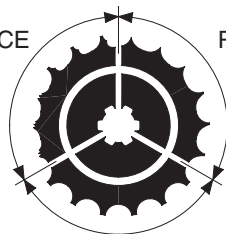

normal sprocket teeth  
GOOD

### NOTICE

*Use of a new chain with worn sprockets will cause rapid chain wear.*

# Drive Chain

## Wear Inspection

### LEFT SIDE

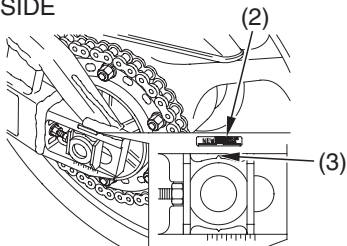

(2) red zone

(3) index mark

Check the chain wear label when adjusting the chain. If the red zone (2) on the label aligns with the index mark (3) on the chain adjustment plate after the chain has been adjusted to the proper slack, the chain is excessively worn and must be replaced. The proper slack is:  
1 – 1 3/8 in (25 – 35 mm)

The bottom part of the frame may be damaged by excessive drive chain slack of more than:

1 15/16 in (50 mm)

## Adjustment

Refer to *Safety Precautions* on page 76.

Drive chain slack should be checked and adjusted, if necessary, every 500 miles (800 km). When operated at sustained high speeds or under conditions of frequent rapid acceleration, the chain may require more frequent adjustments.

## Drive Chain

### RIGHT SIDE

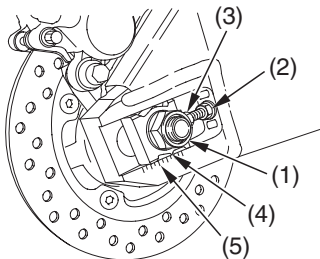

- |                                |                               |
|--------------------------------|-------------------------------|
| (1) rear axle nut              | (4) chain adjuster index mark |
| (2) lock nut                   | (5) scale                     |
| (3) drive chain adjusting bolt |                               |

1. Place the motorcycle on its side stand with the transmission in neutral and the ignition switch OFF.
2. Loosen the rear axle nut (1).

3. Loosen the lock nuts (2) on both sides of the swingarm.
4. Turn both drive chain adjusting bolts (3) an equal number of turns until the correct drive chain slack is obtained. Turn the drive chain adjusting bolts counterclockwise to tighten the chain, Turn the drive chain adjusting bolts clockwise and push the rear wheel toward the front to provide more slack. Adjust the chain slack at a point midway between the drive sprocket and the rear wheel sprocket. Roll the motorcycle forward. Stop and place it on its side stand. Recheck chain slack. Chain slack should allow the following vertical movement by hand:  
1 – 1 3/8 in (25 – 35 mm)

(cont'd)

## Drive Chain

---

5. Check rear axle alignment by making sure the chain adjuster index mark (4) aligns with the scale (5) graduations on both sides of the swingarm. Both marks should correspond. If the axle is misaligned, turn the right or left adjusting bolt until the marks are aligned and recheck chain slack.
6. Torque the rear axle nut to:  
**83 lbf·ft (113 N·m , 11.5 kgf·m)**  
If a torque wrench is not used for this installation, see your Honda dealer as soon as possible to verify proper assembly. Improper assembly may lead to a loss of braking capacity.

7. Tighten the drive chain adjusting bolts lightly by turning it counterclockwise, then tighten the lock nuts by holding the drive chain adjusting bolts with a wrench.
8. Recheck drive chain slack (page 146 ).

### Lubrication

Refer to *Safety Precautions* on page 76 .

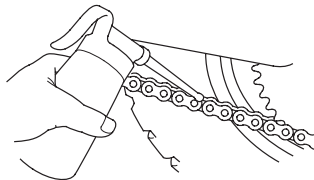

Lubricate every 500 miles (800 km) or sooner if chain appears dry. Lubricant: SAE 80 or 90 gear oil

Lubricate only with SAE 80 or 90 gear oil. Commercial chain lubricants may contain solvents which could damage the rubber O-rings.

### Removal, Cleaning & Replacement

Refer to *Safety Precautions* on page 76.

Your motorcycle has an endless (riveted master link) type chain. It should only be removed or replaced by your Honda dealer.

The O-rings can be damaged by steam cleaning, high pressure washers, and certain solvents.

1. Clean the side surfaces of the chain with a dry cloth. Use a high flashpoint solvent such as kerosene — not gasoline.

Do not brush the rubber O-rings. Brushing will damage them. Use of a solvent may also damage the O-rings.

2. Inspect the drive chain for possible wear or damage.

Replace the drive chain if it has damaged rollers, loose fitting links, damaged O-rings, or otherwise appears unserviceable.

Replacement Chain:

DID 50VM2

or

RK 50GFOZ1



# Battery

---

Your motorcycle has a maintenance-free type battery. You do not have to check the battery electrolyte level or add distilled water as you would with a conventional-type battery.

## NOTICE

*Your battery is a maintenance-free type and can be permanently damaged if the cap strip is removed.*

Electrical accessories use current from the battery — even when the ignition is OFF. Limited operation also allows the battery to discharge. If you have electrical accessories on your motorcycle — or do not ride frequently, we recommend that you charge the battery frequently (see *Battery Charging*, page 155 ).

If you do not expect to ride your motorcycle for at least two weeks, we recommend you remove the battery — or at least disconnect the battery cables (negative cable first).

If you plan to store your motorcycle, see *Battery Storage*, page 153 .

If your battery seems weak and/or is leaking electrolyte (causing slow starting or other electrical problems), see your Honda dealer.

**WARNING:** Battery posts, terminals and related accessories contain lead and lead compounds. **Wash hands after handling.**

## Battery Storage

Refer to *Safety Precautions* on page 76 .

If you plan to store your motorcycle, we recommend you remove the battery and store it where it can be charged at least every 30 days to maintain its service life.

If you do not remove the battery, we recommend disconnecting the battery cables (negative cable first).

You will get the best storage results from removing the battery and slow (trickle) charging it every 30 days (see *Battery Charging*, page 155).

Before you remove the battery, be sure to read all the information that follows, as well as the information on the battery label.

### **WARNING**

The battery gives off explosive hydrogen gas during normal operation.

A spark or flame can cause the battery to explode with enough force to kill or seriously hurt you.

Wear protective clothing and a face shield, or have a skilled mechanic do the battery maintenance.

## Battery

---

The battery is located in the battery box below the front seat.

1. Remove the front seat (page 92).
2. Release the ring (1) and remove the rubber band (2).

### UNDER SEAT

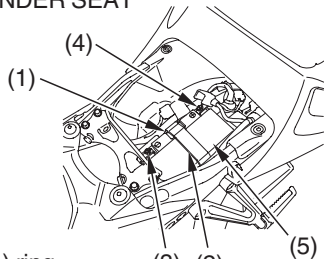

- (1) ring
- (2) rubber band
- (3) negative (−) terminal lead
- (4) positive (+) terminal lead
- (5) battery

3. Disconnect the negative (−) terminal lead (3) from the battery first, then disconnect the positive (+) terminal lead (4).
4. Pull the battery (5) out of the battery box.

- Charge the battery (see following section), unless you have been riding regularly.
- Store your battery in an easy-to-reach location off the floor, in an area protected from freezing temperatures and direct sunlight.
- Clean the battery box after removing the battery for storage. Dry the battery box and, if paint is missing, re-paint the area.
- Slow charge the battery (see following section) once every 30 days.

### Battery Charging

Refer to *Safety Precautions* on page 76.

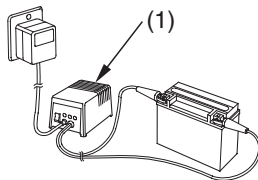

(1) “trickle” charger

Be sure to read the information that came with your battery charger and follow the instructions on the battery. Improper charging may damage the battery.

## Battery

---

We recommend using a “trickle” charger (1) for home charging. These units can be left connected for long periods without risking damage to the battery. However, do not intentionally leave the charger connected longer than the time period recommended in the charger’s instructions.

Avoid using an automotive-type battery charger. An automotive charger can overheat a motorcycle battery and cause permanent damage.

Frequent cleaning and polishing will keep your Honda looking newer longer. Frequent cleaning also identifies you as an owner who values your motorcycle. A clean motorcycle is also easier to inspect and service.

### General Recommendations

Refer to *Safety Precautions* on page 76.

- To clean your motorcycle, you may use:
  - water
  - a mild, neutral detergent and water
  - a mild spray and wipe cleaner/polisher
  - a mild spray and rinse cleaner/degreaser and water

- Avoid products that contain harsh detergents or chemical solvents that could damage the metal, paint, and plastic on your motorcycle.
- If your motorcycle is still warm from recent operation, give the engine and exhaust system time to cool off.
- Park in a shady area. Washing your motorcycle in bright sunlight may cause the finish to fade because water droplets intensify the sun's brightness. Spotting is also more likely because surface water can dry before you have time to wipe it off.
- Clean your motorcycle regularly to protect surface finishes.

(cont'd)

## Appearance Care

---

- We recommend the use of a garden hose to wash your motorcycle. High pressure washers (like those at coin-operated car washes) can damage certain parts of your motorcycle.
- Do not direct water at the air intake (1). The water could enter the air cleaner or be drawn into the throttle body.

### NOTICE

*High pressure water (or air) can damage certain parts of your motorcycle.*

FRONT

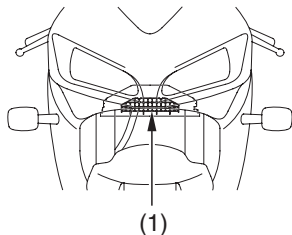

(1) air intake

- After cleaning, inspect for damage, wear, and leaks (fuel, oil, coolant, and brake fluid).

### Washing Your Motorcycle with a Mild Detergent

Refer to *Safety Precautions* on page 76.

1. Rinse your motorcycle thoroughly with cool water to remove loose dirt.
2. Fill a bucket with cool water. Mix in a mild, neutral detergent, such as dish washing liquid or a product made especially for washing motorcycles or automobiles.
3. Wash your motorcycle with a sponge or a soft towel. As you wash, check for heavy grime. If necessary, use a mild cleaner/degreaser to remove the grime.
4. Clean the windscreen with a soft cloth or sponge and plenty of water. Dry with a soft clean cloth. Remove minor

scratches with a commercially-available plastic polishing compound.

Take care to keep brake fluid or chemical solvents off the fairing. They will damage the plastic.

5. Clean the headlight, fairing, meter lens and other plastic parts using a cloth or sponge dampened with a solution of mild detergent and water. When cleaning the plastic headlight lens, use more care because it will scratch easier than a glass lens. Rub any soiled area, gently rinsing it frequently with fresh water.

(cont'd)



## Appearance Care

---

The taillight lens on your motorcycle is clear. The lens may become discolored if exhaust deposits or road contaminants accumulate on it. Exhaust deposits and road contaminants can be removed with a wet cloth and mild detergent.

6. After washing, rinse your motorcycle thoroughly with plenty of clean water to remove any residue. Detergent residue can corrode alloy parts.
7. Dry your motorcycle with a chamois or a soft towel. Leaving water on the surface to air dry can cause dulling and water spots. As you dry, inspect for chips and scratches.
8. Lubricate the drive chain to prevent rusting.
9. Start the engine and let it idle for several minutes. The engine heat will help dry moist areas.
10. As a precaution, ride your motorcycle at a slow speed and apply the brakes several times. This will help dry the brakes and restore normal braking performance.

### Spray Cleaning Your Motorcycle

Refer to *Safety Precautions* on page 76 .

Avoid using spray cleaner products on the tires or suspension components.

Suggestions for using spray cleaner(s) follow:

## Appearance Care

---

<b>Motorcycle Condition</b>	<b>Recommended Cleaning</b>
Dust and fingerprint smudges.	Apply a spray cleaner/polish and wipe the paint, chrome, glass, and clear plastic.
Light road grime.	Spray any difficult-to-reach or very dirty areas with a spray cleaner/degreaser. Rinse and dry. Apply a spray cleaner/polish and wipe with a non-abrasive cloth.
Heavy grime. Oil leaks. Brake dust.	Use a spray cleaner/degreaser. If necessary, rub with a sponge. Rinse and dry. Apply a spray cleaner/polish and wipe with a non-abrasive cloth.
Dull, corroded chrome or aluminum.	Apply a high quality chrome/aluminum polish and wipe with a non-abrasive cloth.

### Painted Aluminum Wheel Maintenance

Refer to *Safety Precautions* on page 76.

Aluminum may corrode from contact with dirt, mud, or road salt. Clean the wheels after riding through any of these substances. Use a wet sponge and mild detergent. Avoid stiff brushes, steel wool, or cleaners containing abrasives or chemical compounds.

After washing, rinse with plenty of water and dry with a clean cloth.

If the paint is chipped, apply touch-up paint.

### Clean the Matte Painted Surface

Refer to *Safety Precautions* on page 76.

Use a soft cloth or sponge, plenty of water, and a mild detergent to clean the matte paint. Dry with a soft, clean cloth.

Do not use polishing compounds or wax containing polishing compounds. These can damage or discolor the paint.

To keep your Honda looking new, clean and polish it frequently.

## Appearance Care

---

### Exhaust Pipe Maintenance

Refer to *Safety Precautions* on page 76 .

The exhaust pipe is stainless steel, but may become stained by oil or mud. If necessary, remove heat stains with a liquid kitchen abrasive.

### Finishing Touches

Refer to *Safety Precautions* on page 76 .

After washing your motorcycle, consider using a commercially-available spray cleaner/polish or quality liquid or paste wax to finish the job. Use only a non-abrasive polish or wax made specifically

for motorcycles or automobiles. Apply the polish or wax according to the instructions on the container.

If a surface on your motorcycle is chipped or scratched, your Honda dealer has touch-up paint to match your motorcycle's color. Be sure to use your motorcycle's color code (page 204 ) when you buy touch-up paint.

If the frame has a chip that exposes the metal, first apply primer (to prevent corrosion) and then apply the touch-up paint. Several thin layers of touch-up paint are better than one thick coat.

Here's a few helpful tips on how to store and transport your Honda, and how to be an environmentally responsible motorcycle owner.

Storing Your Honda .....	166
Transporting Your Motorcycle .....	169
You & the Environment .....	170

## Storing Your Honda

---

If you won't be riding for an extended period, such as during the winter, thoroughly inspect your motorcycle and correct any problem before storing it. That way, needed repairs won't be forgotten and it will be easier to get your motorcycle running again.

For more information about storage, refer to the *Honda Motorcycle Winter Storage Guide*, available from your Honda dealer (USA only).

We suggest you perform the following procedures to keep your motorcycle in top condition. These storage procedures will reduce the deterioration that can occur during storage.

### Preparation for Storage

Refer to *Safety Precautions* on page 76 .

1. Change the engine oil and filter (page 106 ).
2. Make sure the cooling system is filled with a 50/50% antifreeze solution (page 111 ).
3. Fill the fuel tank. Make sure the fuel fill cap is properly installed.

## Storing Your Honda

---

4. To prevent rusting in the cylinders, contact your Honda dealer.
5. Remove the battery and charge it fully. Store it in an area protected from freezing temperatures and direct sunlight. Slow charge the battery (page 155 ) once a month.
6. Wash and dry your motorcycle. Wax all painted surfaces (except matte painted surfaces). Apply rust-inhibiting oil to the chrome pieces.
7. Lubricate the drive chain (page 150 ).
8. Inflate the tires to their recommended pressures (page 137 ).
9. Store your motorcycle in an unheated area, free of dampness, away from sunlight, with a minimum of daily temperature variation.
10. Place your motorcycle on blocks to lift both tires off the floor.
11. Cover your motorcycle with a porous material. Avoid using plastic or similar non-breathing, coated materials that restrict air flow and allow heat and moisture to accumulate.



# Storing Your Honda

---

## Removal from Storage

Refer to *Safety Precautions* on page 76 .

1. Uncover and clean your motorcycle.
2. If your motorcycle has been stored for more than four months — change the engine oil (page 106).
3. If your motorcycle has been stored for more than two months — ask your Honda dealer to drain and replace the fuel.
4. Charge the battery (page 155 ) as required. Install the battery.
5. Lubricate the drive chain (page 150 ).
6. Perform a pre-ride inspection (page 49 ), then test-ride your motorcycle at low speeds.

## Transporting Your Motorcycle

---

If your motorcycle needs to be transported, it should be carried on a motorcycle trailer, or a truck or trailer with a flatbed area. For information about 24-hour emergency assistance, see page 231 (USA only). Do not tow your motorcycle, as towing can seriously damage the transmission.

When contacting a towing or transporting service, be sure to ask if they have a flatbed area, a loading ramp or power ramp to safely lift the motorcycle, and motorcycle tie-down straps.

## You & the Environment

---

Owning and riding a motorcycle can be enjoyable, but you must do your part to protect nature.

Following are tips on how you can be an environmentally-responsible motorcycle owner.

- **Choose Sensible Cleaners.** Use a biodegradable detergent when you wash your motorcycle. Avoid aerosol spray cleaners that contain chlorofluorocarbons (CFCs) which damage the atmosphere's protective ozone layer. Don't throw cleaning solvents away; see the following guidelines for proper disposal.

- **Recycle Wastes.** It's illegal and thoughtless to put used engine oil in the trash, down a drain, or on the ground. Used oil, gasoline, coolant, and cleaning solvents contain poisons that can hurt refuse workers and contaminate our drinking water, lakes, rivers, and oceans. Before changing your oil, make sure you have the proper containers. Put oil and other toxic wastes in separate sealed containers and take them to a recycling center. Call your local or state office of public works or environmental services to find a recycling center in your area, and to get instructions on how to dispose of non-recyclable wastes.

## Taking Care of the Unexpected

---

This section discusses the more common problems that can occur with your motorcycle while you're riding. It tells you how to evaluate each problem and what actions you can take to try to resume riding. If the problem cannot be safely solved, this section also gives instructions on the proper way to have your motorcycle transported.

For information about transporting your motorcycle, see page 169 .

General Guidelines .....	172
If Your Engine Quits or Won't Start .....	173
If You Have a Flat Tire .....	178
If Your Engine Overheats .....	191
If the Low Oil Pressure Indicator Lights .....	193
If a Fuse Blows.....	194
If You Crash .....	198
If You Lose Your Key .....	199
If Your Battery is Low (or Dead) .....	200

# Taking Care of the Unexpected

---

## General Guidelines

Keeping your motorcycle well-maintained is the best way to reduce the possibility of having a problem on the road. However, since problems can arise even with well-maintained machines, you may consider subscribing to an emergency roadside service plan. (USA only: For information about the Honda Rider's Club of America, see page 231.)

Remember to take along your owner's manual, the tool kit that came with your motorcycle, and any other items (such as tire repair supplies and additional tools) that might help you solve a problem on your own.

Should you ever have a problem while riding, please follow these guidelines:

- Always put personal safety first.
- Take time to assess the situation and your options before deciding what to do.
- If the problem is relatively minor and you have the tools, supplies, and skills to make a temporary repair, be sure to have permanent repairs made as soon as possible.
- Do not continue riding if you are hurt or your motorcycle is not in safe riding condition.

Additional recommendations for specific problems follow.

## If Your Engine Quits or Won't Start

---

Proper operation and maintenance can prevent starting and engine performance problems. In many cases, the cause of the problem may be a simple operational oversight.

If you have a problem starting the engine — or experience poor engine performance — the following information may help you. If you can't correct the problem, see your Honda dealer.

If your motorcycle won't start, listen as you press the start button. If you don't hear the starter motor turning, refer to the *Starter motor doesn't operate* symptom. If you can hear the starter motor working normally, refer to the *Starter motor works, but the engine won't start* symptom.

## If Your Engine Quits or Won't Start

---

SYMPTOM: <b>Starter motor doesn't operate.</b>	
POSSIBLE CAUSE	WHAT TO DO
ignition switch OFF	Turn the ignition switch ON.
transmission not in neutral	Shift into neutral.
side stand down (when transmission not in neutral)	Put the transmission in neutral or raise the side stand and pull the clutch lever in.
blown fuse	Replace with a new fuse of the same rating (page 194).
battery lead loose	Tighten the battery lead.
dead battery	Charge the battery (page 155). If charging doesn't help, see your Honda dealer.
faulty starter motor	If all possible causes are negative, the starter motor may be faulty. See your Honda dealer.

## If Your Engine Quits or Won't Start

---

SYMPTOM: <b>Starter motor works, but the engine won't start.</b>	
POSSIBLE CAUSE	WHAT TO DO
out of fuel	Fill the fuel tank.
flooded engine	See <i>Flooded Engine</i> (page 59 ).
loose or unconnected ignition coil connectors and ignition coils	See your Honda dealer.
loose battery cables	Tighten the battery terminal bolts.
weak battery	Charge the battery (page 155 ). If charging doesn't help, see your Honda dealer.



## **If Your Engine Quits or Won't Start**

<b>SYMPTOM: Engine starts, but stalls as you shift into gear.</b>	
<b>POSSIBLE CAUSE</b>	<b>WHAT TO DO</b>
side stand down	Raise the side stand. Start again.

<b>SYMPTOM: Engine starts, but runs poorly.</b>	
<b>POSSIBLE CAUSE</b>	<b>WHAT TO DO</b>
idles roughly, too fast, stalls	Check engine idle adjustment (page 120). If the problem persists, see your Honda dealer.
overheating	Check the coolant temperature meter. Refer to <i>If Your Engine Overheats</i> , page 191.
low oil pressure	Check the low oil pressure indicator. Refer to <i>If the Low Oil Pressure Indicator Lights</i> , page 193.
runs erratically, misfires	See your Honda dealer.
blubbers (rich fuel mixture)	See your Honda dealer.

## If Your Engine Quits or Won't Start

SYMPTOM: <b>Engine starts, but runs poorly. (cont'd)</b>	
POSSIBLE CAUSE	WHAT TO DO
sooty exhaust (rich fuel mixture)	See your Honda dealer.
detonates or pings under load	If applicable, switch to the recommended octane gasoline (page 97 ) or change your brand of gasoline. If the problem persists, see your Honda dealer.
afterfires (backfires)	See your Honda dealer.
pre-ignition (runs on after ignition switched OFF)	See your Honda dealer.

## If You Have a Flat Tire

---

A flat tire is always unwelcome, especially if you are far from help. If you think you are losing air, or you hit a pothole or hard object, pull safely to the side of the road so you can inspect the tires and assess the situation. (Be sure to park on a firm, level surface and use the side stand for support.) You should examine the tire treads and sidewalls for foreign objects or damage. If you find a tire that has been punctured or damaged, you have two options.

### Option 1:

#### Have Your Motorcycle Transported

If a tire has a major puncture or a cut in the tread or sidewall, or the bead has come loose from the rim, there is probably not much you can do except have your motorcycle transported to a Honda dealer

or other qualified service facility. (USA only: For information about 24-hour emergency roadside assistance, see page 231 .) Even with a simple puncture, this may be the safest and least troublesome solution. For transporting instructions, see page 169 .

### Option 2:

#### Make a Temporary Roadside Repair

If a tire has only a minor nail puncture and is not completely flat, you may be able to make an emergency repair that could allow you to continue riding to where you can get the tire replaced or permanently repaired.

## If You Have a Flat Tire

### **WARNING**

Riding your motorcycle with a temporary tire repair can be risky. If the temporary repair fails, you can crash and be seriously injured or killed.

If you must ride with a temporary tire repair, ride slowly and carefully and do not exceed 30 mph (50 km/h) until the tire is permanently repaired or replaced.

Due to the uncertainty of any temporary repair, you should ride slowly (not over 30 mph, 50 km/h) and carefully (preferably without a passenger or cargo) until the tire is replaced or permanently

repaired. Stop frequently and check the air pressure. If the tire is losing pressure, it may be unsafe to continue riding. As the tire gets low, it will affect the handling of your motorcycle (especially with a passenger and cargo) and it may overheat and blow out.

### **Types of Temporary Repairs**

The following types of temporary repairs generally require a source of air to inflate the tire. Possible sources include CO<sub>2</sub> cartridges or cans of compressed air designed to inflate a tire.

## If You Have a Flat Tire

---

- **Inflate the tire:** Tubeless tires have some self-sealing ability if they are punctured and the result is usually just a slow leak. If this is the case, you can try inflating the tire to see if it will hold air pressure. If you can see a nail or other object embedded in the tire tread, do not remove it at this time.
- **Plug the hole:** The idea here is to do something to temporarily stop the leak. If you have a tubeless tire repair kit, you can pull out the nail and try inserting an external plug in the puncture. Follow the instructions that came with the repair kit and be sure to inflate the tire to the correct pressure.

### Should You Repair or Replace a Tire?

We strongly recommend that you replace, not permanently repair, any tire that is punctured or damaged, even if the tire has only a minor puncture. For a full discussion of repairs and replacement, see page 140.

## If You Have a Flat Tire

### Emergency Front Wheel Removal/Installation

Refer to *Safety Precautions* on page 76 .

We recommend wheel removal be done only by your Honda dealer or another qualified mechanic. Do not attempt to remove the wheel on your own. Wheel removal requires mechanical skill and professional tools.

RIGHT SIDE

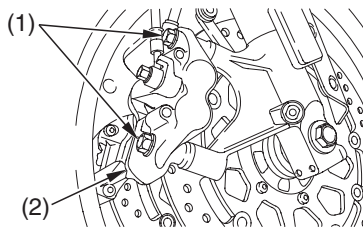

- (1) fixing bolts
- (2) brake caliper assembly

#### Removal

1. Park your motorcycle on a firm, level surface.

(cont'd)

## If You Have a Flat Tire

---

2. Raise the front wheel off the ground by placing a support block under the engine.
3. Remove the fixing bolts ( 1 ) and remove the right and left caliper assemblies ( 2 ) from the fork legs.
  - To avoid damage to the brake hose during removal, support the caliper assembly so that it doesn't hang from the hose. Do not twist the brake hose.
  - Avoid getting grease, oil, or dirt on the disc or pad surfaces. Any contamination can cause poor brake performance or rapid pad wear after reassembly.

4. Remove the axle bolt ( 3 ), and then loosen the right and left axle pinch bolts ( 4 ).

### RIGHT FRONT

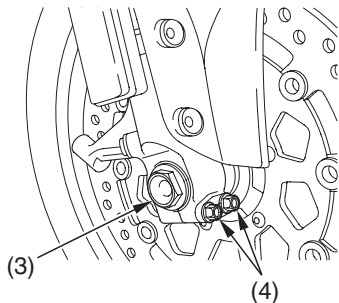

- (3) axle bolt  
(4) axle pinch bolts

## If You Have a Flat Tire

- Remove the front axle shaft (5) and the wheel.
  - Avoid depressing the brake lever when the wheel is off the motorcycle. This will force the caliper pistons out of the cylinders. The result will be loss of brake fluid. If this occurs, the brake system will require service. See your Honda dealer for this service.

### LEFT FRONT

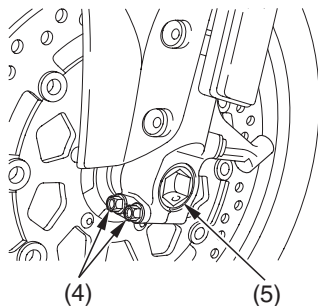

(5) front axle shaft

### Installation

- Position the wheel between the fork legs and insert the front axle shaft from the left side, through the left fork leg and wheel hub.

(cont'd)



## If You Have a Flat Tire

---

2. Align the end of axle shaft ( 1 ) with the surface of fork leg ( 2 ).
3. Tighten the front axle bolt to the specified torque:  
**58 lbf·ft (79 N·m , 8.0 kgf·m)**
4. Tighten the axle pinch bolts on the right fork leg to the specified torque:  
**16 lbf·ft (22 N·m , 2.2 kgf·m)**

LEFT FRONT

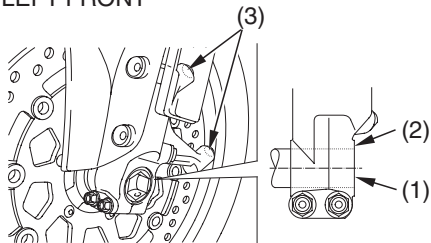

(1) end of axle shaft  
(2) surface of fork leg

(3) front fork  
spacers

5. Temporarily tighten the axle pinch bolts on the left fork leg until lightly seated.
6. Fit the brake disc carefully between the brake pads to avoid damaging the pads.
7. Make sure that the front fork spacers ( 3 ) are installed into the caliper bracket properly.
8. Install the caliper fixing bolts and tighten to the specified torque:  
**33 lbf·ft (45 N·m , 4.6 kgf·m)**
9. Operate the front brake and pump the fork several times. Check for free wheel rotation after the brake is released. Recheck the wheel if the brake drags or the wheel does not rotate freely.

## If You Have a Flat Tire

10. Measure the clearance (4) between the brake disc (5) and the caliper body (6) on each side with a 0.028 in (0.7 mm) feeler gauge (7).

- If the feeler gauge inserts easily, remove it and tighten the left axle pinch bolts to the specified torque:  
**16 lbf·ft (22 N·m , 2.2 kgf·m)**
- If the feeler gauge cannot be inserted easily, loosen the left axle pinch bolts and pull the left fork outward or push inward to adjust the clearance. Then tighten the axle pinch bolts to the specified torque.

Failure to provide adequate disc-to-caliper body clearance may damage the brake discs and impair braking efficiency.

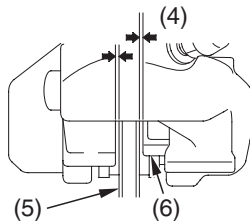

(4) clearance  
(5) brake disc

(6) caliper body

LEFT FRONT

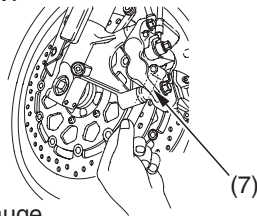

(7) feeler gauge

(cont'd)

## If You Have a Flat Tire

---

11. After installing the wheel, apply the brakes several times, then recheck both discs for caliper body to disc clearance. Do not operate the motorcycle without adequate clearance.

If a torque wrench was not used for installation, see your Honda dealer as soon as possible to verify proper assembly. Improper assembly may lead to loss of braking capability.

## If You Have a Flat Tire

### Emergency Rear Wheel Removal/Installation

Refer to *Safety Precautions* on page 76.

We recommend wheel removal be done only by your Honda dealer or another qualified mechanic. Do not attempt to remove the wheel on your own. Wheel removal requires mechanical skill and professional tools.

#### Removal

1. Park your motorcycle on a firm, level surface.
2. Raise the rear wheel off the ground by placing a support block under the engine.

3. Loosen the rear axle nut (1).
4. Loosen the drive chain adjuster lock nuts (2) and turn the drive chain adjusting bolts (3) so the rear wheel can be moved all the way forward for maximum drive chain slack.

#### RIGHT REAR

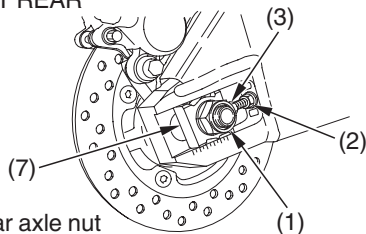

- (1) rear axle nut
- (2) drive chain lock nut
- (3) drive chain adjusting bolt
- (7) right chain adjustment plate

5. Remove the rear axle nut (1) and washer. (cont'd)

## If You Have a Flat Tire

---

6. Remove the drive chain ( 4 ) from the rear sprocket by pushing the rear wheel forward.

### LEFT REAR

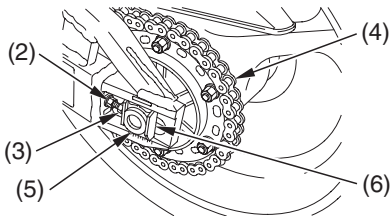

- (4) drive chain
- (5) rear axle shaft
- (6) left chain adjustment plate

7. Remove the rear axle shaft ( 5 ), rear wheel, left chain adjustment plate ( 6 ), right chain adjustment plate ( 7 ), rear brake bracket and side collars from the swingarm.

- To avoid damage to the brake hose during removal, support the caliper assembly so that it doesn't hang from the hose. Do not twist the brake hose.
- Avoid depressing the brake pedal when the wheel is off the motorcycle. This will force the caliper pistons out of the cylinders. The result will be a loss of brake fluid. If this occurs, the brake system will require service. See your Honda dealer for this service.

## If You Have a Flat Tire

### Installation

1. Install the side collars and position the wheel and rear brake bracket.
  - While installing the wheel, carefully fit the brake disc between the brake pads to avoid damaging the pads.
  - Avoid getting grease, oil, or dirt on the disc or pad surfaces. Any contamination can cause poor brake performance or rapid pad wear after reassembly.

2. Make sure that the lug (8) on the rear brake bracket is located in the slot (9) on the swingarm (10).

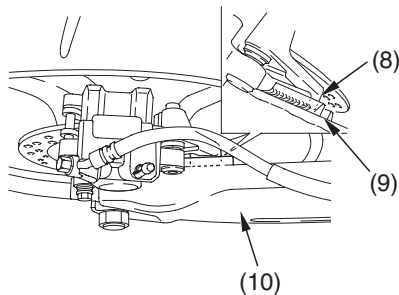

(8) lug  
(9) slot

(10) swingarm

(cont'd)

## If You Have a Flat Tire

---

3. Insert the rear axle shaft from the left side, through the left swingarm, wheel hub and rear brake bracket.
4. Install the drive chain by pushing the rear wheel forward.
5. Install the rear axle nut and tighten the drive chain adjusting bolts.  
Refer to drive chain adjustment (page 148 ).
6. Tighten the rear axle nut to the specified torque:  
**83 lbf·ft (113 N·m , 11.5 kgf·m)**  
Failure to provide adequate disc-to-rear brake bracket clearance may damage the brake discs and impair braking efficiency.

7. After installing the wheel, apply the brakes several times, then recheck both discs for caliper holder to disc clearance. Do not operate the motorcycle without adequate clearance.

If a torque wrench was not used for installation, see your Honda dealer as soon as possible to verify proper assembly. Improper assembly may lead to loss of braking capability.

## If Your Engine Overheats

---

Normally, the coolant temperature on your temperature meter will rise and then level off. Hot weather may cause the temperature to rise higher than normal. So will temporary stress such as climbing a hill. If you're stuck in stop-and-go traffic, the temperature may climb some, but the radiator fan is designed to prevent overheating. Be aware of these variations as you monitor the meter.

If the coolant temperature display begins to flash, and the coolant temperature indicator/malfunction indicator lamp (MIL) go on for no apparent reason, pull safely to the side of the road. If possible, park in a shady area.

### NOTICE

*Continuing to ride with an overheated engine can cause serious engine damage.*

- A steaming engine indicates a coolant leak. Shut the engine off and wait until the steaming stops. Look for a leak, but don't touch the engine or radiator system. Let everything cool off first.
- If there's no obvious problem, leave the engine on so the fan and coolant circulating system can continue working. Monitor the temperature meter. The temperature may drop to the normal range after a brief stop with no load on the engine.

(cont'd)



## If Your Engine Overheats

---

- Check the radiator fan.  
If the fan is not working, turn the engine off. Open the fuse box (page 194 ) and check the radiator fan fuse. If the fuse is blown, replace it with the proper (same rating) spare fuse. Start the engine. If the malfunction indicator lamp (MIL) and the coolant temperature indicator go on, turn the engine off. If the radiator fan is working, visually check the coolant level in the reserve tank, located behind the right middle cowl (page 112 ). It isn't necessary to touch the radiator system.
- If the reserve tank is low or empty, don't ride without adding coolant (page 112 ). After adding coolant, turn the engine on and check the temperature meter. If the temperature doesn't drop, do not ride. The engine needs repair. Transport

your motorcycle to a Honda dealer (page 169 ).

If the temperature drops to normal, check the coolant level. If it has gone down, add more coolant.

If you are able to resume riding, continue to monitor the meter frequently.

If there's a mild leak, you can ride for awhile, carefully watching the meter. Be prepared to stop and add more coolant or water. If the leak is bad, transport your motorcycle to a Honda dealer (page 169 ).

## If the Low Oil Pressure Indicator Lights

---

If you check your engine oil level regularly, you should never see the low oil pressure indicator and the malfunction indicator lamp (MIL) go on while riding. Normally, both will only light momentarily when you turn the ignition switch ON. Occasionally, it may flicker at or near idling speed.

Low oil pressure may be caused by an oil leak, a low oil level, or some problem in the engine's lubrication system.

If the malfunction indicator lamp (MIL) and the low oil pressure indicator light while you're riding, don't ignore them. Pull safely to the side of the road. If possible, pull the clutch lever in and coast to a stop. Stop the engine as soon as it's safe to do so.

### NOTICE

*Continuing to ride with low oil pressure can cause serious engine damage.*

- Check for an oil leak.
- Then check the oil level. If necessary, add the recommended oil (page 102 ) to the upper level mark. If you must leave your motorcycle to get oil, secure it as much as possible.
- After adding oil, start the engine, and check that the low oil pressure indicator and malfunction indicator lamp (MIL) go off. Check for a possible leak.

If the indicators go off and there is no leak — resume riding. If there is a leak — do not ride the motorcycle until the leak is repaired by a Honda dealer.

## If a Fuse Blows

---

All of the electrical circuits on your motorcycle have fuses to protect them from damage caused by excess current flow (short circuit or overload).

If something electrical on your motorcycle stops working, the first thing you should check for is a blown fuse.

Determine from the chart on the circuit fuse box cover which fuse or fuses control that component. Check those fuses first, but check all the fuses before looking elsewhere for another possible cause of the problem. Replace any blown fuses and check component operation.

- Main fuse (and spare) are located on the starter motor magnetic switch (3) under the front seat.
- FI fuse is located under the front seat.
- The circuit fuse box (including spare fuses) is located behind the left middle cowl.

### Recommended Fuses

main fuse	30A
FI fuse	20A
other fuses	10A, 20A

1. To prevent an accidental short circuit, turn the ignition switch OFF before checking or replacing the fuses.
2. Remove the front seat (page 92).

## If a Fuse Blows

### UNDER FRONT SEAT

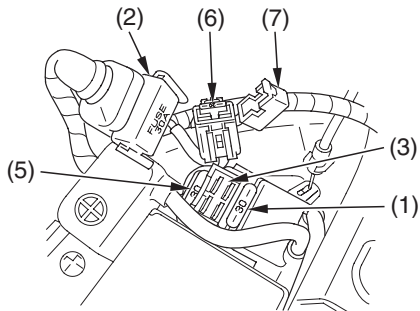

- (1) main fuse
- (2) wire connector
- (3) starter motor magnetic switch
- (5) spare main fuse
- (6) FI fuse
- (7) FI fuse cover

### Main Fuse Access:

3. To access the main fuse (1), disconnect the wire connector (2) of the starter motor magnetic switch (3).
4. Pull the main fuse out. If it is blown (4), install the spare main fuse (5).

### MAIN FUSE

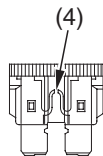

- (4) blown fuse

5. Reconnect the wire connector.

(cont'd)

## If a Fuse Blows

### *FI Fuse Access:*

6. To access FI fuse (6), open the FI fuse cover (7).

7. Pull FI fuse out.

If it is blown (8), install spare FI fuse (12).

The spare fuse is located in the fuse box.

FI FUSE

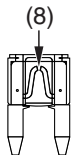

(8) blown fuse

8. Close the FI fuse cover.

9. Install the front seat.

### *Circuit Fuse Access:*

10. Remove the left middle cowl (page 94 ).

11. Open the rubber cover ( 9 ) and fuse box cover ( 10 ).

BEHIND LEFT MIDDLE COWL

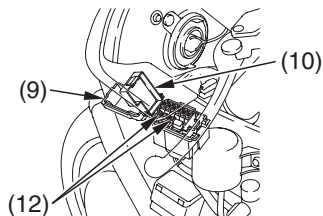

(9) rubber cover      (12) spare fuses  
(10) fuse box cover

12. To check or replace a circuit fuse, pull the old fuse out of its retaining clips. Look for a burned wire inside the fuse. If the fuse is blown ( 11 ), replace it with a spare fuse ( 12 ) of the same rating or lower.

## If a Fuse Blows

### CIRCUIT FUSE

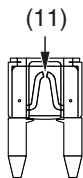

(11) blown fuse

13. Close the fuse box cover and rubber cover.
14. Install the left middle cowl.

If you do not have a replacement fuse with the proper rating for the circuit, install one with a lower rating.

#### NOTICE

*Replacing a fuse with one that has a higher rating greatly increases the chance of damage to the electrical system.*

If you do not have a spare fuse and you cannot ride the motorcycle without fixing the problem, take a fuse of the same rating or a lower rating from one of the other circuits that you can do without temporarily.

If you replace a blown fuse with a spare fuse that has a lower rating, replace the fuse with the correct rating as soon as you can. Also remember to replace any spare fuses that were installed.

If the replacement fuse of the same rating burns out in a short time, there is probably a serious electrical problem on your motorcycle. Leave the blown fuse in that circuit and have your motorcycle checked by your Honda dealer.

## If You Crash

---

Personal safety is your first priority after any accident. If you or anyone else has been injured, take time to assess the severity of the injuries and whether it is safe to continue riding. Call for emergency assistance if needed. Also follow applicable laws and regulations if another person or vehicle is involved in the accident.

If you decide you are capable of riding safely, carefully inspect your motorcycle for damage and determine if it is safe to ride. Check the tightness of critical nuts and bolts securing such parts as the handlebar, control levers, brakes, and wheels.

If there is minor damage, or you are unsure about possible damage, ride slowly and cautiously. Sometimes, crash damage is hidden or not immediately apparent, so you should have your motorcycle thoroughly checked at a qualified service facility as soon as possible. Also, be sure to have your Honda dealer check the frame and suspension after any serious crash.

If your motorcycle cannot be ridden, see *Transporting Your Motorcycle*, page 169.

## If You Lose Your Key

You should receive a key number plate (1) with your keys. Store this plate in a safe place.

Be sure to record your key number in the Quick Reference section at the rear of the manual. You'll need this number to have a duplicate key made.

A lost key won't be a problem if you take preventative action. Store one duplicate key in a safe place at home and carry a second duplicate in your wallet.

If you lose your key and aren't carrying a duplicate, either get your spare or have one made. If you don't know your key number, call the dealer you purchased your Honda from. They may have it listed in their records. If they don't, transport

your motorcycle to them or the nearest Honda dealer. The dealer will probably have to remove the ignition switch assembly to find the key number so they can make a key for you.

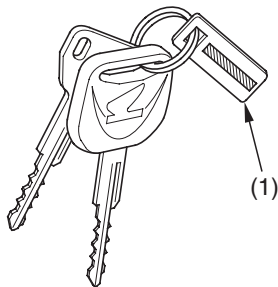

(1) key number plate



## **If Your Battery is Low (or Dead)**

---

Jump starting is not recommended, especially if you use an automobile battery. The greater amperage of an automobile battery when the car engine is running can damage your motorcycle's electrical system.

Bump starting is also not recommended.

If you can't charge the battery or it appears unable to hold a charge, contact your Honda dealer.

## Technical Information

---

This section contains dimensions, capacities, and other technical data, plus information on government requirements and how to break-in your motorcycle.

Vehicle Identification.....	202
Specifications .....	205
Break-in Guidelines.....	212
Emission Control Systems .....	213
Catalytic Converter (California only).....	219
Oxygenated Fuels .....	220

# Vehicle Identification

---

## Serial Numbers

The frame, VIN, and engine serial numbers are required when you register your motorcycle. They may also be required when ordering replacement parts. You may record these numbers in the Quick Reference section at the rear of this manual.

The VIN (vehicle identification number) appears on the Safety Certification Label attached to the left side of the frame.

### LEFT SIDE

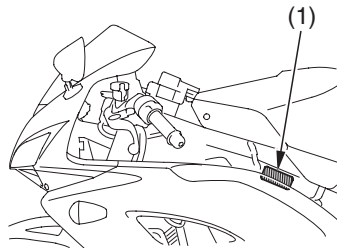

(1) VIN

## Vehicle Identification

The frame number (2) is stamped on the right side of the steering head.

RIGHT SIDE

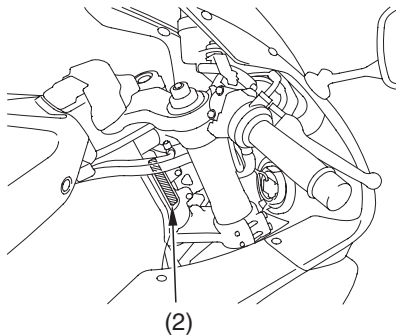

(2) frame number

The engine number (3) is stamped on the rear of the crankcase.

LEFT SIDE

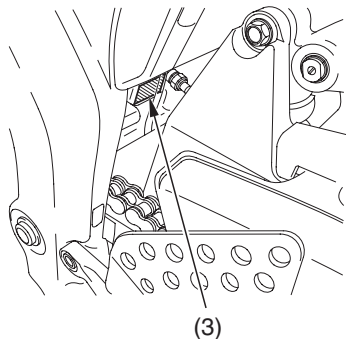

(3) engine number

## Vehicle Identification

---

### Color Label & Code

The color label is attached on the rear fender under the rear seat. Remove the rear seat (page 93 ) to check the label.

The color code is helpful when ordering replacement parts. You may record the color and code in the Quick Reference section at the rear of this manual.

### UNDER REAR SEAT

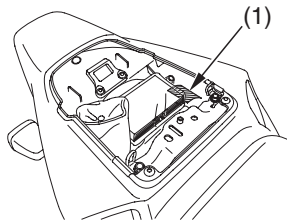

(1) color label

## Specifications

<b>Dimensions</b>	
overall length	80.1 in (2,035 mm)
overall width	28.3 in (720 mm)
overall height	44.1 in (1,120 mm)
wheelbase	55.3 in (1,405 mm)
ground clearance	5.1 in (130 mm)

<b>Weight</b>	
dry weight	397 lbs (180 kg) 399 lbs (181 kg) California only

## Specifications

---

<b>Fuel &amp; Lubricants</b>	
fuel recommendation	premium unleaded gasoline, pump octane number of 91 or higher
fuel tank capacity	4.76 US gal (18.0 ℓ)
engine oil capacity	after disassembly: 4.0 US qt (3.8 ℓ) after draining: 3.2 US qt (3.0 ℓ) after draining & oil filter change: 3.3 US qt (3.1 ℓ)
engine oil recommendation	API Service Classification SG or higher except oils labeled as energy conserving on the circular API service label, SAE 10W-40, JASO T 903 standard MA, Pro Honda GN4 or HP4 (without molybdenum additives) 4-stroke oil (USA & Canada) or Honda 4-stroke oil (Canada only), or an equivalent motorcycle oil
drive chain lubricant	SAE 80 or 90 gear oil
cooling system, recommendation	Pro Honda HP Coolant or an equivalent high quality ethylene glycol antifreeze containing corrosion protection inhibitors specifically recommended for use in aluminum engines
cooling system, capacity	3.7 US qt (3.5 ℓ)

## Specifications

<b>Capacities</b>	
passenger capacity	operator, one passenger
maximum weight capacity	USA : 366 lbs (166 kg) Canada : 375 lbs (170 kg) rider, passenger, all cargo and accessories

<b>Engine Specifications</b>	
displacement	60.9 cu-in (998 cm <sup>3</sup> )
bore & stroke	2.95 × 2.22 in (75.0 × 56.5 mm)
compression ratio	11.9 : 1
spark plug (standard)	IMR9C-9HES (NGK) VUH27ES (DENSO)
valve clearance (cold)	intake 0.006 in (0.16 mm) exhaust 0.012 in (0.30 mm)
idle speed	1,200 ± 100 rpm



## Specifications

---

<b>Power Transmission</b>	
primary reduction	1.604
gear ratio, 1st	2.538
2nd	1.941
3rd	1.578
4th	1.380
5th	1.250
6th	1.160
final reduction	2.562
standard sprocket sizes	drive (engine) sprocket: 16 teeth driven (rear wheel) sprocket: 41 teeth
final drive	chain DID 50VM2 or RK 50GFOZ1

## Specifications

<b>Chassis &amp; Suspension</b>	
caster	23°45'
trail	4.0 in (102 mm)
tire size, front	120/70ZR17M/C (58W)
tire size, rear	190/50ZR17M/C (73W)
tire type	radial, tubeless
tire pressure, front (cold)	36 psi (250 kPa , 2.50 kgf/cm <sup>2</sup> )
tire pressure, rear (cold)	42 psi (290 kPa , 2.90 kgf/cm <sup>2</sup> )

<b>Electrical</b>	
battery	12V-8.6 Ah
generator	0.344 kW/5,000 rpm

## Specifications

---

<b>Lights</b>	
headlight	12V-55W (2 bulbs)
brake/tail light	LED
turn signal lights	12V-32/3CP (front) 12V-21W (rear)
license light	12V-5W
position light	12V-5W

<b>Fuses</b>	
main	30A
FI	20A
other fuses	10A, 20A

## Specifications

<b>Torque Specifications</b>	
oil drain bolt	22 lbf·ft (30 N·m , 3.0 kgf·m)
oil filter	20 lbf·ft (26 N·m , 2.7 kgf·m)
front wheel axle bolt	58 lbf·ft (79 N·m , 8.0 kgf·m)
front wheel caliper fixing bolts	33 lbf·ft (45 N·m , 4.6 kgf·m)
front wheel axle pinch bolts	16 lbf·ft (22 N·m , 2.2 kgf·m)
rear wheel axle nut	83 lbf·ft (113 N·m , 11.5 kgf·m)

## Break-in Guidelines

---

Help assure your motorcycle's future reliability and performance by paying extra attention to how you ride during the first 300 miles (500 km).

During this period, avoid full-throttle starts and rapid acceleration.

## Emission Control Systems

### Exhaust Emission Requirements

The U.S. Environmental Protection Agency (EPA), the California Air Resources Board (CARB), and Environment Canada require that your motorcycle comply with applicable exhaust emissions standards during its useful life, when operated and maintained according to the instructions provided.

### Noise Emission Requirements

The EPA also requires that motorcycles built after January 1, 1983 comply with applicable noise emission standards for one year or 3,730 miles (6,000 km) after the time of sale to the ultimate purchaser, when operated and maintained according to the instructions provided. (USA only)

### Warranty Compliance

Compliance with the terms of the Distributor's Warranties for Honda Motorcycle Emission Control Systems is necessary in order to keep the emissions system warranty in effect. (USA only)

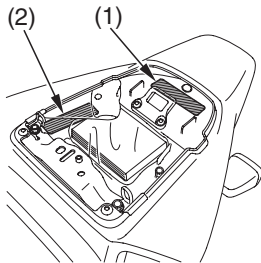

- (1) vehicle emission control information label
- (2) vehicle emission control information label (Canada only)

# Emission Control Systems

---

The Vehicle Emission Control Information label (1) (2) is attached on the rear fender under the rear seat.

## Source of Exhaust Emissions

The combustion process produces carbon monoxide (CO), oxides of nitrogen (NOx) and hydrocarbons (HC). Control of hydrocarbons and oxides of nitrogen is very important because, under certain conditions, they react to form photochemical smog when subjected to sunlight. Carbon monoxide does not react in the same way, but it is toxic.

Honda Motor Co., Ltd. utilizes various systems to reduce carbon monoxide, oxides of nitrogen and hydrocarbons.

## Emission Control Systems

---

### **Exhaust Emission Control System**

The exhaust emission control system includes a secondary air supply system, and a PGM-FI system. (California only: also includes an oxidation catalytic converter.)

No adjustment to these systems should be made although periodic inspection of the components is recommended.

### ***PGM-FI System***

The PGM-FI system uses dual sequential fuel injection. It has four subsystems: Air Intake, Engine Control, Fuel Control, and Exhaust Control.

The Engine Control Module (ECM) uses various sensors to determine how much air is going into the engine. It then controls how much fuel to inject under all operating conditions.

### ***Ignition Timing Control System***

The system constantly adjusts the ignition timing, reducing the amount of HC, CO and NOx produced.



# Emission Control Systems

---

## ***Secondary Air Injection System***

The secondary air injection system introduces filtered air into the exhaust gases in the exhaust port. The secondary air injection system helps improve emission performance.

## ***Oxidation Catalytic Converter (California only)***

The oxidation catalytic converter is in the exhaust system. Through chemical reactions, they convert HC and CO in the engine's exhaust to carbon dioxide (CO<sub>2</sub>) and water vapor.

## **Evaporative Emission Control System (California only)**

This motorcycle complies with the requirements of the California Air Resources Board (CARB) evaporative emission regulations. Fuel vapor from the fuel tank is directed into the charcoal canister and air cleaner where it is adsorbed and stored while the engine is stopped. When the engine is running and the purge control solenoid valve is open, fuel vapor in the charcoal canister and air cleaner is drawn into the engine through the throttle body.

## Emission Control Systems

---

### **Crankcase Emission Control System**

The engine is equipped with a closed crankcase system to prevent discharging crankcase emissions into the atmosphere. Blow-by gas is returned to the combustion chamber through the air cleaner and the intake manifold.

### **Problems That May Affect Motorcycle Exhaust Emissions**

If you are aware of any of the following symptoms, have the vehicle inspected and repaired by your authorized Honda motorcycle dealer.

Symptoms:

1. Hard starting or stalling after starting
2. Rough idle
3. Misfiring or backfiring during acceleration
4. After-burning (backfiring)
5. Poor performance (driveability) and poor fuel economy

# Emission Control Systems

---

## Noise Emission Control System TAMPERING WITH THE NOISE CONTROL SYSTEM IS PROHIBITED:

U. S. federal law prohibits, or Canadian provincial laws may prohibit the following acts or the causing thereof: ( 1 ) The removal or rendering inoperative by any person, other than for purposes of maintenance, repair or replacement, of any device or element of design incorporated into any new vehicle for the purpose of noise control prior to its sale or delivery to the ultimate purchaser or while it is in use; or ( 2 ) the use of the vehicle after such device or element of design has been removed or rendered inoperative by any person.

## AMONG THOSE ACTS PRESUMED TO CONSTITUTE TAMPERING ARE THE FOLLOWING ACTS:

1. Removal of, or puncturing the muffler, baffles, header pipes or any other component which conducts exhaust gases.
2. Removal of, or puncturing of any part of the intake system.
3. Lack of proper maintenance.
4. Replacing any moving parts of the vehicle, or parts of the exhaust or intake system, with parts other than those specified by the manufacturer.

## Catalytic Converter (California Only)

---

This motorcycle is equipped with an oxidation catalytic converter.

The catalytic converter contains precious metals that serve as catalysts, promoting chemical reactions to convert the exhaust gasses without affecting the metals.

The catalytic converter acts on HC and CO. A replacement unit must be an original Honda part or its equivalent.

The catalytic converter must operate at a high temperature for the chemical reactions to take place. It can set fire to any combustible materials that come near it. Park your motorcycle away from high grasses, dry leaves, or other flammables.

A defective catalytic converter contributes to air pollution, and can impair your engine's performance. Follow these guidelines to protect your motorcycle's catalytic converter.

- Always use unleaded gasoline. Even a small amount of leaded gasoline can contaminate the catalyst metals, making the catalytic converter ineffective.
- Keep the engine tuned-up.
- Have your motorcycle diagnosed and repaired if it is misfiring, backfiring, stalling or otherwise not running properly.

## Oxygenated Fuels

---

Some conventional gasolines are being blended with alcohol or an ether compound. These gasolines are collectively referred to as oxygenated fuels. To meet clean air standards, some areas of the United States and Canada use oxygenated fuels to help reduce emissions. If you use an oxygenated fuel, be sure it is unleaded and meets the minimum octane rating requirement.

Before using an oxygenated fuel, try to confirm the fuel's contents. Some states/provinces require this information to be posted on the pump.

The following are the EPA-approved percentages of oxygenates:

ETHANOL (ethyl or grain alcohol) 10%  
by Volume

You may use gasoline containing up to 10% ethanol by volume. Gasoline containing ethanol may be marketed under the name "Gasohol".

MTBE (Methyl Tertiary Butyl Ether) 15%  
by Volume

You may use gasoline containing up to 15% MTBE by volume.

## Oxygenated Fuels

---

### METHANOL (methyl or wood alcohol) 5% by Volume

You may use gasoline containing methanol containing up to 5% methanol by volume as long as it also contains cosolvents and corrosion inhibitors to protect the fuel system. Gasoline containing more than 5% methanol by volume may cause starting and/or performance problems. It may also damage metal, rubber, and plastic parts of your fuel system.

If you notice any undesirable operating symptoms, try another service station or switch to another brand of gasoline.

Fuel system damage or performance problems resulting from the use of an oxygenated fuel containing more than the percentages of oxygenates mentioned above are not covered under warranty.

Oxygenated fuels can damage paint and plastic. Be careful not to spill fuel when filling the fuel tank. Wipe up any spills immediately.

#### NOTICE

*Oxygenated fuels can damage paint and plastic. Damage caused by spilled fuel is not covered by warranty.*



## Consumer Information

---

This section contains information on your warranty and how to get an official Honda service manual.

Authorized Manuals .....	224
Warranty Coverage .....	227
Warranty Service .....	228
Contacting Honda.....	229
Your Honda Dealer .....	230
The Honda Rider's Club (USA only) .....	231
Reporting Safety Defects (USA only) .....	232



## Authorized Manuals

---

The Service Manual used by your authorized Honda dealer is available from Helm, Inc. (USA only, Canada: See your Honda dealer to order authorized manuals.)

Also available, but not necessary, to service your model is the Honda Common Service Manual which explains theory of operation and basic service information for various systems common to all Honda motorcycles, motor scooters and ATVs.

These Honda manuals are written for the professional technician, but most mechanically-capable owners should find them easy to use if they have the proper tools and observe proper safety standards. Special Honda tools are necessary for some procedures.

Publication Item No.	Description	Price Each*
61MEL01	2005 CBR1000RR Service Manual	\$60.00
61CM002	Common Service Manual	\$48.00
31MEL610	2005 CBR1000RR Owner's Manual	\$16.00
<i>* Prices are subject to change without notice and without incurring obligation.</i>		

**Order On-Line: [www.helminc.com](http://www.helminc.com)**

**Order Toll Free: 1-888-CYCLE93 (1-888-292-5393)**

*(NOTE: For Credit Card Orders Only)*

**Monday — Friday 8:00 AM — 6:00 PM EST**

**OR**

By completing this form you can order the materials desired. You can pay by check or money order, or charge to your credit card. Mail to Helm, Inc. at the address shown on the back of this order form (USA only).

Canada: See your Honda dealer to order authorized manuals.

<b>Publication Item No.</b>	<b>Item Description</b>	<b>Qty.</b>	<b>Price Each*</b>	<b>Total Price</b>
*Prices are subject to change without notice and without incurring obligation.  Orders are mailed within 10 days. Please allow adequate time for delivery.		<b>Sub Total</b>		
		<b>Purchaser's Sales Tax</b>		
		<b>Mich. Add 6 %</b>		
		<b>Calif. Add 8.25 %</b>		
		<b>Handling Charge</b>		<b>\$5.00</b>
		<b>Grand Total</b>		

**S  
H  
I  
P  
T  
O**

NOTE: Dealers and Companies please provide dealer or company name, and also the name of the person to whose attention the shipment should be sent.

Customer Name \_\_\_\_\_ Attention \_\_\_\_\_

Street Address - No P. O. Box Number \_\_\_\_\_ Apartment Number \_\_\_\_\_

City \_\_\_\_\_ State \_\_\_\_\_ Zip Code \_\_\_\_\_

Daytime Telephone Number (      ) \_\_\_\_\_

**P  
A  
Y  
M  
E  
N  
T**

Check or money order enclosed payable to Helm Inc.  
U.S. funds only. Do not send cash.

Check here if your billing address is different from the  
shipping address shown above.

MasterCard

Account Number

Expiration: Mo. Yr.

VISA

Discover

Customer Signature \_\_\_\_\_ Date \_\_\_\_\_

These Publications cannot be returned for credit without receiving advance authorization within 14 days of delivery. On returns, a restocking fee may be applied against the original order.

**HELM** P.O. BOX 07280, DETROIT, MICHIGAN 48207

## Warranty Coverage

---

Your new Honda is covered by these warranties:

- Motorcycle Limited Warranty
- Exhaust Emission Warranty
- Noise Control Warranty

There are responsibilities, restrictions, and exclusions which apply to these warranties. Please read the Warranties Booklet given to you by your Honda dealer at the time of purchase. Be sure to keep your Honda owner's card with your Warranties Booklet (USA only).

It is important to realize that your warranty applies to defects in material or workmanship of your Honda. Your warranty coverage does not apply to normal wear or deterioration associated with using the motorcycle.

Your warranty coverage will not be voided if you choose to perform your own maintenance. However, you should have the proper tools and service information and be mechanically qualified. Failures that occur due directly to improper maintenance are not covered.

Almost all of your warranty coverage can be extended through the Honda Protection Plan (USA only). For more information, see your Honda dealer.

## Warranty Service

---

Please remember that recommended maintenance interval servicing is not included in your warranty coverage. Additionally, your warranty does not apply to the normal wear of items (such as brakes, tires, etc.).

If you believe you have a problem with your motorcycle, call the service department of your Honda dealer. Make an appointment for an inspection and diagnosis. Remember, as the owner of the motorcycle, you will be asked to authorize that inspection. Your dealer will give you the results of the inspection. If the problem is covered under warranty, your dealer will perform the warranty repairs for you.

If you have questions about warranty coverage or the nature of the repair, it is best to talk to the service manager of your Honda dealer.

Sometimes, in spite of the best intentions of all concerned, a misunderstanding may occur. If you aren't satisfied with your dealer's handling of the situation, we suggest you discuss your problem with the appropriate member of the dealership's management team. If the problem has already been reviewed with the Service Manager, Parts Manager, Sales Manager, etc., contact the Owner of the dealership or their designated representative.

## Contacting Honda

---

Your owner's manual was written to cover most of the questions you might ask about your Honda. Any questions not answered in the owner's manual can be answered by your Honda dealer. If your dealer doesn't have the answer right away, they will get it for you.

If you have a difference of opinion with your dealer, please remember that each dealership is independently owned and operated. That's why it's important to work to resolve any differences at the dealership level.

If you wish to comment on your experiences with your Honda or with your dealer, please send your comments to the following address (USA only):

Motorcycle Division, American Honda Motor Co., Inc., P.O. Box 2220, Torrance, CA 90509-2220, mailstop: 100-4W-5B, telephone: (310) 532-9811.

Canada: Refer to the Warranties Booklet that was supplied with your vehicle.

Please include the following information in your letter:

- name, address, and telephone number
- product model, year, and frame/VIN serial number
- date of purchase
- dealer name and address

We will likely ask your Honda dealer to respond, or possibly acknowledge your comments directly.

## Your Honda Dealer

---

Once you purchase your new Honda, get familiar with the organization of your Honda dealer so you can utilize the full range of services available.

The service department is there to perform regular maintenance and unexpected repairs. It has the latest available service information from Honda. The service department will also handle warranty inspections and repairs.

The parts department offers Genuine Honda parts, Pro Honda products, Hondaline accessories (USA only), and Honda accessories and products (Canada only). The same quality that went into your Honda can be found in Genuine Honda replacement parts. You'll also find comparable quality in the accessories and

products available from the parts department.

The sales department offers the Honda Protection Plan to extend almost all of your warranty coverage (USA only). Your Honda dealer can inform you about competition and other riding events in your area. You'll also find that your dealer is a source of information about American Honda's Rider Education Centers and the Honda Rider's Club of America (USA only).

We're sure you'll be as pleased with the service your Honda dealer continues to provide after the sale as you are with the quality and dependability of your Honda.

## The Honda Rider's Club (USA only)

---

One of the best ways to get the most enjoyment from owning and riding your Honda is through the Honda Rider's Club of America. Your purchase of a new motorcycle, scooter, ATV or PWC from a participating U.S. Honda dealer entitles you to a complimentary one-year membership in the Club. There are hundreds of HRCA Chapter sponsoring dealers across the USA with events and activities almost every weekend.

Membership benefits include:

- 24 hour, toll-free roadside assistance for your new Honda (includes roadside assistance for your transport vehicle as long as your Honda is aboard or in tow).
- Vehicle transport to the nearest Honda dealer or service center, if necessary.
- An exclusive HRCA website complete with access to the official Honda

Common Service Manual, contests, insider information and more.

- Reimbursement (up to \$75) for Motorcycle Safety Foundation training. Separate free training from the Specialty Vehicle Institute of America for ATV owners.
- One full year of the *Honda Red Rider* magazine or *Honda Red Rider ATV* (for ATV purchasers).
- Discounts from HRCA partners for experienced rider courses.
- Discounted vehicle insurance from the HRCA's insurance partner.
- Racing contingency programs and assistance at selected dual-sport, off-road, and motocross events.

Contact your Honda dealer for more information or call: 1 800-847-HRCA or log on to [www.hrca.honda.com](http://www.hrca.honda.com).



## Reporting Safety Defects (USA only)

---

If you believe that your vehicle has a defect which could cause a crash or could cause injury or death, you should immediately inform the National Highway Traffic Safety Administration (NHTSA) in addition to notifying American Honda Motor Co., Inc.

If NHTSA receives similar complaints, it may open an investigation, and if it finds that a safety defect exists in a group of vehicles, it may order a recall and remedy campaign. However, NHTSA cannot become involved in individual problems between you, your dealer, or American Honda Motor Co., Inc.

To contact NHTSA, you may either call the Auto Safety Hotline toll-free at 1-800-424-9393 (or 366-0123 in Washington, D.C. area) or write to: NHTSA, U.S. Department of Transportation, Washington, D.C. 20590.

You can also obtain other information about motor vehicle safety from the Hotline.



# Table of Contents

---

The following presents the contents of each section of your owner's manual.

<b>MOTORCYCLE SAFETY .....</b>	<b>1</b>
Important Safety Information .....	2
Accessories & Modifications .....	5
Safety Labels .....	7
<b>INSTRUMENTS &amp; CONTROLS .....</b>	<b>9</b>
Component Locations .....	11
Gauges, Indicators & Displays.....	14
Multi-function Display.....	22
Coolant Temperature Meter .....	23
PGM-FI Indicator and Malfunction Indicator Lamp (MIL)...	25
Low Oil Pressure Indicator and Malfunction Indicator Lamp (MIL)...	26
Coolant Temperature Indicator and Malfunction Indicator Lamp (MIL)...	27

HESD Indicator and Malfunction Indicator Lamp (MIL)...	28
Speedometer .....	29
Odometer .....	29
Tripmeter A & B .....	31
Digital Clock .....	32
Changing the Speed and Mileage Unit .....	34
Changing the Temperature Unit .....	35
Presetting the Shift Indicator and Selecting the Display.....	36

# Table of Contents

## **INSTRUMENTS & CONTROLS (cont'd)**

### Controls & Features

Ignition Switch .....	39
Start Button.....	40
Engine Stop Switch .....	40
Headlight Dimmer Switch .....	41
Turn Signal Switch.....	41
Horn Button .....	42
RESET Button.....	42
SEL Button .....	43
HESD (Honda Electronic Steering Damper) .....	44

## **BEFORE RIDING..... 45**

Are You Ready to Ride ? .....	46
Protective Apparel.....	46
Rider Training .....	48
Is Your Motorcycle Ready to Ride ? ....	49
Pre-ride Inspection .....	49

Load Limits & Guidelines.....	52
Loading.....	52
Load Limits .....	53
Loading Guidelines .....	53

## **BASIC OPERATION & RIDING..... 55**

Safe Riding Precautions .....	56
Starting & Stopping the Engine .....	57
Preparation.....	57
Starting Procedure .....	58
Flooded Engine.....	59
Bank Angle Sensor Ignition Cut-off System.....	59
How to Stop the Engine .....	60
Shifting Gears.....	61
Braking .....	63
Parking .....	65
Riding with a Passenger or Cargo.....	70

(cont'd)

# Table of Contents

---

## **SERVICING YOUR HONDA ..... 71**

### *Before You Service Your Honda*

The Importance of Maintenance .....	74
Maintenance Safety .....	75
Important Safety Precautions .....	76
Periodic Maintenance .....	78
Maintenance Schedule .....	80
Maintenance Record .....	85

### *Service Preparations*

Component Locations .....	87
Tool Kit .....	90
Owner's Manual Storage .....	91
Seat Removal .....	92
Middle Cowl Removal .....	94
Inner Lower Cowl Removal .....	95
Under Cowl Removal .....	96

## *Service Procedures*

### Fluids & Filters

Fuel .....	97
Engine Oil & Filter .....	101
Coolant .....	111

### Engine

Throttle .....	115
Clutch System .....	117
Engine Idle Speed .....	120

### Chassis

Suspension .....	122
Brakes .....	131
Tires .....	137
Side Stand .....	144
Drive Chain .....	145

## Table of Contents

---

### SERVICING YOUR HONDA (cont'd)

#### Electrical

Battery..... 152

Appearance Care ..... 157

**TIPS..... 165**

Storing Your Honda ..... 166

Transporting Your Motorcycle ..... 169

You & the Environment ..... 170

### TAKING CARE OF THE

**UNEXPECTED ..... 171**

General Guidelines ..... 172

If Your Engine Quits or Won't Start ... 173

If You Have a Flat Tire ..... 178

If Your Engine Overheats ..... 191

If the Low Oil Pressure Indicator

Lights ..... 193

If a Fuse Blows..... 194

If You Crash ..... 198

If You Lose Your Key ..... 199

If Your Battery is Low (or Dead) ..... 200

(cont'd)

# Table of Contents

---

<b>TECHNICAL INFORMATION .....</b>	<b>201</b>
Vehicle Identification.....	202
Specifications .....	205
Break-in Guidelines.....	212
Emission Control Systems .....	213
Catalytic Converter (California only).....	219
Oxygenated Fuels.....	220

<b>CONSUMER INFORMATION .....</b>	<b>223</b>
Authorized Manuals .....	224
Warranty Coverage .....	227
Warranty Service.....	228
Contacting Honda.....	229
Your Honda Dealer .....	230
The Honda Rider's Club (USA only) .....	231
Reporting Safety Defects (USA only) .....	232
<b>TABLE OF CONTENTS .....</b>	<b>234</b>
<b>INDEX .....</b>	<b>240</b>

## **QUICK REFERENCE**





# Index

---

## A

accessories .....	5
air pressure, tires.....	137
American Honda, contacting.....	229
apparel, protective .....	46
appearance care .....	157

## B

bank angle sensor .....	59
battery .....	152
brakes,	
fluid.....	132
front lever adjustment .....	131
pad wear.....	135
braking .....	63
break-in guidelines .....	212

## button,

RESET .....	42
SEL .....	43

## C

capacity, fuel .....	99
care, appearance .....	157
catalytic converter .....	219
chain, drive .....	145
cleaning,	
appearance care .....	157
matte color painted surface .....	163
clock, digital .....	32
clutch system .....	117
color label .....	204
compartment, owner's manual .....	91
component locations,	
indicators and controls .....	11
maintenance .....	87

consumer information .....	223
coolant.....	111
coolant temperature meter .....	23
cowl removal,	
inner lower cowl .....	95
middle cowl .....	94
under cowl .....	96
customer service .....	229

## D

damping, suspension, rear .....	129
defects, safety .....	232
digital clock .....	32
display,	
check .....	16
multi-function .....	22
drive chain .....	145

## E

emission control systems.....	213
engine,	
flooded.....	59
idle speed .....	120
low oil pressure.....	193
number .....	203
oil .....	101
overheats.....	191
pinging .....	98
starting .....	57
stop switch .....	40
stopping.....	60
won't start .....	173
environment .....	170

# Index

---

## F

flat tire.....	178
flooded engine .....	59
frame number .....	203
fuel,	
oxygenated.....	220
recommendation .....	97
tank capacity .....	99
fuses .....	194

## G

gasohol.....	220
gasoline .....	97
gauges, indicators & displays.....	14

## H

headlight dimmer switch .....	41
helmet holder .....	67
high beam indicator .....	14
Honda,	
contacting .....	229
Rider's Club.....	231
dealer.....	230
Honda service manual .....	224
horn button.....	42

## I

identification, vehicle.....	202
idle speed, engine .....	120
ignition cutoff system,	
bank angle.....	59
side stand .....	57

ignition switch .....	39
indicators.....	14
inspection, pre-ride .....	49

## K

key, lost.....	199
kit, tool.....	90

## L

labels, safety .....	7
lamp check.....	15
limit, weight.....	53
load limits .....	53
loading guidelines.....	53
location, components, indicators & controls .....	11
maintenance .....	87
lock, steering.....	66

## M

maintenance, importance .....	74
periodic .....	78
record .....	85
safety.....	75
schedule .....	80
malfunction indicator lamp (MIL)...	14, 18
manual, service .....	224
maximum weight limit .....	53
matte painted surface, clean.....	163
meter check.....	15
modifications .....	6

## N

numbers, serial.....	202
----------------------	-----

# Index

---

## O

odometer .....	14, 29
oil,	
engine.....	101
low pressure.....	193
operating controls .....	39
overheat, engine.....	191
owner's manual storage.....	91
oxygenated fuels.....	220

## P

parking .....	65
pinging, engine .....	98
pre-load, suspension	
front .....	124
rear .....	128

pre-ride inspection.....	49
problems, unexpected.....	171
protective apparel .....	46

## R

removal,	
inner lower cowl.....	95
middle cowl .....	94
under cowl .....	96
seat .....	92
reporting safety defects.....	232
RESET button.....	42
rider training .....	3, 48
Rider's Club, Honda.....	231

riding,	
basic operation.....	55
clothing .....	46
precautions.....	56
safety.....	2
safety precautions.....	56
with passenger or cargo.....	70

## S

safety,	
important precautions .....	76
labels .....	7
reporting defects.....	232
riding precautions .....	56
schedule, maintenance.....	80
seat removal.....	92
SEL button.....	43
sensor, bank angle .....	59
serial numbers.....	202

service,	
customer.....	229
manuals .....	224
warranty .....	228
shifting gears .....	61
shift indicator.....	36
side stand .....	144
side stand ignition cutoff system .....	57
spark knock.....	98
specifications .....	205
speedometer .....	14, 29
stand, side .....	144
start button .....	40
starting,	
engine.....	57
troubleshooting .....	174
steering lock.....	66
stop switch, engine .....	40
stopping engine.....	60

(cont'd)

# Index

---

storage,	
motorcycle .....	166
owner's manual .....	91
suspension,	
front suspension adjustment.....	123
front suspension spring pre-load.....	124
front suspension damping .....	125
rear suspension adjustment .....	127
rear suspension spring pre-load.....	128
rear suspension damping .....	129
switch,	
engine stop.....	40
headlight dimmer.....	41
ignition.....	39
turn signal .....	41

## T

tachometer .....	14, 17
temperature meter, coolant.....	23
theft prevention tips.....	68
throttle.....	115
tires,	
air pressure.....	137
flat.....	178
replacing .....	141
tool kit.....	90
training, rider .....	3, 48
transporting your motorcycle .....	169
tripmeter.....	14, 31
trouble, unexpected .....	171
troubleshooting, starting.....	174
turn signal indicators .....	14

## V

vehicle identification no. (VIN)..... 202

## W

warranty,  
    coverage..... 227  
    extended..... 227  
    service ..... 228  
washing your motorcycle ..... 157  
weight limit..... 53  
wheels,  
    front removal ..... 181  
    rear removal..... 187









## Quick Reference

---

The following is a brief, but important collection of information you need to know about your Honda. You'll also find space to record important notes.

### How To Avoid Costly Repairs

The engine of your Honda can be the most expensive component to repair. Proper maintenance, especially the use of the recommended fluids and filters, prevents premature wear and damage.

Frequent causes of costly repairs are:

- Engine oil: insufficient quantity, improper oil.
- Air cleaner: dirty, leaking because of improper installation (poor seal).

Record important information on the following page:

## Quick Reference

---

VIN/Frame No.	
Engine No.	
Frame No.	
Ignition Key No.	
Color Label	
Owner's Name	
Address	
City/State	
Phone	
Dealer's Name	
Address	
City/State	
Phone	
Service Mgr.	

Quick Reference

## Quick Reference

Scheduled Maintenance	Initial: 600 miles (1,000 km) Regular: every 4,000 miles (6,400 km)
Pre-ride Inspection	Check the following items each time before you ride (page 49): tires & wheels, chain, leaks, loose parts, throttle, brakes, indicators, lights.
Periodic Checks	Check the following items monthly (page 79): tires & wheels, fluids, lights, freeplay, drive chain, fuses, nuts & bolts.
Fuel/Capacity	premium unleaded gasoline, pump octane number 91 or higher <b>4.76 US gal (18.0 l)</b>
Engine Oil	API Service Classification SG or higher except oils labeled as energy conserving on the circular API service label, SAE 10W-40, JASO T 903 standard MA, Pro Honda GN4 or HP4 (without molybdenum additives) 4-stroke oil or equivalent
Maximum Weight Capacity	<b>366 lbs (166 kg)</b> <b>375 lbs (170 kg) Canada</b> rider, passenger, all cargo and accessories

## Quick Reference

---

Tires	Front: 120/70ZR17M/C (58W) BRIDGESTONE BT014F RADIAL G or PIRELLI DIABLO CORSA H
Type:	Rear: 190/50ZR17M/C (73W) BRIDGESTONE BT014R RADIAL G or PIRELLI DIABLO CORSA H Type: radial, tubeless
Tire Pressure (cold)	Front: 36 psi (250 kPa , 2.50 kgf/cm <sup>2</sup> ) Rear: 42 psi (290 kPa , 2.90 kgf/cm <sup>2</sup> )
Spark Plugs	standard: IMR9C-9HES (NGK) VUH27ES (DENSO)
Coolant	ethylene glycol antifreeze (silicate-free) for aluminum engines in 50/50 solution with Pro Honda HP Coolant or an equivalent distilled water
Fuses	main: 30A FI: 20A other: 10A, 20A

## Quick Reference