

This manual should be considered a permanent part of the scooter and should remain with the scooter when it is resold.

This Owner's Manual covers the FSC600D and FSC600A models. You may find descriptions of equipment and features that are not on your particular model. All illustrations are based on the FSC600A model.

This publication includes the latest production information available before printing. Honda Motor Co., Ltd. reserves the right to make changes at any time without notice and without incurring any obligation.

No part of this publication may be reproduced without written permission.

© 2004 Honda Motor Co., Ltd.

**2005  
Honda FSC600D/A  
SILVER WING  
OWNER'S MANUAL**

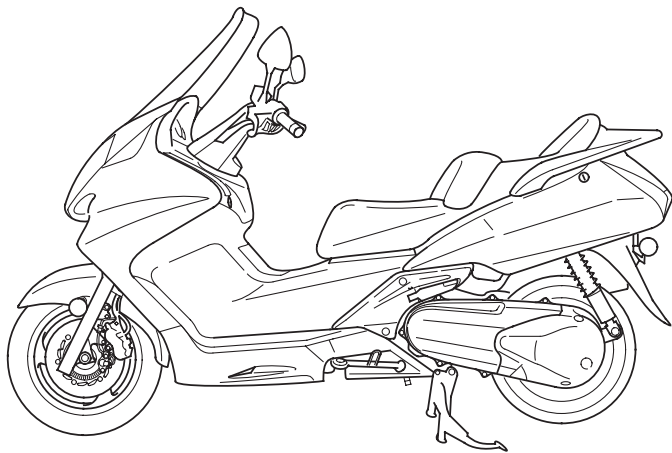

# Introduction

---

Congratulations on choosing your Honda scooter.

When you own a Honda, you're part of a worldwide family of satisfied customers — people who appreciate Honda's reputation for building quality into every product.

Before riding, take time to get acquainted with your scooter and how it works. To protect your investment, we urge you to take responsibility for keeping your scooter well maintained. Scheduled service is a must, of course. But it's just as important to observe the break-in guidelines, and perform all pre-ride and other periodic checks detailed in this manual.

We also recommend that you read this owner's manual before you ride. It's full of facts, instructions, safety information, and helpful tips. To make it easy to use, the manual contains a detailed list of topics at the beginning of each section, and both an in-depth table of contents and an index at the back of the book.

As you read this manual, you will find information that is preceded by a **NOTICE** symbol. This information is intended to help you avoid damage to your Honda, other property, or the environment.

## Introduction

---

Read the Warranties Booklet (page 215 ) thoroughly so you understand the coverages that protect your new Honda and are aware of your rights and responsibilities.

If you have any questions, or if you ever need special service or repairs, remember that your Honda dealer knows your scooter best and is dedicated to your complete satisfaction.

Please report any change of address or ownership to your Honda dealer so we will be able to contact you concerning important production information.

You may also want to visit our website at [www.honda.com](http://www.honda.com).

Happy riding!

California Proposition 65 Warning

**WARNING:** This product contains or emits chemicals known to the State of California to cause cancer and birth defects or other reproductive harm.

## A Few Words About Safety

---

Your safety, and the safety of others, is very important. And operating this scooter safely is an important responsibility.

To help you make informed decisions about safety, we have provided operating procedures and other information on labels and in this manual. This information alerts you to potential hazards that could hurt you or others.

Of course, it is not practical or possible to warn you about all hazards associated with operating or maintaining a scooter. You must use your own good judgment.

You will find important safety information in a variety of forms, including:

- **Safety Labels** — on the scooter.
- **Safety Messages** — preceded by a safety alert symbol  and one of three signal words: **DANGER, WARNING, or CAUTION.**

These signal words mean:

### Safety Messages

## A Few Words About Safety

---

### **DANGER**

You **WILL** be **KILLED** or **SERIOUSLY HURT** if you don't follow instructions.

### **WARNING**

You **CAN** be **KILLED** or **SERIOUSLY HURT** if you don't follow instructions.

### **CAUTION**

You **CAN** be **HURT** if you don't follow instructions.

- **Safety Headings** — such as Important Safety Reminders or Important Safety Precautions.
- **Safety Section** — such as Scooter Safety.
- **Instructions** — how to use this scooter correctly and safely.

This entire manual is filled with important safety information — please read it carefully.

# Contents

---

These pages give an overview of the contents of your owner's manual. The first page of each section lists the topics covered in that section.

## **Scooter Safety ..... 1**

Important safety information you should know, plus a look at the safety-related labels on your scooter.

## **Instruments & Controls..... 9**

The location and function of indicators and controls on your scooter and operating instructions for various controls and features.

## **Before Riding ..... 35**

The importance of wearing a helmet and other protective gear, how to make sure you and your scooter are ready to ride, and important information about loading.

## **Basic Operation & Riding ..... 53**

How to start and stop the engine, and use the brakes. Also, includes riding precautions and important information about riding with a passenger or cargo.

# Contents

---

## **Servicing Your Honda ..... 77**

Why your scooter needs regular maintenance, what you need to know before servicing your Honda, an owner maintenance schedule, and instructions for specific maintenance and adjustment items.

## **Tips..... 163**

How to store and transport your scooter and how to be an environmentally-responsible rider.

## **Taking Care of the Unexpected ..... 169**

What to do if you have a flat tire, your engine won't start, etc.

## **Technical Information ..... 191**

ID numbers, technical specifications, and other technical facts.

## **Consumer Information..... 211**

Information on warranties, emission controls, how to get Honda service manuals, and...

## **“Reporting Safety Defects” ..... 220**

## **Table of Contents ..... 222**

Sequential listing of topics in this owner's manual.

## **Index..... 228**

## **Quick Reference**

Handy facts about fuel, engine oil, tire sizes, and air pressures.





# Scooter Safety

---

This section presents some of the most important information and recommendations to help you ride your scooter safely. Please take a few moments to read these pages. This section also includes information about the location of safety labels on your scooter.

Important Safety Information .....	2
Accessories & Modifications .....	5
Safety Labels .....	7

## Important Safety Information

---

Your scooter can provide many years of service and pleasure — if you take responsibility for your own safety and understand the challenges you can meet while riding.

There is much that you can do to protect yourself when you ride. You'll find many helpful recommendations throughout this manual. The following are a few that we consider most important.

### **Always Wear a Helmet**

It's a proven fact: helmets significantly reduce the number and severity of head injuries. So always wear an approved motorcycle helmet and make sure your passenger does the same. We also recommend that you wear eye protection, sturdy boots, gloves, and other protective gear (page 36 ).

# Important Safety Information

---

## **Take Time to Learn & Practice**

Even if you have ridden other scooters, take time to become familiar with how this scooter works and handles. Practice in a safe area until you build your skills and get accustomed to the scooter's size and weight.

Because many accidents involve inexperienced or untrained riders, we urge all riders to take a certified course approved by the Motorcycle Safety Foundation (MSF). See page 38 .

## **Ride Defensively**

The most frequent scooter collision happens when a car turns left in front of a scooter. Another common situation is a car moving suddenly into your lane.

Always pay attention to other vehicles around you, and do not assume that other drivers see you. Be prepared to stop quickly or make an evasive maneuver. For other riding tips, see the booklet, *You and Your Motorcycle: Riding Tips and Practice Guide*, which came with your new scooter (USA only).

## **Make Yourself Easy to See**

Some drivers do not see scooters because they are not looking for them. To make yourself more visible, wear bright reflective clothing, position yourself so other drivers can see you, signal before turning or changing lanes, and use your horn when it will help others notice you.

## **Important Safety Information**

---

### **Ride within Your Limits**

Pushing limits is another major cause of scooter accidents. Never ride beyond your personal abilities or faster than conditions warrant. Remember that alcohol, drugs, fatigue, and inattention can significantly reduce your ability to make good judgments and ride safely.

### **Don't Drink and Ride**

Alcohol and riding don't mix. Even one drink can reduce your ability to respond to changing conditions, and your reaction time gets worse with every additional drink. So don't drink and ride, and don't let your friends drink and ride either.

### **Keep Your Honda in Safe Condition**

It's important to keep your scooter properly maintained and in safe riding condition. To help avoid problems, inspect your scooter before every ride and perform all recommended maintenance. Never exceed load limits (page 44 ), and do not modify your scooter (page 6 ) or install accessories that would make your scooter unsafe (page 5 ).

## Accessories & Modifications

Modifying your scooter or using non-Honda accessories can make your scooter unsafe. Before you consider making any modifications or adding an accessory, be sure to read the following information.

### **WARNING**

Improper accessories or modifications can cause a crash in which you can be seriously hurt or killed.

Follow all instructions in this owner's manual regarding accessories and modifications.

### Accessories

We strongly recommend that you use only genuine Honda accessories that have been specifically designed and tested for your scooter. Because Honda cannot test all other accessories, you must be personally responsible for proper selection, installation, and use of non-Honda accessories.

Check with your Honda dealer for assistance and always follow these guidelines:

- Make sure the accessory does not obscure any lights, reduce ground clearance and lean angle, limit suspension travel or steering travel, alter your riding position, or interfere with operating any controls. (cont'd)

## Accessories & Modifications

---

- Do not add any electrical equipment that will exceed the scooter's electrical system capacity (page 198 ). A blown fuse can cause a loss of lights or engine power (page 183 ).
- Do not pull a trailer or sidecar with your scooter. This scooter was not designed for these attachments, and their use can seriously impair your scooter's handling.

### Modifications

We strongly advise you not to remove any original equipment or modify your scooter in any way that would change its design or operation. Such changes could seriously impair your scooter's handling, stability, and braking, making it unsafe to ride.

Removing or modifying your lights, exhaust system, emission control system, or other equipment can also make your scooter illegal.

## Safety Labels

Safety labels on your scooter either warn you of potential hazards that could cause serious injury or they provide important safety information. Read these labels carefully and don't remove them.

If a label comes off or becomes hard to read, contact your Honda dealer for a replacement.

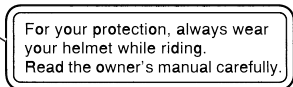
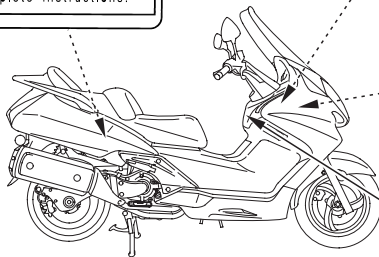
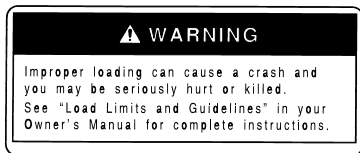



# Safety Labels

< For USA >

TIRE INFORMATION		
Cold tire pressures: [Up to maximum weight capacity]		
Front	200kPa 2.00kg/cm <sup>2</sup>	29psi
Rear	250kPa 2.50kg/cm <sup>2</sup>	36psi
[Up to 90kg (200lbs) load]		
Front	200kPa 2.00kg/cm <sup>2</sup>	29psi
Rear	225kPa 2.25kg/cm <sup>2</sup>	33psi
Maximum weight capacity: 166kg(366lbs)		
Tire size: Front 120/80-14M/C 58S		
Rear 150/70-13M/C 64S		
Tire brand	BRIDGESTONE	IRC
Front	HOOP B03	SS530F
Rear	HOOP B02	SS530R
Min. recommend tire center tread depth:		
Front 1.5mm(0.06in.)		Rear 2.0mm(0.08in.)
This motorcycle is equipped with tubeless tires.		Read owner's manual.

< For Canada >

TIRE INFORMATION		
Cold tire pressures: [Up to maximum weight capacity]		
Front	200kPa 2.00kg/cm <sup>2</sup>	29psi
Rear	250kPa 2.50kg/cm <sup>2</sup>	36psi
[Up to 90kg (200lbs) load]		
Front	200kPa 2.00kg/cm <sup>2</sup>	29psi
Rear	225kPa 2.25kg/cm <sup>2</sup>	33psi
Maximum weight capacity: 170kg(375lbs)		
Tire size: Front 120/80-14M/C 58S		
Rear 150/70-13M/C 64S		
Tire brand	BRIDGESTONE	IRC
Front	HOOP B03	SS-530F
Rear	HOOP B02	SS-530R
Min. recommend tire center tread depth:		
Front 1.5mm(0.06in.)		Rear 2.0mm(0.08in.)
This motorcycle is equipped with tubeless tires.		Read owner's manual.

Glove Box  
Max. weight limit  
1.0kg / 2.0lbs

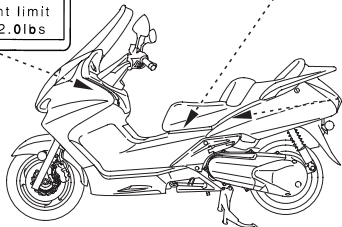

Max. weight limit  
10kg / 22lbs

## Instruments & Controls

---

This section shows the location of all gauges, indicators, and controls you would normally use before or while riding your scooter.

The items listed on this page are described in this section. Instructions for other components are presented in other sections of this manual where they will be most useful.

Component Locations .....	10
Gauges, Indicators & Displays.....	13
Multi-function Display.....	20
Coolant Temperature Meter .....	21
Fuel Gauge.....	23
Odometer/Tripmeter A & B.....	24
Digital Clock .....	25
Controls & Features	
Ignition Switch .....	28
Start Button.....	29
Engine Stop Switch .....	29
Headlight Dimmer Switch .....	30
Turn Signal Switch.....	30
Horn Button .....	31
RESET Button.....	31
MODE Button .....	31
Parking Brake Lock.....	32

# Component Locations

---

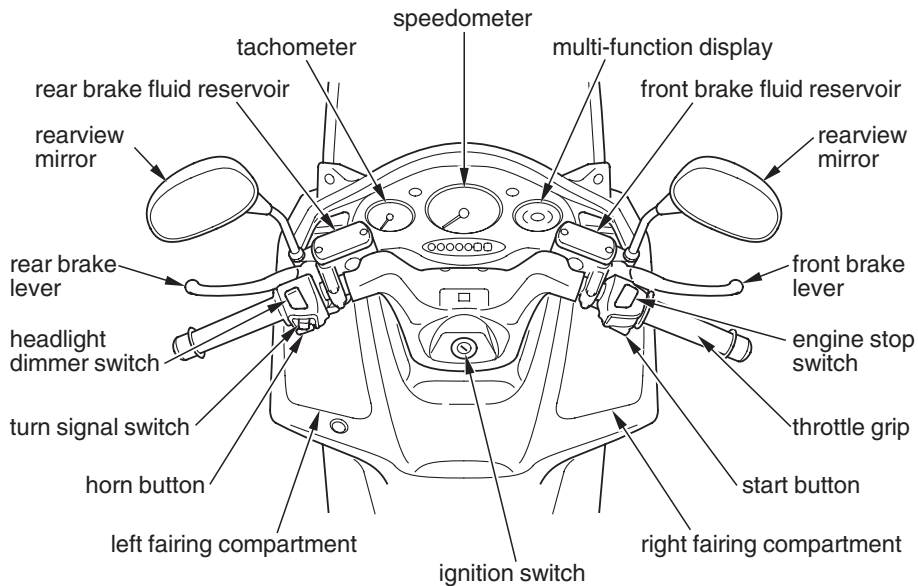

# Component Locations

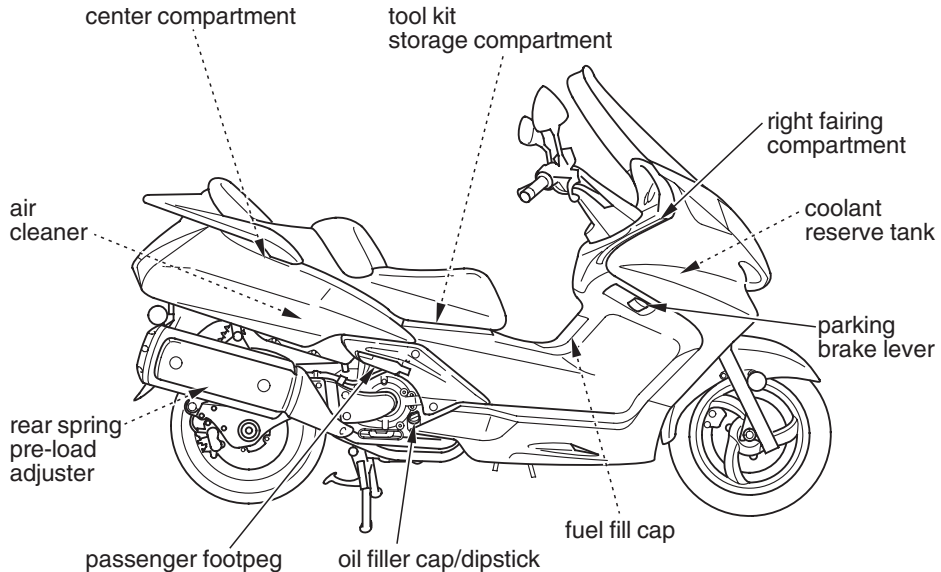

# Component Locations

---

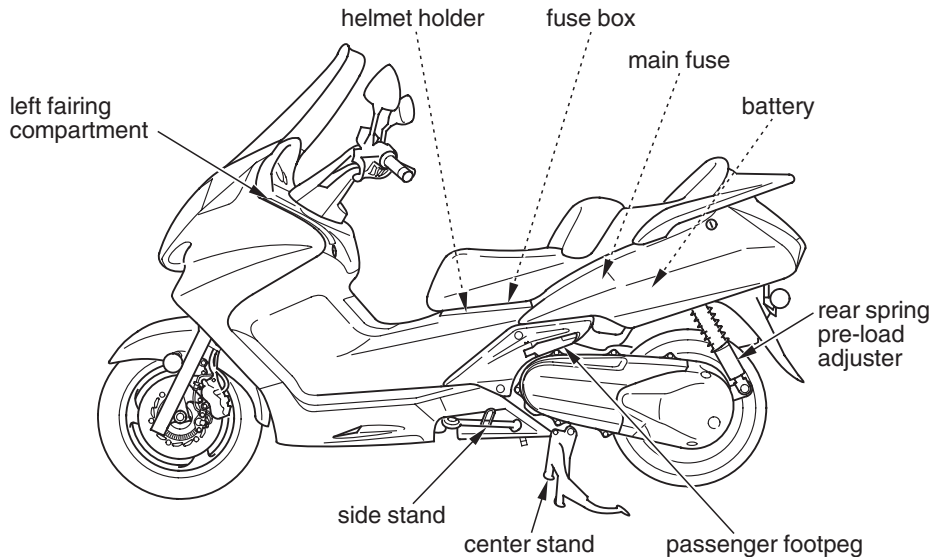

## Gauges, Indicators & Displays

The gauges and indicators on your scooter keep you informed, alert you to possible problems, and make your riding safer and more enjoyable. Refer to the gauges and indicators frequently. Their functions are described on the following pages.

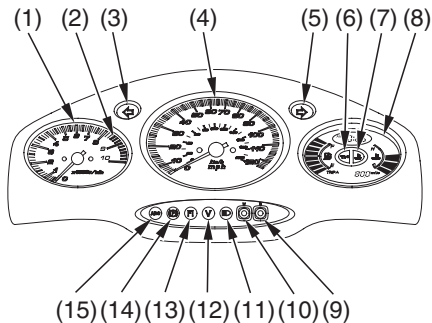

- (1) tachometer
- (2) tachometer red zone
- (3) left turn signal indicator
- (4) speedometer
- (5) right turn signal indicator
- (6) low oil pressure indicator
- (7) coolant temperature indicator
- (8) multi-function display
- (9) RESET button
- (10) MODE button
- (11) high beam indicator
- (12) V-matic indicator
- (13) PGM-FI malfunction indicator lamp (MIL)
- (14) parking brake indicator
- (15) anti-lock brake system (ABS) indicator (FSC600A)

USA: Odometer & tripmeter read in miles.  
Canada: Odometer & tripmeter read in kilometers.

## Gauges, Indicators & Displays

---

### Lamp Check

The low oil pressure indicator comes on when you turn the ignition switch ON so you can check that it is working. The indicator remains on until after the engine is started.

The coolant temperature indicator, PGM-FI malfunction indicator lamp (MIL) and V-matic indicator light for a few seconds and then go off when you turn the ignition switch ON.

These indicators are identified in the table on pages 16 – 19 with the words: *Lamp Check*.

When applicable, the parking brake and high beam indicators come on when you turn the ignition switch ON and remains on until you release the parking brake lever or select the low beam.

If one of these indicators does not come on when it should, have your Honda dealer check for burned-out bulbs or other problems.

## Gauges, Indicators & Displays

### Display Check

When the ignition switch is turned ON, the multi-function display ( 1 ) will display from the bottom up in sequence.

Thereafter, it will temporarily show all the modes and digital segments so you can make sure the liquid crystal display is functioning properly.

The displays are identified in the table on page 17 with the words: *Display Check*.

If any part of these displays does not come on when it should, have your Honda dealer check for problems.

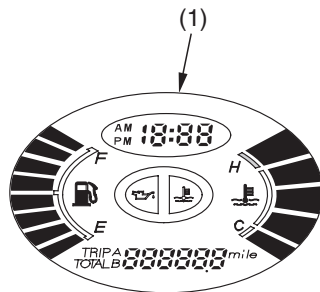

(1) multi-function display



## Gauges, Indicators & Displays

---

1	tachometer	Shows engine speed in revolutions per minute (rpm).
2	tachometer red zone	Shows excessive engine rpm range (indicated from the beginning of the tachometer red zone) in which operation may damage the engine. Do not let the tachometer needle enter the red zone.
3	left turn signal indicator (amber)	Flashes when the left turn signal operates.
4	speedometer	Shows riding speed in miles (USA) or kilometers (Canada) per hour.
5	right turn signal indicator (amber)	Flashes when the right turn signal operates.
6	low oil pressure indicator (red)	Lights when engine oil pressure is low enough to cause engine damage. If the low oil pressure indicator lights during operation, pull safely to the side of the road. See page 182 for instructions and cautions. <i>Lamp Check</i> .

## Gauges, Indicators & Displays

7	coolant temperature indicator (red)	Lights when the coolant is over the specified temperature. If the indicator comes on, pull safely to the side of the road. See page 180 for instructions and cautions. <i>Lamp Check.</i>
8	multi-function display	The display includes the following functions: <i>Display Check.</i>
	coolant temperature meter	Shows coolant temperature (page 21 ).
	fuel gauge	Shows approximate fuel supply available (page 23 ).
	odometer	Shows the total miles (USA) or kilometers (Canada) ridden.
	tripmeter A & B	Shows the number of miles (USA) or kilometers (Canada) ridden since you last reset the meter. The tripmeter has two sub modes, “A” and “B.” To zero (0) the tripmeter, press the RESET button (page 24 ).
	digital clock	Shows hour and minute (page 25 ).

## Gauges, Indicators & Displays

---

9	RESET button	Resets the tripmeter to zero (0) (page 24 ). Also used to set the digital clock (page 25 ).
10	MODE button	Selects tripmeter A, tripmeter B, or odometer (page 24 ). Also used to set the digital clock (page 25 ).
11	high beam indicator (blue)	Lights when the headlight is on high beam.
12	V-matic indicator (amber)	Lights when V-matic parts have to be replaced. If the indicator lights, see your Honda dealer. <i>Lamp Check.</i>

## Gauges, Indicators & Displays

13	PGM-FI malfunction indicator lamp (MIL) (red)	Flashes when there is any abnormality in the PGM-FI (Programmed Fuel Injection) system. Should also light for a few seconds and then go off when the ignition switch is turned ON and the engine stop switch is at RUN. If the indicator comes on at any other time, reduce speed and take your motorcycle to a Honda dealer as soon as possible. <i>Lamp Check.</i>
14	parking brake indicator (red)	Lights as a reminder that you have not released the parking brake lever.
15	anti-lock brake system (ABS) indicator (red) (FSC600A)	Lights when there is any abnormality in the anti-lock brake system (ABS). Normally, this indicator comes on when the ignition switch is turned ON, and goes off after you ride the scooter at a speed above 6 mph (10 km/h). If the indicator comes on while riding, stop the scooter in a safe place and turn off the engine. Refer to <i>ABS indicator light</i> , page 71 . For information about ABS, see page 70 . <i>Lamp Check.</i>

# Gauges, Indicators & Displays

## Multi-function Display

The multi-function display (1) includes the following functions:

- coolant temperature meter
- fuel gauge
- odometer/tripmeter A & B
- digital clock

Both the digital clock and tripmeter will reset if the battery is disconnected.

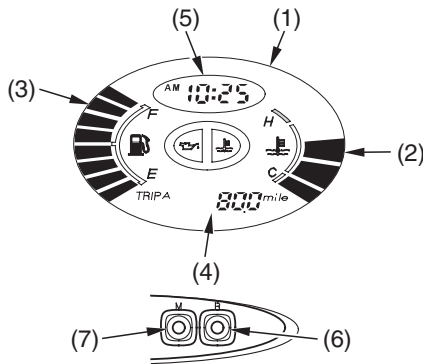

- (1) multi-function display
- (2) coolant temperature meter
- (3) fuel gauge
- (4) odometer/tripmeter A & B
- (5) digital clock
- (6) RESET button
- (7) MODE button

### Coolant Temperature Meter

The coolant temperature meter (1) shows the coolant temperature digitally.

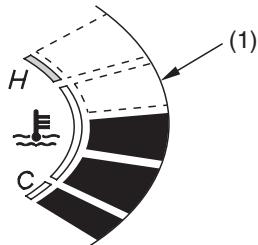

(1) coolant temperature meter

## Gauges, Indicators & Displays

---

### Overheating Message:

When the coolant temperature rises above a certain level, segment H (2) goes on. At the same time, the coolant temperature indicator (3) lights.

If this occurs, stop the engine and check the reserve tank coolant level. Read pages 118 — 121 and do not ride the scooter until the problem has been corrected.

#### **NOTICE**

*Continuing to ride with an overheated engine can cause serious engine damage.*

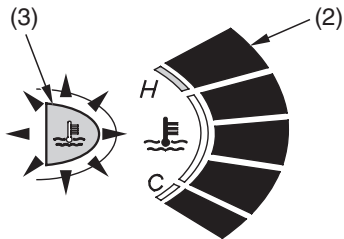

(2) segment H

(3) coolant temperature indicator

### Fuel Gauge

The fuel gauge liquid crystal display (1) shows the approximate fuel supply available in a graduated display. When segment F (2) goes on, the fuel tank capacity is:

4.23 US gal (16.0 ℓ)

When segment E (3) flashes, you should refill the tank as soon as possible.

The amount of fuel remaining when the flashing starts is approximately:

0.95 US gal (3.6 ℓ)

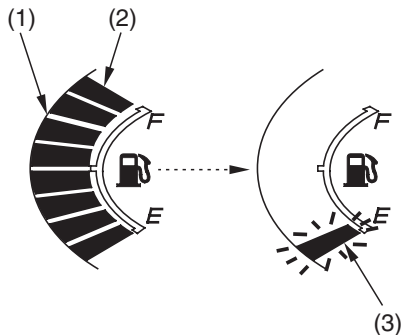

- (1) fuel gauge
- (2) segment F
- (3) segment E



# Gauges, Indicators & Displays

## Odometer/Tripmeter A & B

The odometer (1) shows the total miles (USA) or kilometers (Canada) ridden.

The tripmeter A (2) and tripmeter B (3) show number of miles (USA) or kilometers (Canada) ridden since you last reset the meter.

To select the odometer, tripmeter A or tripmeter B, push the MODE button (4).

To reset the tripmeter, push and hold the RESET button (5) when the display is in the tripmeter A or tripmeter B.

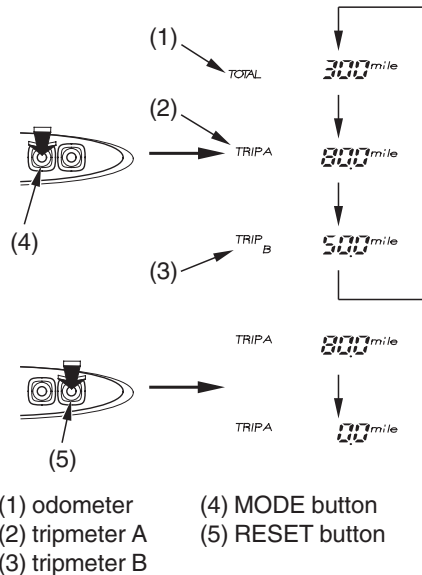

## Digital Clock

The digital clock (1) shows the hour and minute. To adjust the time, proceed as follows:

1. Turn the ignition switch ON.
2. Press and hold both the MODE button (2) and RESET button (3) for more than 2 seconds. The clock will be set in the adjust mode with the hour display flashing.

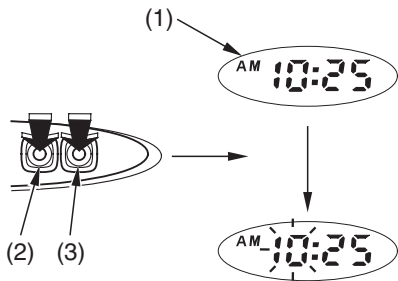

- (1) digital clock
- (2) MODE button
- (3) RESET button

(cont'd)

## Gauges, Indicators & Displays

---

3. To set the hour, press the RESET button until the desired hour and AM/PM are displayed.

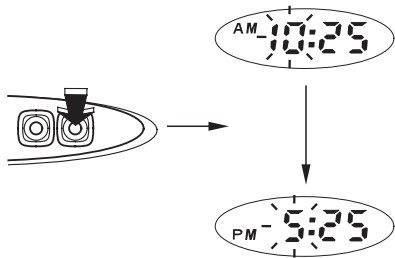

4. Press the MODE button. The minute display will start flashing.

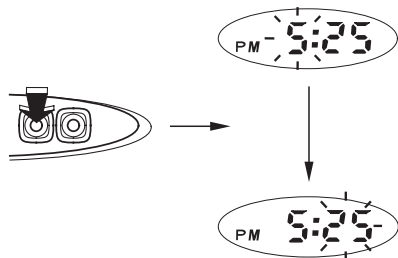

## Gauges, Indicators & Displays

5. To set the minute, press the RESET button until the desired minute is displayed. The minute display will return to “00” when “60” is reached without affecting the hour display.

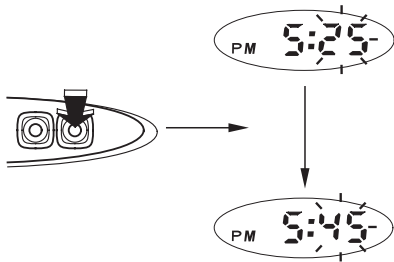

6. To end the adjustment, press the MODE button or turn the ignition switch OFF. The display will stop flashing automatically and the adjustment will be cancelled if the button is not pressed for about 2 minutes.

# Controls & Features

## Ignition Switch

The ignition switch (1) is used for starting and stopping the engine (page 55) and to lock the steering for theft prevention (page 73). Insert the key and turn it to the right for the ON position. Push down on the key and turn it to the left to the LOCK (steering lock) position.

Key Position	Function
ON	Electrical circuits on.
OFF	No electrical circuits function.
LOCK (steering lock)	No electrical circuits function. Locks the steering head.

FRONT

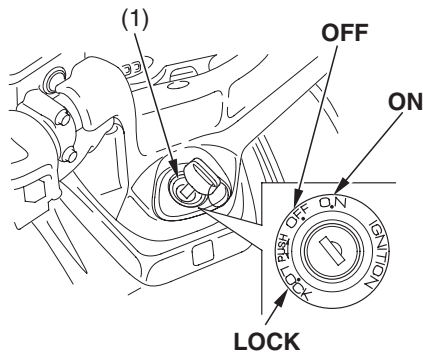

(1) ignition switch

To unlock the steering lock, insert and push down on the key and turn it to the right to the OFF position.

### Start Button



The start button (1) is used for starting the engine. Pushing the button in starts the engine. See *Starting Procedure*, page 56.

When the start button is pushed, the starter motor will crank the engine; the headlight will automatically go out, but the taillight will stay on.

The starter motor will not operate if the engine stop switch is in the OFF position when the start button is pushed.

The electric starter will only work when the rear brake lever is pulled in and the side stand is up.

### Engine Stop Switch



#### RIGHT HANDLEBAR

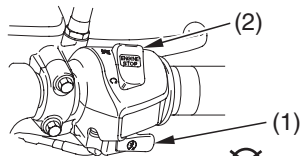

(1) start button

(2) engine stop switch



OFF



RUN

The engine stop switch (2) is used to stop the engine in an emergency. To operate, push the switch to the OFF position. The switch must be in the RUN position to start the engine, and it should normally remain in the RUN position even when the engine is OFF.

(cont'd)

## Controls & Features

If your scooter is stopped with the ignition switch ON and the engine stop switch OFF, the headlight and taillight will remain on, resulting in battery discharge.



### Headlight Dimmer Switch

The headlight dimmer switch (1) is used to change between the high and low beams of the headlight. To operate, turn the switch to HI for high beam, LO for low beam.

### Turn Signal Switch

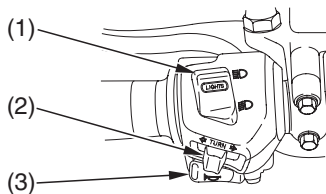
The turn signal switch (2) is used to signal a turn or a lane change. To operate, move the switch all the way in the proper direction and release it. The appropriate turn signal lights will start blinking. To cancel the light, push the switch in.



- (1) headlight dimmer switch  HI  
(2) turn signal switch  LO  
(3) horn button

### **Horn Button**

The horn is used to alert other motorists. To operate, push the horn button (3).

### **RESET Button**

The RESET button is used to reset (zero) the tripmeter. To reset the tripmeter, press and hold the button for about 2–3 seconds (page 24).

The RESET button is also used to set the digital clock (page 25).

### **MODE Button**

The MODE button is used to select odometer, tripmeter A or tripmeter B. To select from one tripmeter to the other, press the button (page 24).

The MODE button is also used to set the digital clock (page 25).



# Controls & Features

---

## Parking Brake Lock

Be sure the parking brake is applied while starting and warming up the engine. The parking brake lock will not function if the parking brake is not adjusted properly (page 141 ).

### To Apply the Brake Lock

Pull the parking brake lever ( 1 ) back to lock the rear wheel.

(See illustration on page 33 ).

The parking brake lock will not be applied if the parking brake is not adjusted properly (page 141 ).

### To Release the Brake Lock

Before starting to ride the scooter, release the parking brake lever ( 1 ) while lightly pulling down on the rear of the lever.

Before riding, check that the parking brake indicator is turned OFF and make sure that the rear brake is fully released so there is no drag on the rear wheel.

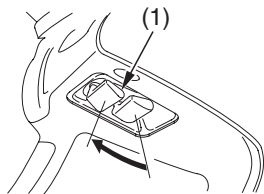

< To apply >

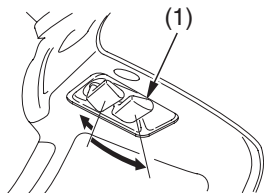

< To release >

(1) parking brake lever



## Before Riding

---

Before each ride, you need to make sure you and your Honda are both ready to ride. To help get you prepared, this section discusses how to evaluate your riding readiness, what items you should check on your scooter, and adjustments to make for your comfort, convenience, or safety. This section also includes important information about loading.

For information about adjusting the suspension on your Honda, see page 132.

Are You Ready to Ride ? .....	36
Protective Apparel.....	36
Rider Training .....	38
Is Your Scooter Ready to Ride ? .....	40
Pre-ride Inspection .....	40
Load Limits & Guidelines.....	43
Loading .....	43
Load Limits .....	44
Loading Guidelines .....	45
Cargo Compartments.....	47
Center Compartment .....	47
Left Fairing Compartment .....	49
Right Fairing Compartment .....	50
Comfort & Convenience .....	51
Adjustable Backrest.....	51
Trunk Light.....	52

## Are You Ready to Ride?

---

Before you ride your scooter for the first time, we urge you to:

- Read this owner's manual.
- Make sure you understand all the safety messages.
- Know how to operate all the controls.

Before each ride, be sure:

- You feel well and are in good physical and mental condition.
- You are wearing an approved motorcycle helmet (with chin strap tightened securely), eye protection, and other protective clothing.
- You don't have any alcohol or drugs in your system.

Make sure your passenger is ready to ride, too, and is wearing proper gear including a helmet.

If you must carry an extra helmet while riding, use a commercially-available elastic cord, strap, or net to secure the helmet to the seat.

### Protective Apparel

For your safety, we strongly recommend that you always wear an approved motorcycle helmet, eye protection, boots, gloves, long pants, and a long-sleeved shirt or jacket whenever you ride.

Although complete protection is not possible, wearing proper gear can reduce the chance of injury when you ride.

Following are suggestions to help you choose the proper gear.

## Are You Ready to Ride?

### Helmets and Eye Protection

Your helmet is your most important piece of riding gear because it offers the best protection against head injuries. A helmet should fit your head comfortably and securely. A bright-colored helmet and reflective strips can make you more noticeable in traffic.

An open-face helmet offers some protection, but a full-face helmet offers more. Regardless of the style, look for a DOT (Department of Transportation) sticker in any helmet you buy (USA only). Always wear a face shield or goggles to protect your eyes and help your vision.

### **⚠ WARNING**

Not wearing a helmet increases the chance of serious injury or death in a crash.

Be sure you and your passenger always wear a helmet, eye protection, and other protective apparel when you ride.

### Additional Riding Gear

In addition to a helmet and eye protection, we also recommend:

- Sturdy boots with non-slip soles to help protect your feet and ankles.
- Leather gloves to help protect your hands.

(cont'd)

## Are You Ready to Ride?

---

- A motorcycle riding suit or jacket for comfort as well as protection. Bright-colored and reflective clothing can help make you more noticeable in traffic. Avoid loose clothes that could get caught on any part of your scooter.

### Rider Training

Developing your riding skills is an ongoing process. Even if you have ridden other scooters, take time to become familiar with how this scooter works and handles. Practice riding the scooter in a safe area to build your skills. Do not ride in traffic until you get accustomed to the scooter's controls, and feel comfortable with its size and weight.

We urge all riders to take a certified course approved by the Motorcycle Safety Foundation (MSF). New riders should start with the basic course, and even experienced riders will find the advanced course beneficial. For information about the MSF training course nearest you, call the national toll-free number: (800) 446-9227.

Other riding tips can be found in the *Riding Tips* booklet that came with your scooter (USA only).

## Are You Ready to Ride?

---

ALWAYS wear a helmet.

You should also wear a face shield or goggles.

Clothes should be close-fitting.

Wear bright or reflective clothing.

Wear gloves.

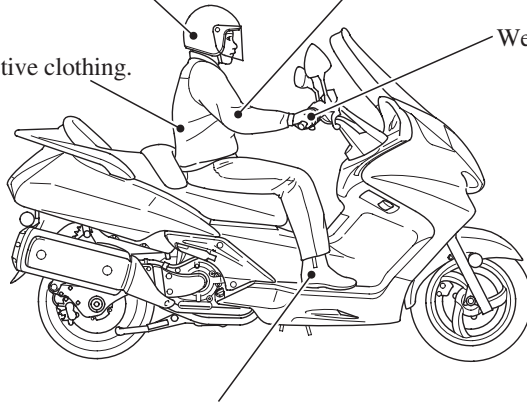

Boots should be close-fitting, have low heels and offer ankle protection.



## Is Your Scooter Ready to Ride?

---

Before each ride, it's important to inspect your scooter and make sure any problem you find is corrected. A pre-ride inspection is a must, not only for safety, but because having a breakdown, or even a flat tire, can be a major inconvenience.

### **WARNING**

Improperly maintaining this scooter or failing to correct a problem before riding can cause a crash in which you can be seriously hurt or killed.

Always perform a pre-ride inspection before every ride and correct any problems.

### **Pre-ride Inspection**

Check the following items before you get on the scooter:

<i>Tires</i>	Look at the tires. If a tire appears low, use an air pressure gauge to check its pressure. Also look for signs of excessive wear (page 142 ) or damage to the tires and wheels.
<i>&amp;</i>	
<i>Wheels</i>	

## Is Your Scooter Ready to Ride?

---

*Leaks,  
Loose  
Parts*

Walk around your scooter and look for anything that appears unusual, such as a leak or loose cable.

*Lights*

Make sure the headlight, brake light, taillight, and turn signals are working properly.

If you are carrying a passenger or cargo, also check the following:

*Load Limits* Make sure you do not exceed the load limits (page 44).

*Cargo* Check that all cargo is secure.

*Adjustments* Adjust the rear suspension (page 133 ) according to your load.

## Is Your Scooter Ready to Ride?

---

Check these items after you get on the scooter:

- Throttle*      Rotate the throttle to check it moves smoothly without binding.
- Brakes*        Pull the front and rear brake levers to check that they operate normally.
- Indicators*    Turn the ignition on and check for normal operation of the gauges and indicators (page 13 ).

If you haven't ridden the scooter in over a week, you should also check other items, such as the oil level and other fluids. See *Periodic Maintenance* (page 84 ). Periodic maintenance should also be done at least once a month, no matter how often you ride.

Remember, be sure to take care of any problem you find, or have your Honda dealer correct it before you ride.

## Load Limits & Guidelines

Your scooter has been designed to carry you and one passenger. When you carry a passenger, you may feel some difference during acceleration and braking. But so long as you keep your scooter well-maintained, with good tires and brakes, you can safely carry loads within the given limits and guidelines.

However, exceeding the weight limit or carrying an unbalanced load can seriously impair your scooter's handling, braking, and stability. Non-Honda accessories, improper modifications, and poor maintenance can also reduce your safety margin.

### Loading

How much weight you put on your scooter, and how you load it, are important to your safety. Anytime you ride with a passenger or cargo, you should be aware of the following information.

#### **WARNING**

Overloading or improper loading can cause a crash and you can be seriously hurt or killed.

Follow all load limits and other loading guidelines in this manual.

# Load Limits & Guidelines

---

## Load Limits

Following are the load limits for your scooter:

**maximum weight capacity:**

366 lbs (166 kg)

375 lbs (170 kg) (Canada only)

includes the weight of the rider, passenger, all cargo, and all accessories.

**maximum cargo weight:**

25 lbs (11.5 kg)

The weight of added accessories will reduce the maximum cargo weight you can carry.

includes following maximum compartment weights:

center compartment: 22 lbs (10 kg)

left fairing

compartment: 2.0 lbs (1.0 kg)

right fairing

compartment: 1.1 lbs (0.5 kg)

The left and right fairing compartment are for lightweight items.

## Load Limits & Guidelines

center compartment;  
weight limit — 22 lbs (10 kg)

left fairing compartment;  
weight limit — 2.0 lbs (1.0 kg)

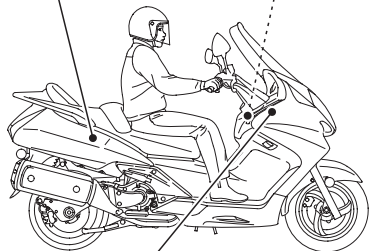

right fairing compartment;  
weight limit — 1.1 lbs (0.5 kg)

### Loading Guidelines

Your scooter is primarily intended for transporting you and a passenger. You may wish to secure a jacket or other small items to the seat when you are not riding with a passenger.

If you wish to carry more cargo, check with your Honda dealer for advice, and be sure to read the information regarding accessories on page 5 .

(cont'd)

## Load Limits & Guidelines

---

Improperly loading your scooter can affect its stability and handling. Even if your scooter is properly loaded, you should ride at reduced speeds and never exceed 80 mph (130 km/h) when carrying cargo.

Follow these guidelines whenever you carry a passenger or cargo:

- Check that both tires are properly inflated, and that pressure in the rear tire is increased to suit the load (page 142 ).
- If you change your normal load, you may need to adjust the rear suspension (page 133 ).
- To prevent loose items from creating a hazard, make sure that all cargo is tied down securely before you ride.
- Place cargo weight as low and close to the center of your scooter as possible.
- Balance cargo weight evenly on both sides.

# Cargo Compartments

## Center Compartment

The center compartment (1) is designed to carry up to 22 lbs (10 kg).

However, regardless of compartment capacity, be sure you do not exceed the maximum load and cargo weight limits.

### To Open the Center Compartment

Insert the ignition key (2) into the seat lock (3) and turn it clockwise.

### To Close the Center Compartment

1. Lower and push down on the opposite side of the hooks (4) until it locks.
2. Remove the ignition key from the seat lock.

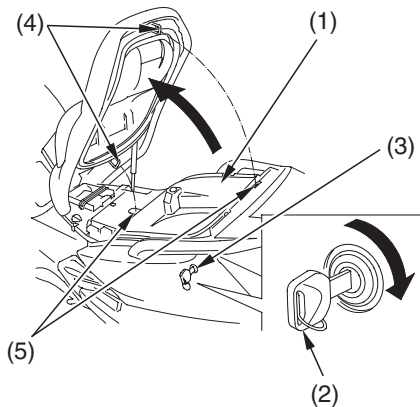

- (1) Center compartment
- (2) ignition key
- (3) seat lock
- (4) hooks
- (5) seat catch

(cont'd)



## Cargo Compartments

---

Before riding, make sure the seat is closed securely. If not closed, the center compartment light will remain lit, resulting in battery discharge.

Do not place luggage or clothing near the seat catch (5). It could make the seat difficult to open if it gets caught between the seat hook and catch while closing the seat.

# Cargo Compartments

## Left Fairing Compartment

The left fairing compartment (1) is for lightweight items.

Cargo in the left fairing compartment should not exceed:

2.0 lbs (1.0 kg)

Be careful not to flood this area when washing your scooter.

### To Open the Left Fairing Compartment

Insert the ignition key (2) and turn it clockwise.

### To Close the Left Fairing Compartment

Holding the left fairing compartment cover (3) closed, turn the ignition key counterclockwise.

Remove the ignition key.

Make sure the cover is closed securely.

### BELOW HANDLEBAR

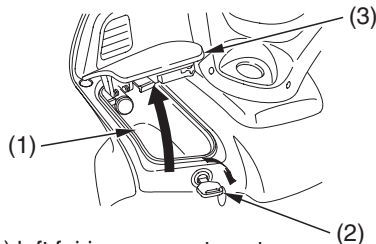

(1) left fairing compartment

(2) ignition key

(3) left fairing compartment cover

# Comfort & Convenience

---

## Right Fairing Compartment

The right fairing compartment (1) is for lightweight items.

Cargo in the right fairing compartment should not exceed:

1.1 lbs (0.5 kg)

Be careful not to flood this area when washing your scooter.

### To Open the Right Fairing Compartment

Push in near the bottom of the right fairing compartment cover (2).

### To Close the Right Fairing Compartment

Push the cover closed and check that it is secure.

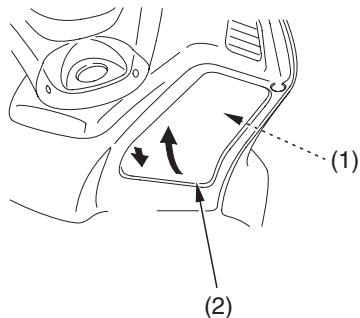

(1) right fairing compartment

(2) right fairing compartment cover

Do not open and close the right fairing compartment while riding the scooter.

### Adjustable Backrest

The seat is equipped with a backrest (1) which allows the seat to be adjusted to the rider's preference.

#### To Adjust the Backrest

Open the seat (page 47), remove the bolts (2) on the back and move the backrest back and forth to the rider's preference. Install the bolts.

After cleaning or riding in the rain, wipe off water collected under the backrest before riding the scooter again.

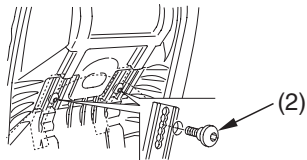
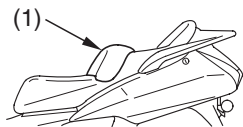

- (1) backrest
- (2) bolts

## Comfort & Convenience

---

### Trunk Light

The trunk light (1) turns ON automatically when the seat is opened. It remains ON as long as the seat is opened regardless of the position of the ignition switch.

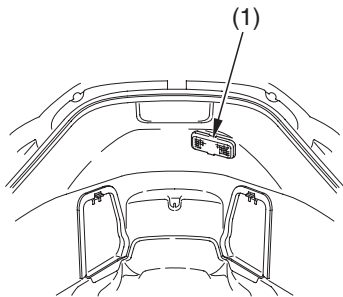

(1) trunk light

## Basic Operation & Riding

---

This section gives basic riding instructions, including how to start and stop your engine, and how to use the throttle and brakes. It also provides important information on riding with a passenger or cargo.

To protect your new engine and enjoy optimum performance and service life, refer to Break-in Guidelines (page 201 ).

To protect the catalytic converter in your scooter's exhaust system, avoid extended idling and the use of leaded gasoline.

Safe Riding Precautions .....	54
Starting & Stopping the Engine .....	55
Preparation.....	55
Starting Procedure .....	56
Flooded Engine.....	59
Bank Angle Sensor Ignition Cut-off System.....	59
How to Stop the Engine .....	60
Riding.....	61
Braking .....	68
Parking .....	72
Riding with a Passenger or Cargo.....	76

## Safe Riding Precautions

---

Before riding your scooter for the first time, please review the *Scooter Safety* section beginning on page 1, and the *Before Riding* section beginning on page 35 .

Even if you have ridden other scooters, take time to become familiar with how this scooter works and handles. Practice in a safe area until you build your skills and get accustomed to the scooter's size and weight.

Make sure flammable materials such as dry grass or leaves do not come in contact with the exhaust system when riding, idling, or parking your scooter.

## Starting & Stopping the Engine

---

Always follow the proper starting procedure described below.

For your safety, avoid starting or operating the engine in an enclosed area such as a garage. Your scooter's exhaust contains poisonous carbon monoxide gas which can collect rapidly in an enclosed area and cause illness or death.

Your scooter is equipped with a side stand ignition cut-off system. If the side stand is down—the engine cannot be started.

Do not use the electric starter for more than 5 seconds at a time. Release the start button for approximately 10 seconds before pressing it again.

Operate the starter button for slightly longer than usual without opening the throttle if the scooter has been left standing for a long time or when the fuel tank has just been refilled.

### Preparation

Before starting, insert the key, turn the ignition switch ON, and confirm the following:

- The engine stop switch is set to RUN.
- The low oil pressure indicator is ON.
- The PGM-FI malfunction indicator lamp (MIL) is OFF.
- The coolant temperature indicator is OFF.
- The V-matic indicator is OFF.



# Starting & Stopping the Engine

---

## Starting Procedure

This scooter has a fuel-injected engine with an automatic fast idle. Follow the procedure indicated below.

### Any Air Temperature

1. Place the scooter on its center stand.

2. Lock the rear wheel by squeezing the rear brake lever (1) and setting the parking brake lever (2).

## CAUTION

Contact with the spinning rear wheel can cause you to be hurt.

Set the parking brake when the scooter is on its center stand.

The electric starter will only work when the rear brake lever is pulled in and the side stand is up.

# Starting & Stopping the Engine

## LEFT HANDLEBAR

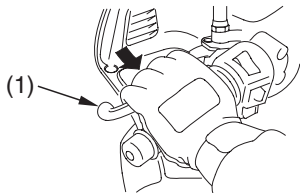

(1) rear brake lever

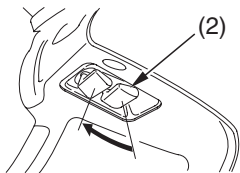

(2) parking brake lever

3. Make sure the engine stop switch is at RUN.
4. Turn the ignition switch (3) ON.

The low oil pressure indicator should go off a few seconds after the engine starts. If the low oil pressure indicator lights during operation, stop the engine immediately and check the engine oil level.

## BELOW HANDLEBAR

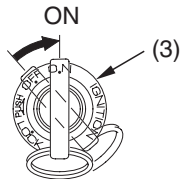

(3) ignition switch

(cont'd)

## Starting & Stopping the Engine

---

5. With the throttle closed, push the start button (4). Release the start button as soon as the engine starts.

The engine will not start if the throttle is opened by more than 30% (because the electronic control module cuts off the fuel supply).

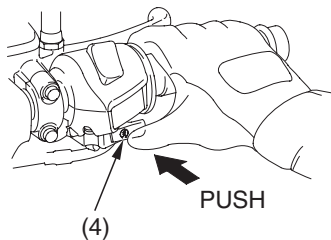

(4) start button

6. Be sure to keep the throttle (5) closed and the parking brake locked while starting and warming up the engine.
7. Allow the engine to warm up before riding (see *Riding*, page 61 ).

Do not “blip” (rapidly open and close) the throttle. This action may cause the scooter to move forward suddenly.

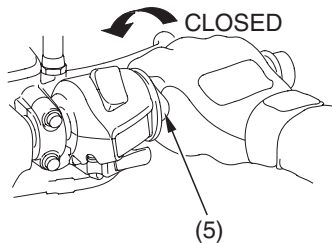

(5) throttle

# Starting & Stopping the Engine

---

## Flooded Engine

If the engine fails to start after repeated attempts, it may be flooded with excess fuel. To clear a flooded engine:

1. Leave the engine stop switch set to RUN.
2. Open the throttle fully.
3. Press the start button for 5 seconds.
4. Follow the normal starting procedure.
5. If the engine starts, then open the throttle slightly if idling is unstable. If the engine does not start, wait 10 seconds, then follow steps 1 – 4 again.

If the engine still won't start, refer to *If Your Engine Quits or Won't Start*, page 171 .

## Bank Angle Sensor Ignition Cut-off System

Your scooter's banking (lean angle) sensor system is designed to automatically stop the engine and fuel pump if the scooter is overturned.

Before restarting the engine, you must turn the ignition switch to the OFF position and then back to ON. The engine will not restart until you perform this procedure.

# Starting & Stopping the Engine

---

## How to Stop the Engine

### Normal Engine Stop

To stop the engine, turn the ignition switch OFF.

The engine stop switch should normally remain in the RUN position even when the engine is OFF.

If your scooter is stopped with the engine stop switch OFF and the ignition switch ON, the headlight and taillight will remain on, resulting in battery discharge.

### Emergency Engine Stop

To stop the engine in an emergency, use the engine stop switch. To operate, press the switch to the OFF position.

1. To prevent unexpected movement, make sure the throttle is closed and the parking brake is locked (page 32 ) before moving the scooter off its center stand.

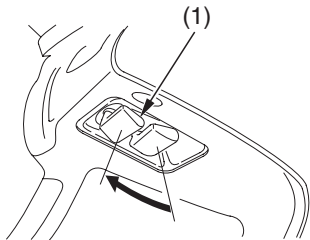

(1) parking brake lever

2. Stand on the left side of the scooter and push it forward and off the center stand.

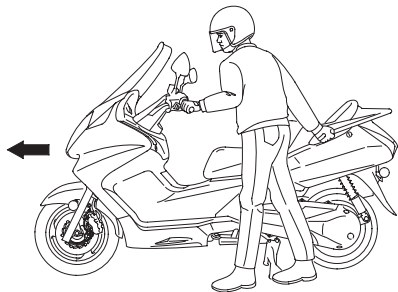

(cont'd)

# Riding

---

3. Mount the scooter from the left side, keeping at least one foot on the ground to steady the scooter.

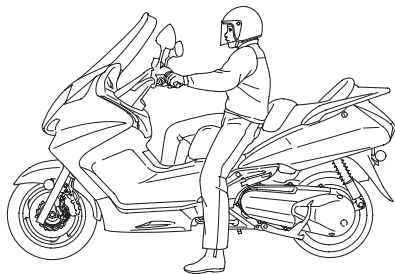

4. To unlock the rear wheel, release the parking brake lever (1).

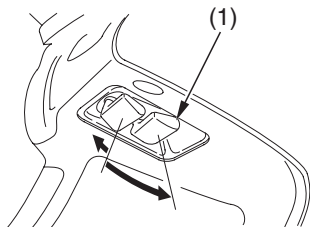

(1) parking brake lever

5. Before starting off, indicate your direction with the turn signals, and check for safe traffic conditions. Grasp the handlebars firmly with both hands.

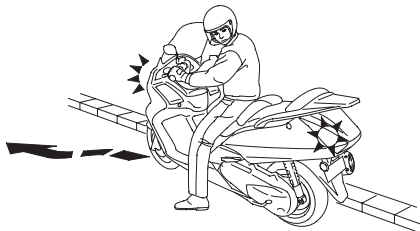

6. To accelerate, open the throttle (2) gradually. The scooter will move forward.

Do not blip (rapidly open and close) the throttle as the scooter will move forward suddenly.

7. To decelerate, close the throttle.

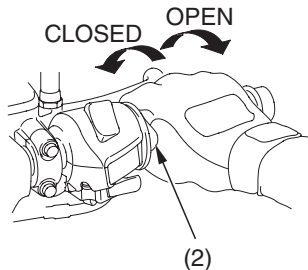

(2) throttle

(cont'd)



# Riding

---

8. To slow the scooter, reduce the throttle (2) and apply the front (3) and rear (4) brakes together.

Using only one brake reduces stopping performance. Excessive brake application may cause either wheel to lock, reducing control of the scooter.

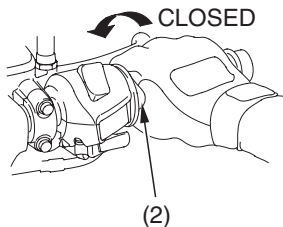

(2) throttle

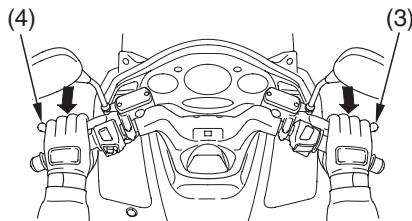

(3) front brake lever

(4) rear brake lever

9. When approaching a corner or turn, slow the scooter by closing the throttle (2) fully and applying both the front (3) and rear (4) brakes at the same time.

10. After completing a turn, open the throttle gradually to accelerate the scooter.

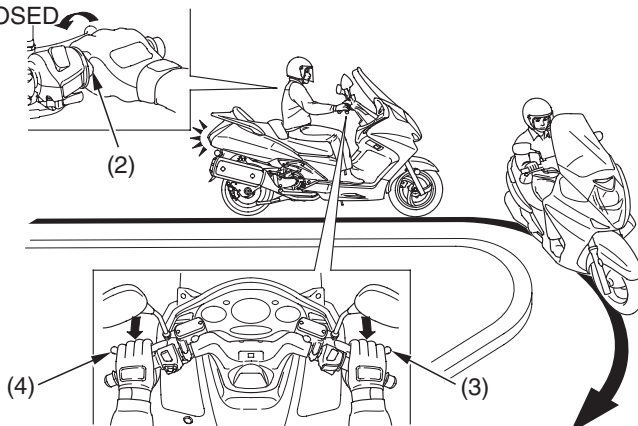

(2) throttle

(3) front brake lever

(4) rear brake lever

(cont'd)

# Riding

---

11. When descending a steep grade, close the throttle ( 2 ) fully and apply both the front ( 3 ) and rear ( 4 ) brakes to slow the scooter.

Avoid continued use of the brakes, which may cause the brakes to overheat and reduce braking efficiency.

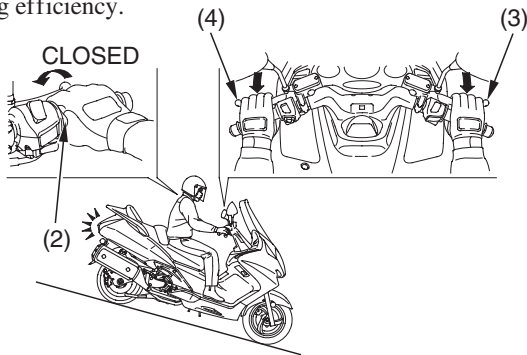

(2) throttle

(3) front brake lever

(4) rear brake lever

12. When riding in wet or rainy conditions or loose surfaces, the ability to maneuver and stop is reduced. For your safety:
- Exercise extreme caution when braking, accelerating, or turning.
  - Ride at slower speeds and allow for extra stopping distance.
  - Keep the scooter as upright as possible.
  - Use extreme caution when riding over slippery surface such as railroad tracks, iron plates, manhole covers, painted lines, etc.

# Braking

---

Your scooter is equipped with a Combined Braking System. Operating the front brake lever applies the front brake. Operating the rear brake lever applies the rear brake and a portion of the front brake. For full braking effectiveness, use the front and rear brake levers simultaneously.

## FSC600A only:

This model is also equipped with an Anti-Lock Brake System (page 70 ).

## FSC600D only:

This model is not equipped with an Anti-Lock Brake System. As with a conventional scooter braking system, excessively hard application of the brake controls may cause wheel lock, reducing control of the scooter.

To slow or stop, apply the front and rear brake levers smoothly.

Gradually increase braking as you feel the brakes slowing your speed.

For support, before coming to a complete stop, put your left foot down first, then your right foot down.

Applying the brakes too hard may cause the wheels to lock and slide, reducing control of your scooter. If this happens, release the brake controls, steer straight ahead until you regain control, then reapply the brakes more gently.

When possible, reduce your speed or complete braking before entering a turn. Avoid braking or closing the throttle quickly while turning. Either action may cause one or both wheels to slip and reduce your control of your scooter.

Your ability to brake in a turn and to brake hard in an emergency situation are important riding skills. We suggest attending a Motorcycle Safety Foundation experienced rider training course (page 38 ) to retain these skills.

When riding in wet or rainy conditions, or on loose surfaces, the ability to maneuver and stop will be reduced. All of your actions should be smooth under these conditions. Rapid acceleration, braking or turning may cause loss of control. For

your safety, exercise extreme caution when braking, accelerating or turning.

When descending a long, steep grade, use both brakes intermittently. Continuous brake application can overheat the brakes and reduce their effectiveness.

Riding with your hand on either brake lever may actuate the brakelight, giving a false indication to other drivers. It may also overheat the brakes, reducing effectiveness.

# Braking

---

## Anti-Lock Brake System (ABS)

FSC600A only:

This model is also equipped with an Anti-lock Brake System (ABS) designed to help prevent wheel lock up during hard braking on uneven or other poor surfaces while running straight. Although the wheel may not lock up—if you are braking too hard in a turn the scooter can still lose traction, causing a loss of control.

In some situations, a scooter with ABS may require a longer stopping distance to stop on loose or uneven surfaces than an equivalent scooter without ABS.

ABS cannot make up for road conditions, bad judgment, or improper operation of

the brakes. It is still your responsibility to ride at reasonable speeds for weather, road surface, and traffic conditions, and to leave a margin of safety.

ABS is self-checking and always on.

ABS may be activated by riding over a sharp drop or rise in the road level.

It is important to follow the tire recommendations (page 147 ). The ABS computer works by comparing wheel speed. Non-recommended tires can affect wheel speed and may confuse the ABS computer.

ABS does not function at low speeds (approximately 6 mph (10km/h) or below). ABS does not function if the battery is discharged.

### ABS Indicator Light

#### FSC600A only:

Normally, this light comes on when the ignition is turned ON, and goes off after you ride the scooter at speed above 6 mph (10 km/h). If there is an ABS problem, the indicator light comes on and remains on. The ABS system does not operate when the ABS indicator light is on.

If the ABS indicator light comes on while riding, stop the scooter in a safe place and turn off the engine.

Turn the ignition ON again. The light should come on, and go off after you ride the scooter at speeds above 6 mph (10 km/h). If it does not go off, ABS is not functioning, but the brakes still work the Combined Brake System and provide normal stopping ability. However, you should have the system checked by Honda dealer as soon as possible.

The ABS indicator light may come on if you turn the rear wheel at high speed for more than 30 seconds while the scooter is upright on the stand. This is normal. Turn the ignition OFF, then turn it ON. The indicator should come on, then go off after you run the scooter above 19 mph (30 km/h).



# Parking

---

1. Look for a level parking area. If you can't park on a paved surface, make sure the ground surface is firm, especially under the center stand. Make sure flammable materials such as dry grass or leaves do not come in contact with the exhaust system when parking your scooter. Refer to *Catalytic Converter*, page 208.

If you must park on a hill, position the rear tire against the curb at a 45 degree angle.

2. Use the side or center stand to support the scooter while parked.
  - To lower the side stand, use your foot to guide it down.
  - Check that the side stand is down all the way so that the side stand ignition cut-off system (page 55 ) is activated.

- To lower the center stand, stand on the left side of the scooter. Hold the left handle grip and the left passenger handrail. Press down on the tip of the stand with your right foot and, simultaneously, pull up and back.
- If you have to park on a soft surface, insert something solid under the stand for support.

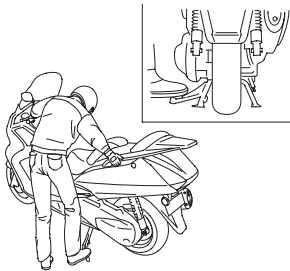

USE CENTER STAND

3. Use the steering lock, which locks the handlebar in place. Turn the handlebar all the way to the left or right. Push in on the ignition key (1) and turn it to LOCK. Remove the key.  
(To unlock the steering lock, insert and push down on the key and turn it to the right to the OFF position.)

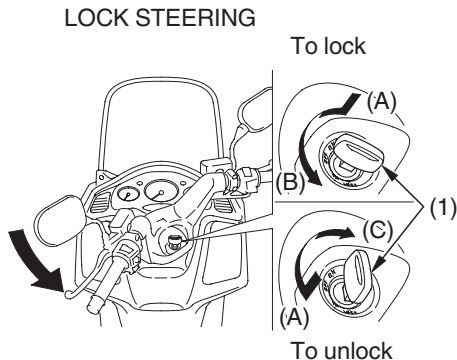

(1) ignition key

(A) push in

(B) turn to LOCK

(C) turn to OFF

(cont'd)

## Parking

---

4. Use the helmet holder to secure your helmet with your scooter:
- Open the seat (page 47 ).
  - Hang your helmet on the holder hook (2).
  - Close the seat. Check that it is locked.

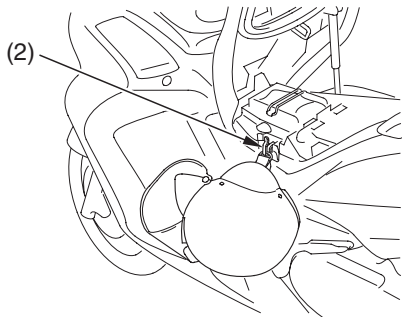

(2) holder hook

### Theft-Prevention Tips

- Park your scooter in a locked garage whenever possible. If a garage isn't available, park in a concealed area or in a well-lit area with enough pedestrian traffic to discourage a thief.
  - Always take the ignition key with you.
  - Always use the steering lock (page 73 ), even if you're parking for just a minute or two. A thief can easily push an unlocked scooter to a waiting truck.
  - In addition to the steering lock, use a good quality anti-theft device made specifically to lock a scooter to a secure object.
- If you decide to use an anti-theft device, select one of good quality and be sure to follow the manufacturer's instructions.
  - Keep your owner's manual, current registration, and insurance information with your scooter. This will make it easier for the authorities to find you if your scooter is stolen and recovered.

## Riding with a Passenger or Cargo

---

Your scooter is designed to carry you and one passenger. Whenever you add a passenger or cargo, you must be careful not to exceed the total load limits for this vehicle (*Load Limits*, page 44). Make sure your cargo is properly secured (*Loading Guidelines*, page 45).

Be aware that carrying a passenger or heavy cargo can affect acceleration, braking, and handling.

Before riding with a passenger, make sure your passenger is wearing the proper protective apparel (page 36 ).

Tell your passenger to hold the passenger handrails or your waist, lean with you in the turns, and keep their feet on the passenger footpegs at all times, even when the scooter is stopped at a traffic light.

## Servicing Your Honda

---

To help keep your scooter in good shape, this section includes a Maintenance Schedule for required service, a list of periodic checks you should perform at least once a month, and step-by-step instructions for specific maintenance tasks. You'll also find important safety precautions, information on fuels and oils, and tips for keeping your Honda looking great.

For information about the exhaust emission and noise emission requirements of the U.S. Environmental Protection Agency (EPA) and the California Air Resources Board (CARB), see page 202 .

For information about replacing fuses, see page 183 .

USA only:

**Maintenance, replacement or repair of the emission control devices and systems may be performed by any motorcycle repair establishment or individual using parts that are “certified” to EPA standards.**

### *Before You Service Your Honda*

The Importance of Maintenance .....	80
Maintenance Safety .....	81
Important Safety Precautions .....	82
Periodic Maintenance .....	84
Maintenance Schedule .....	86
Maintenance Record .....	91

(cont'd)

# Servicing Your Honda

---

## *Service Preparations*

Component Locations .....	93
Tool Kit.....	96
Owner's Manual Storage.....	97
Rear Cover Removal .....	98
Left Side Cover Removal.....	99
Right Side Cover Removal .....	101
Right Fairing Compartment Removal.....	103

## *Service Procedures*

### Fluids & Filters

Fuel .....	104
Engine Oil, Filter & Strainer Screen....	108
Coolant.....	118
Air Cleaner .....	122
Crankcase Breather .....	124

### Engine

Throttle .....	125
Engine Idle Speed.....	127
Spark Plug.....	129

### Chassis

Suspension .....	132
Brakes .....	135
Tires .....	142
Side Stand .....	149

### Electrical

Battery.....	150
--------------	-----

Appearance Care .....	155
-----------------------	-----

## Servicing Your Honda

---

The following table summarizes the three types of inspections and servicing recommendations for your scooter. Both the pre-ride inspection and the scheduled maintenance at the recommended intervals are necessary to assure safe and dependable performance. The periodic checks provide additional confidence in your scooter's performance.

Type of Inspection/Service	Refer to page:	When Performed	Who Performs
Pre-ride Inspection	40	before every ride	you
Periodic Maintenance	84	monthly*	you
Maintenance Schedule	86	interval on schedule	your Honda dealer**

\* more often if you ride frequently or long distances; or anytime you clean your scooter

\*\* unless you have the proper tools and service data and are mechanically qualified



## The Importance of Maintenance

---

Keeping your scooter well-maintained is absolutely essential to your safety. It's also a good way to protect your investment, get maximum performance, avoid breakdowns, and have more fun. A properly maintained scooter will also help to reduce air pollution.

Remember, proper maintenance is the owner's responsibility. Be sure to inspect your scooter before each ride, perform the periodic checks, and follow the Maintenance Schedule in this section.

### **WARNING**

Improperly maintaining this scooter or failing to correct a problem before you ride can cause a crash in which you can be seriously hurt or killed.

Always follow the inspection and maintenance recommendations and schedules in this owner's manual.

If your scooter overturns or is involved in a crash, be sure your Honda dealer inspects all major parts, even if you are able to make some repairs.

## Maintenance Safety

---

This section includes instructions on how to perform some important maintenance tasks. If you have basic mechanical skills, you can perform many of these tasks with the tools provided with your scooter.

Other tasks that are more difficult and require special tools are best performed by professionals. Wheel removal should normally be handled only by a Honda technician or other qualified mechanic. Instructions are included in this manual only to assist in emergency service.

Some of the most important safety precautions follow. However, we cannot warn you of every conceivable hazard that can arise in performing maintenance. Only you can decide whether or not you should perform a given task.

### **WARNING**

Failure to properly follow maintenance instructions and precautions can cause you to be seriously hurt or killed.

Always follow the procedures and precautions in this owner's manual.

# Maintenance Safety

---

## Important Safety Precautions

- Make sure the engine is off before you begin any maintenance or repairs. This will help eliminate several potential hazards:

**Carbon monoxide poisoning from engine exhaust.** Be sure there is adequate ventilation whenever you operate the engine.

**Burns from hot scooter parts.** Let the engine and exhaust system cool before touching.

**Injury from moving parts.** Do not run the engine unless instructed to do so.

- Read the instructions before you begin, and make sure you have the tools and skills required.
- To help prevent the scooter from falling over, park it on a firm, level surface, using the side stand or a maintenance stand to provide support.
- Be sure the rear brake lock is set before running the engine while the scooter is supported by the center stand. This will prevent the rear wheel from spinning and avoid the possibility of someone being injured from contacting the wheel.
- To reduce the possibility of a fire or explosion, be careful when working around gasoline. Use only non-flammable solvent, not gasoline, to clean parts. Keep cigarettes, sparks, and flames away from all fuel-related parts.

Remember that your Honda dealer knows your scooter best and is fully equipped to maintain and repair it. To ensure the best quality and reliability, use only new genuine Honda parts or their equivalents for repair and replacement. If you have the tools and skills required for additional maintenance jobs, you can purchase an official Honda Service Manual (page 212 ).

## Periodic Maintenance

---

In addition to the regularly scheduled maintenance (page 86 ) and daily pre-ride inspection (page 40 ), consider performing the periodic checks on the following page at least once a month, even if you haven't ridden your scooter, or as often as once a week if you ride frequently or for long distances. It's a good idea to perform this maintenance any time you clean your scooter.

Check the odometer reading and perform any scheduled maintenance checks that are needed (page 86 ). Remember, more frequent checks may be needed for riding in severe conditions.

## Periodic Maintenance

<i>Tires &amp; Wheels</i>	Check the air pressure with a gauge and add air if needed (page 142 ). Examine the tread for wear (page 144 ). Look closely for nails, embedded objects, cuts, and other types of damage (page 144 ). Roll your scooter so you can inspect the entire surface. Check the condition of the wheels.
Fluids	Check the levels of the engine oil (page 112 ), coolant (page 119 ), and brake fluid (page 136 ). Add the correct fluid as necessary, and investigate the cause of any low fluid level.
Lights	Make sure the headlight, brake light, taillight, and turn signals are working properly.
Freeplay	Check the freeplay of the parking brake lever (page 141 ), and throttle grip.
Fuses	Make sure you have a full supply of spare fuses.
Nuts & Bolts	Check the major fasteners and tighten as needed.

## Maintenance Schedule

---

The required Maintenance Schedule that follows specifies how often you should have your scooter serviced, and what things need attention. It is essential to have your scooter serviced as scheduled to maintain safe, dependable performance and proper emission control.

The service intervals in this Maintenance Schedule are based on average riding conditions. Some items will need more frequent service if you ride in unusually wet or dusty areas or at full throttle. Consult your Honda dealer for recommendations applicable to your individual needs and use.

Some items in the Maintenance Schedule can be performed with basic mechanical skills and hand tools. Procedures for these items are provided in this manual. Other items involve more extensive procedures and may require special training, tools, and equipment. We recommend that you have your Honda dealer perform these tasks unless you have advanced mechanical skills and the required tools and equipment. Procedures for such items in this schedule are provided in an official Honda Service Manual available for purchase (page 212).

## Maintenance Schedule

---

If you do not feel capable of performing a given task or need assistance, remember that your Honda dealer knows your scooter best and is fully equipped to maintain and repair it. If you decide to do your own maintenance, use only genuine Honda parts or their equivalents for repair or replacement to ensure the best quality and reliability.

Perform the pre-ride inspection (page 40 ) and owner maintenance (page 88 ) at each scheduled maintenance period.

Each item on the maintenance schedule requires some mechanical knowledge. Certain items (particularly those marked \* and \*\*) may require more technical information and tools. Consult your Honda dealer.

\* Should be serviced by your Honda dealer, unless you have the proper tools and service data and are mechanically qualified. Refer to the official Honda Service Manual (page 212 ).

\*\* In the interest of safety, we recommend these items be serviced only by your Honda dealer.



# Maintenance Schedule

---

## *Summary of Maintenance Schedule Notes & Procedures:*

### NOTES:

1. At higher odometer readings, repeat at the frequency interval established here.
2. Service more frequently if the scooter is ridden in unusually wet or dusty areas.
3. Service more frequently if the scooter is ridden often at full throttle or in the rain.
4. Inspect every 12,000 mi (19,200 km) after replacement.
5. Replace every 2 years, or at indicated odometer interval, whichever comes first. Replacement requires mechanical skill. Refer to the official Honda service manual.
6. Replace every 2 years.  
Replacement requires mechanical skill.

### Maintenance Procedures:

I: inspect and clean, adjust, lubricate, or replace, if necessary

C: clean

A: adjust

L: lubricate

R: replace

# Maintenance Schedule

			FREQUENCY		ODOMETER READING (Note 1)								Refer to page
					× 1,000 mi	0.6	4	8	12	16	20	24	
ITEM		NOTE	× 1,000 km	1.0	6.4	12.8	19.2	25.6	32.0	38.4			
EMISSION RELATED ITEMS	*	FUEL LINE				I		I		I	—		
	*	THROTTLE OPERATION				I		I		I	—		
		AIR CLEANER	2					R			R	122	
		CRANK CASE BREATHER	3			C	C	C	C	C	C	124	
		SPARK PLUG					R		R		R	129	
	*	VALVE CLEARANCE							I			—	
		ENGINE OIL				R		R		R		R	108
		ENGINE OIL FILTER				R		R		R		R	113
	*	ENGINE OIL STRAINER SCREEN					C		C		C	113	
	*	ENGINE IDLE SPEED				I	I	I	I	I	I	I	127
		RADIATOR COOLANT	5				I		I		R	118	
	*	COOLING SYSTEM					I		I		I	—	
	*	SECONDARY AIR SUPPLY SYSTEM					I		I		I	—	
	*	EVAPORATIVE EMISSION CONTROL SYSTEM						I			I	—	

\* Should be serviced by your Honda dealer, unless you have the proper tools and service data and are mechanically qualified. Refer to the official Honda Service Manual (page 212 ).

# Maintenance Schedule

ITEM		FREQUENCY	NOTE	ODOMETER READING (Note 1)								Refer to page	
				× 1,000 mi	0.6	4	8	12	16	20	24		
				× 1,000 km	1.0	6.4	12.8	19.2	25.6	32.0	38.4		
NON-EMISSION RELATED ITEMS	*	DRIVE BELT	4					I	R			—	
	*	BELT CASE AIR CLEANER					C		C		C	—	
	*	FINAL DRIVE OIL	6									—	
		BRAKE FLUID	5				I	I	R	I	I	R	136
		BRAKE PADS WEAR					I	I	I	I	I	I	139
		BRAKE SYSTEM					I		I			I	135
	*	BRAKE LOCK OPERATION					I	I	I	I	I	I	32
	*	HEADLIGHT AIM						I		I		I	—
	**	CLUTCH SHOES WEAR					I	I	I	I	I	I	—
		SIDE STAND						I		I		I	149
	*	SUSPENSION						I		I		I	—
	*	NUTS, BOLTS, FASTENERS					I		I			I	—
	**	WHEELS/TIRES						I		I		I	—
	**	STEERING HEAD BEARINGS					I		I			I	—

\* Should be serviced by your Honda dealer, unless you have the proper tools and service data and are mechanically qualified. Refer to the official Honda Service Manual (page 212 ).

\*\* In the interest of safety, we recommend these items be serviced only by your Honda dealer.

## Maintenance Record

---

Keeping an accurate maintenance record will help ensure that your scooter is properly maintained. Retain detailed receipts to verify the maintenance was performed. If the scooter is sold, these receipts should be transferred with the scooter to the new owner. Make sure whoever performs the maintenance completes this record. All scheduled maintenance, including the 600 mile (1,000 km) initial maintenance, is considered a normal owner operating cost and will be charged for by your dealer. Use the space under Notes to record anything you want to remind yourself about or mention to your dealer.

<b>Miles (km)</b>	<b>Odometer</b>	<b>Date</b>	<b>Performed By:</b>	<b>Notes</b>
600 (1,000)				
4,000 (6,400)				
8,000 (12,800)				
12,000 (19,200)				
16,000 (25,600)				
20,000 (32,000)				

## Maintenance Record

---

<b>Miles (km)</b>	<b>Odometer</b>	<b>Date</b>	<b>Performed By:</b>	<b>Notes</b>
24,000 (38,400)				
28,000 (44,800)				
32,000 (51,200)				
36,000 (57,600)				
40,000 (64,000)				
44,000 (70,400)				
48,000 (76,800)				
52,000 (83,200)				
56,000 (89,600)				
60,000 (96,000)				
64,000 (102,400)				
68,000 (108,800)				

## Component Locations

---

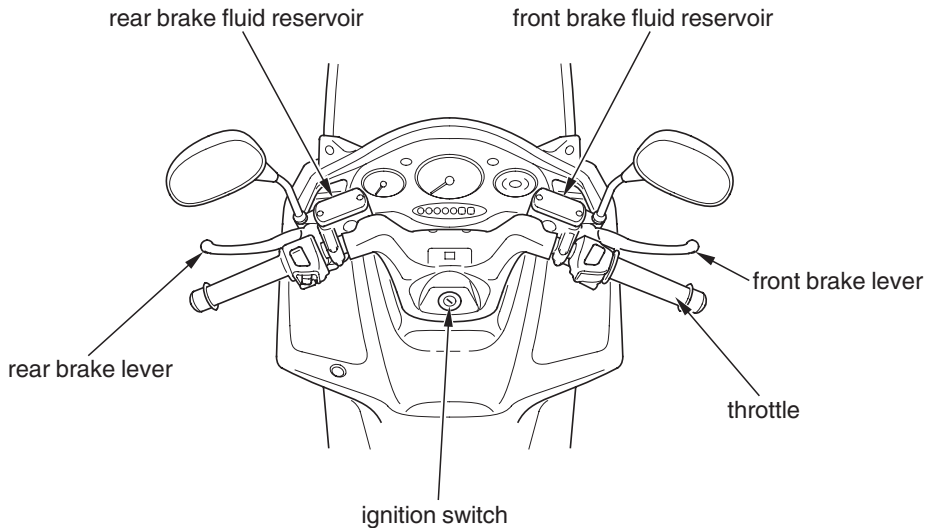

# Component Locations

---

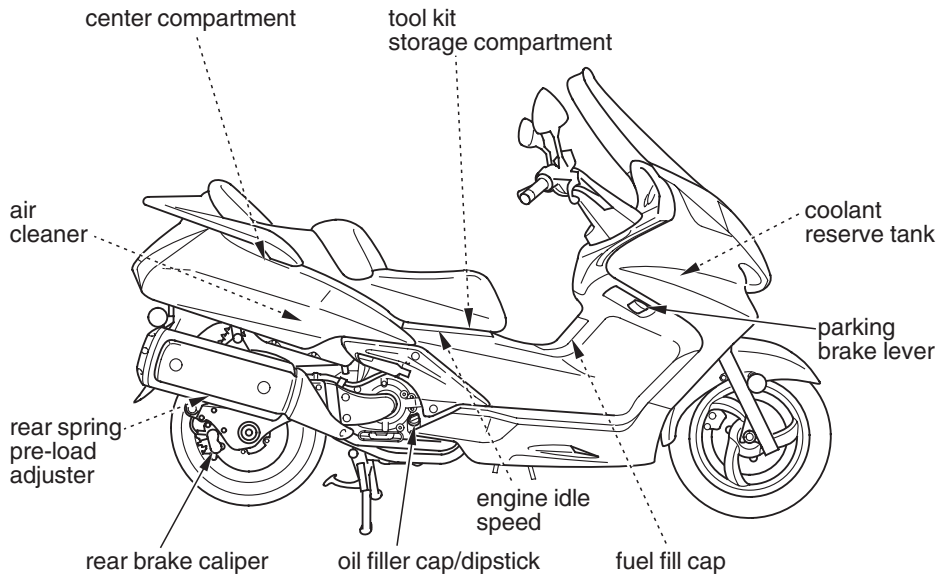

## Component Locations

---

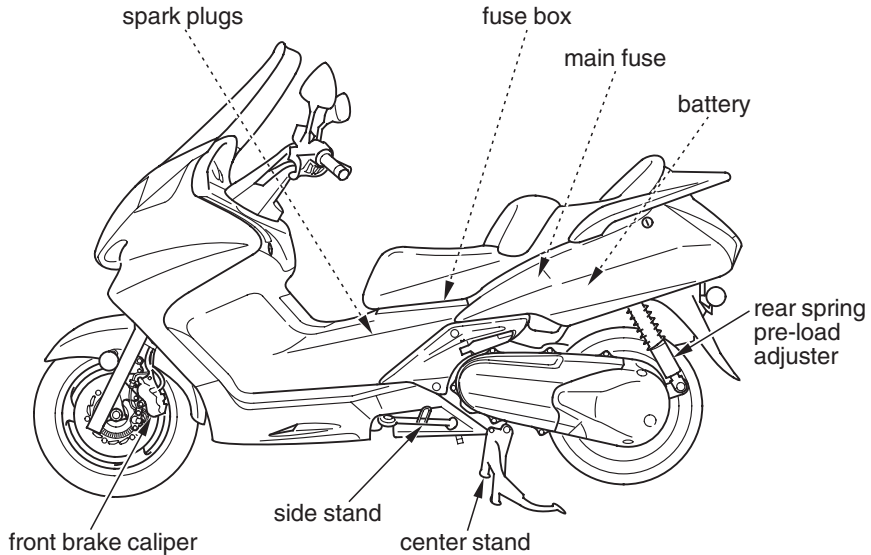



## Tool Kit

---

The tool kit (1) is stored in the storage compartment (2) under the seat (page 47 ). Some roadside repairs, minor adjustments, and parts replacement can be performed with the tools contained in the kit.

### UNDER SEAT

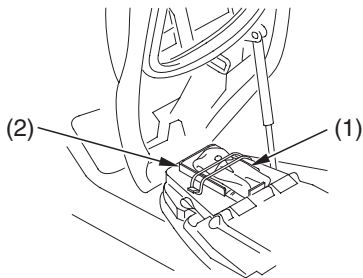

(1) tool kit      (2) storage compartment

- 10 × 12 mm box end wrench
- 14 × 17 mm open end wrench
- no. 2 Phillips screwdriver
- no. 2 screwdriver
- screwdriver handle
- 5 mm hex wrench
- pin spanner
- spark plug wrench
- tool bag

## Owner's Manual Storage

Your scooter provides storage for the owner's manual so you'll have it with you for easy reference. Store your owner's manual (and other documents) in the plastic storage bag (1) in the storage compartment (2) under the seat.

Be careful not to flood this area when washing your scooter.

### UNDER SEAT

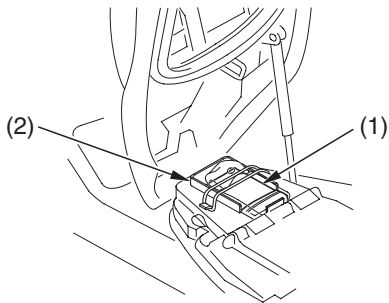

- (1) storage bag
- (2) storage compartment

## Rear Cover Removal

---

Refer to *Safety Precautions* on page 82 .

The rear cover must be removed to remove the left and right side cover.

### Removal

1. Remove the screws (1).
2. Remove the rear cover (2).

### Installation

- Installation can be done in the reverse order of removal.

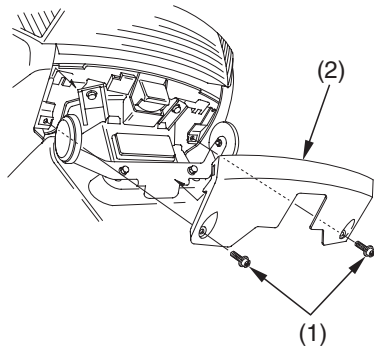

(1) screws

(2) rear cover

## Left Side Cover Removal

Refer to *Safety Precautions* on page 82 .

The left side cover must be removed to service the main fuse.

### Removal

1. Remove the rear cover (page 98).
2. Open the seat (page 47).
3. Remove the A screws (1) and B screw (2).

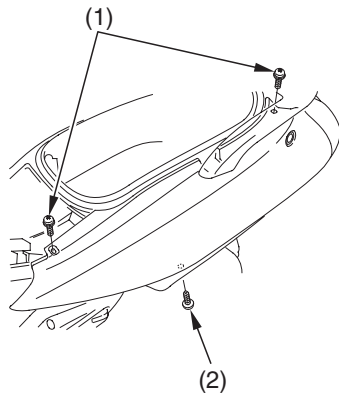

(1) A screws

(2) B screw

(cont'd)

## Left Side Cover Removal

---

4. Remove the A hook (3) from the side of turn signal light case (4).
5. Remove the B hooks (5) from the B slots (6).
6. Remove the prongs (7) from the grommets (8).
7. Remove the C hooks (9) from the C slots (10).

### Installation

- Installation can be done in the reverse order of removal.

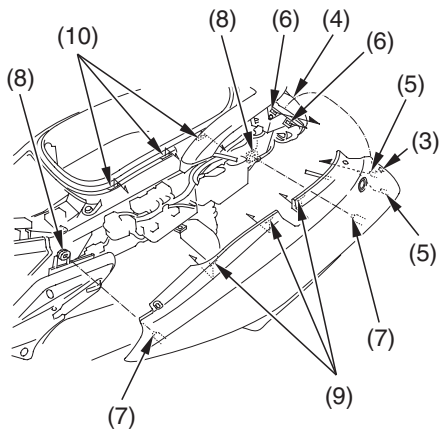

- |                            |              |
|----------------------------|--------------|
| (3) A hook                 | (7) prongs   |
| (4) turn signal light case | (8) grommets |
| (5) B hooks                | (9) C hooks  |
| (6) B slots                | (10) C slots |

## Right Side Cover Removal

Refer to *Safety Precautions* on page 82 .

The right side cover must be removed to service the air cleaner.

### Removal

1. Remove the rear cover (page 98).
2. Open the seat (page 47).
3. Remove the A screws (1).

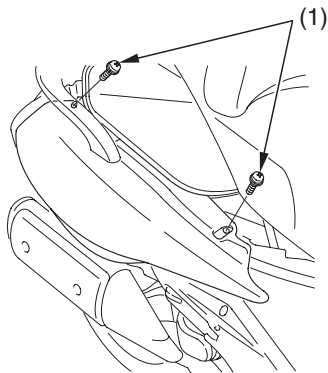

(1) A screws

(cont'd)

## Right Side Cover Removal

4. Remove the A hook (2) from the side of turn signal light case (3).
5. Remove the B hooks (4) from the B slots (5).
6. Remove the prongs (6) from the grommets (7).
7. Remove the C hooks (8) from the C slots (9).

### Installation

- Installation can be done in the reverse order of removal.

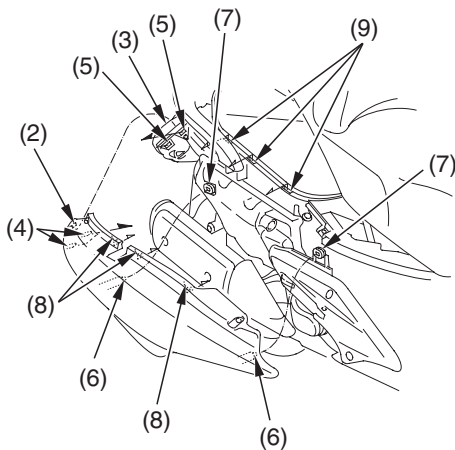

- |                            |              |
|----------------------------|--------------|
| (2) A hook                 | (6) prongs   |
| (3) turn signal light case | (7) grommets |
| (4) B hooks                | (8) C hooks  |
| (5) B slots                | (9) C slots  |

# Right Fairing Compartment Removal

Refer to *Safety Precautions* on page 82 .

The right fairing compartment must be removed to access the coolant reserve tank.

## RIGHT SIDE

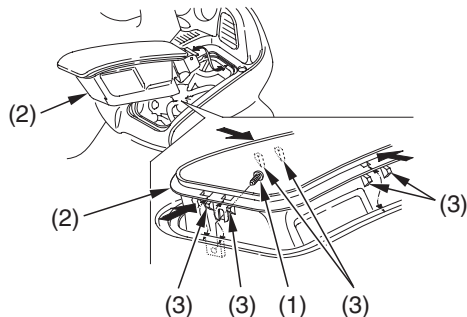

- (1) screw
- (2) right fairing compartment
- (3) hooks

## Removal

1. Open the right fairing compartment cover (page 50).
2. Remove the screw (1).
3. Pry up on the edge of the right fairing compartment (2) to release the right, left and rear hooks (3) as shown.
4. Close the right fairing compartment cover.
5. Remove the right fairing compartment by pulling it toward you.

## Installation

- Installation can be done in the reverse order of removal.



# Fuel

---

Refer to *Safety Precautions* on page 82 .

## Fuel Recommendation

type	unleaded
pump octane number	86 (or higher)

We recommend that you use unleaded fuel because it produces fewer engine deposits and extends the life of exhaust system components.

The use of leaded gas will damage the catalytic converter.

Your engine is designed to use any gasoline that has a pump octane number of 86 or higher. Gasoline pumps at service stations normally display the pump octane number. For information on the use of oxygenated fuels, see page 209 .

Use of lower octane gasoline can cause persistent “pinging” or “spark knock” (a loud rapping noise) which, if severe, can lead to engine damage. Light pinging experienced while operating under a heavy load, such as climbing a hill, is no cause for concern.

If pinging or spark knock occurs at a steady engine speed under normal load, change brands of gasoline. If pinging or spark knock persists, consult your Honda dealer.

Never use stale or contaminated gasoline or an oil/gasoline mixture. Avoid getting dirt, dust, or water in the fuel tank.

# Fuel

## Fuel Capacity

Fuel tank capacity:  
4.23 US gal (16.0 ℓ)

The tank should be refilled as soon as possible when the E segment in the fuel gauge flashes.

## Refueling Procedure

Refer to *Safety Precautions* on page 82 .

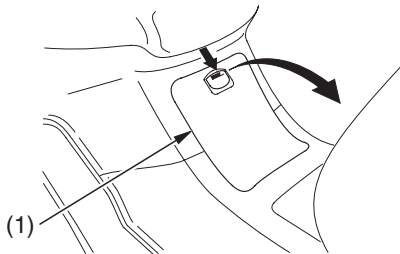

(1) fuel tank lid

1. Open the fuel tank lid ( 1 ).

2. Insert the ignition key (2) in the fuel fill cap (3) and turn it clockwise.
3. Remove the fuel fill cap by turning it counterclockwise.
4. Add fuel until the level reaches the bottom of the filler neck (4). Avoid overfilling the tank. There should be no fuel in the filler neck.

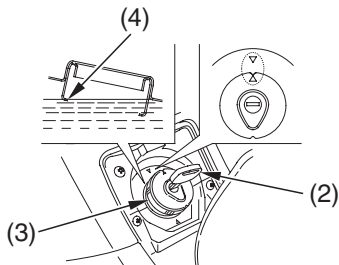

(2) ignition key  
(3) fuel fill cap

(4) filler neck

## **⚠ WARNING**

Gasoline is highly flammable and explosive. You can be burned or seriously injured when handling fuel.

- Stop the engine and keep heat, sparks and flame away.
- Handle fuel only outdoors.
- Wipe up spills immediately.

5. After refueling, install the fuel fill cap by turning it clockwise.
6. Turn the ignition key counterclockwise and remove it.
7. Close the fuel tank lid.

## Engine Oil, Filter & Strainer Screen

---

Engine oil quality is a major factor that affects both the performance and the service life of the engine.

Using the proper oil (page 109 ) and filter, and regularly checking, adding, and changing oil will help extend your engine's life. Even the best oil wears out. Changing oil helps get rid of dirt and deposits in the engine. Operating the engine with old or dirty oil can damage your engine. Running the engine with insufficient oil can cause serious damage to the engine.

Change the engine oil as specified in the maintenance schedule on page 89 .

When running in very dusty conditions, oil changes should be performed more frequently than specified in the maintenance schedule.

## Engine Oil, Filter & Strainer Screen

### Oil Recommendation

API classification	SG or higher except oils labeled as energy conserving on the circular API service label
viscosity (weight)	SAE 10W-40
JASO T 903 standard	MA or MB

#### suggested oil\*

Pro Honda GN4, HP4 (without molybdenum additives), or HP4M (with molybdenum additives) 4-stroke oil, or an equivalent motorcycle oil.

- \* Suggested oils are equal in performance to SJ oils that are not labeled as energy conserving on the circular API service label.

## Engine Oil, Filter & Strainer Screen

- Your scooter does not need oil additives. Use the recommended oil.
- Do not use API SH or higher oils displaying a circular API “energy conserving” service label on the container. They may affect lubrication and clutch performance.



NOT RECOMMENDED



OK

- Do not use non-detergent, vegetable, or castor based racing oils.

Other viscosities shown in the following chart may be used when the average temperature in your riding area is within the indicated range.

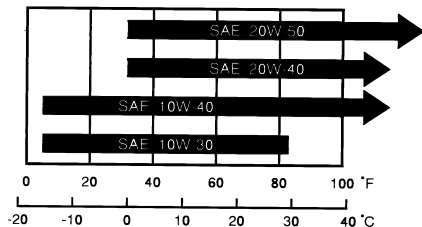

## Engine Oil, Filter & Strainer Screen

---

### JASO T 903 standard

The JASO T 903 standard is an index to choose engine oils for 4-stroke motorcycle engines.

There are two classes: MA and MB.

Oil conforming to the standard has the following classification on the oil container.

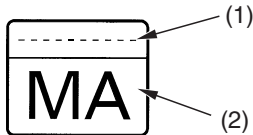

PRODUCT MEETING JASO T 903  
COMPANY GUARANTEEING THIS MA PERFORMANCE:

- (1) code number of the sales company of the oil
- (2) oil classification



# Engine Oil, Filter & Strainer Screen

## Checking & Adding Oil

Refer to *Safety Precautions* on page 82 .

RIGHT SIDE

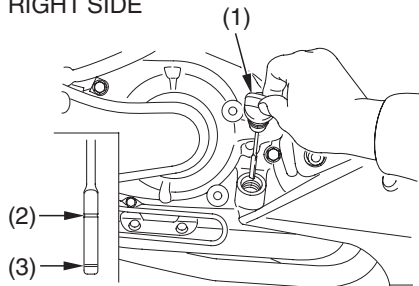

(1) oil filler cap/dipstick      (3) lower level  
(2) upper level mark              mark

1. Park your scooter on its center stand on a firm, level surface.
2. Start the engine and let it idle for 3—5 minutes.
3. Stop the engine and wait 2—3 minutes.
4. Remove the oil filler cap/dipstick (1) and wipe it clean.
5. Insert the oil filler cap/dipstick until it seats, but don't screw it in.

## Engine Oil, Filter & Strainer Screen

---

6. Remove the oil filler cap/dipstick and check the oil level.
  - If the oil is at or near the upper level mark (2) — you do not have to add oil.
  - If the oil is below or near the lower level mark (3) — add the recommended oil until it reaches the upper level mark. (Do not overfill.)
7. Reinstall the oil filler cap/dipstick.
8. Check for oil leaks.

### Changing Engine Oil & Filter and Cleaning Engine Oil Strainer Screen

Refer to *Safety Precautions* on page 82 .

This procedure requires mechanical skill and professional tools such as a torque wrench, as well as a means for disposing of the drained fluid (page 168 ). If you do not have the skills or the tools, see your Honda dealer.

# Engine Oil, Filter & Strainer Screen

## *Drain the Engine Oil:*

1. Park the scooter on its center stand on a firm, level surface.
2. If the engine is cold, start it and let it idle for 3–5 minutes. Turn the engine off. Wait 2–3 minutes for the oil to settle.
3. Place a drain pan under the oil plug (1).
4. To drain the oil, remove the oil filler cap/dipstick (2), oil plug, spring (3) and oil strainer screen (4).

## RIGHT SIDE

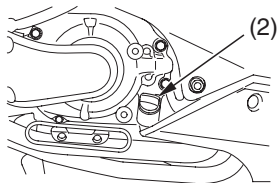

## UNDER ENGINE

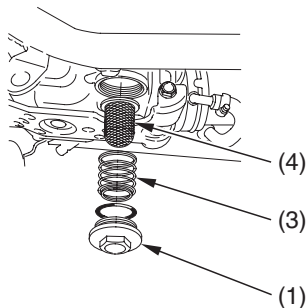

- (1) oil plug
- (2) oil filler cap/dipstick
- (3) spring
- (4) oil strainer screen

## Engine Oil, Filter & Strainer Screen

### *Install a New Oil Filter:*

5. Remove the oil filter (5) with a filter wrench and let the remaining oil drain out. Discard the oil filter in an approved manner (page 168 ).
6. Pour the drained oil into a suitable container and dispose of it in an approved manner (page 168 ).

### **NOTICE**

*Improper disposal of drained fluids is harmful to the environment.*

### UNDER ENGINE

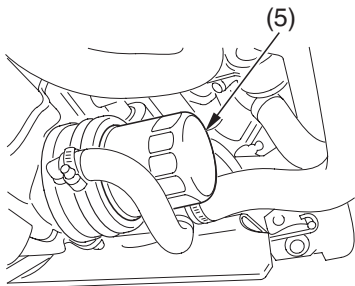

(5) oil filter

(cont'd)

## Engine Oil, Filter & Strainer Screen

---

7. Apply a thin coat of engine oil to the rubber seal (6) of a new oil filter.

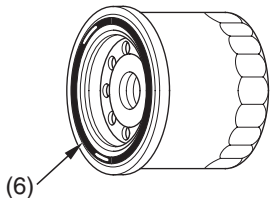

(6) oil filter rubber seal

8. Install the new oil filter and tighten it by hand.
9. Using an oil filter wrench attachment and a torque wrench, tighten the new oil filter to the specified torque:  
**20 lbf·ft (26 N·m , 2.7 kgf·m)**

10. Clean the oil strainer screen.
11. Check the oil strainer screen, sealing rubber, and oil plug O-ring are in good condition.
12. Install the oil strainer screen, spring, and oil plug. Tighten the oil plug to the specified torque:  
**11 lbf·ft (15 N·m , 1.5 kgf·m)**
13. Fill the crankcase with the recommended oil (page 109 ), approximately:  
**2.3 US qt (2.2 ℓ)**
14. Install the oil filler cap/dipstick securely.

## Engine Oil, Filter & Strainer Screen

---

15. Lock the rear wheel (page 32 ).
16. Start the engine and let it idle for 3–5 minutes.
17. Stop the engine and wait 2–3 minutes.
18. With the scooter on its center stand, check that the oil level is at upper level mark on the oil filler cap/dipstick.
19. Check that there are no oil leaks.

If a torque wrench is not used for installation, see your Honda dealer as soon as possible to verify proper assembly.

# Coolant

---

Your scooter's liquid cooling system dissipates engine heat through the coolant jacket that surrounds the cylinder and cylinder head.

Maintaining the coolant will allow the cooling system to work properly and prevent freezing, overheating, and corrosion.

## Coolant Recommendation

Use Pro Honda HP coolant or an equivalent high quality ethylene glycol antifreeze containing corrosion protection inhibitors specifically recommended for use in aluminum engines. Check the antifreeze container label.

Use only distilled water as a part of the coolant solution. Water that is high in mineral content or salt may be harmful to the aluminum engine.

### NOTICE

*Using coolant with silicate inhibitors may cause premature wear of water pump seals or blockage of radiator passages. Using tap water may cause engine damage.*

The factory provides a 50/50 solution of antifreeze and water in this scooter. This coolant solution is recommended for most operating temperatures and provides good corrosion protection.

Decreasing the concentration of antifreeze to less than 40% will not provide proper corrosion protection.

Increasing the concentration of antifreeze is not recommended because it decreases cooling system performance. Higher concentrations of antifreeze (up to 60%) should only be used to provide additional protection against freezing. Check the cooling system frequently during freezing weather.

### Checking & Adding Coolant

Refer to *Safety Precautions* on page 82 .

#### RIGHT FRONT

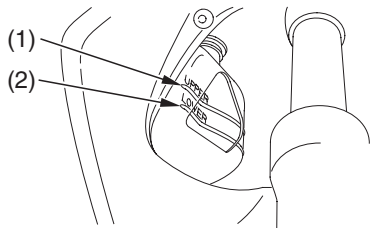

- (1) UPPER level mark
- (2) LOWER level mark



## Coolant

---

1. With the engine at normal operating temperature, check the coolant level in the reserve tank. It should be between the UPPER (1) and LOWER (2) level marks.

If the reserve tank is empty, or if coolant loss is excessive, check for leaks and see your Honda dealer for repair.

2. Remove the right fairing compartment (page 103 ).
3. Remove the reserve tank cap (3).  
Always add coolant to the reserve tank.  
Do not attempt to add coolant by removing the radiator cap.
4. Add coolant to the reserve tank as required to bring the coolant level to the UPPER level mark.

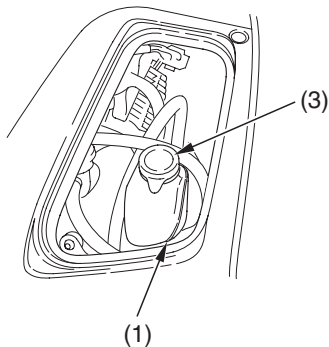

- (1) UPPER level mark  
(3) reserve tank cap

### Coolant Replacement

Refer to *Safety Precautions* on page 82 .

Coolant should be replaced by your Honda dealer, unless you have the proper tools and service data and are mechanically qualified. Refer to the official Honda Service Manual (page 212 ).

### WARNING

Removing the radiator cap while the engine is hot can cause the coolant to spray out, seriously scalding you.

Always let the engine and radiator cool down before removing the radiator cap.

To properly dispose of drained coolant, refer to *You & the Environment*, page 168 .

### NOTICE

*Improper disposal of drained fluids is harmful to the environment.*

## Air Cleaner

---

Refer to *Safety Precautions* on page 82 .

Service the air cleaner more frequently if you ride in unusually wet or dusty areas. Your Honda dealer can help you determine the correct service interval for your riding conditions.

Your scooter's air cleaner has very specific performance requirements. Use a new genuine Honda air cleaner specified for your model or an air cleaner of equivalent quality.

### NOTICE

*Using the wrong air cleaner may result in premature engine damage.*

Proper air cleaner maintenance can prevent premature engine wear or damage, expensive repairs, low engine power, poor gas mileage, and spark plug fouling.

### NOTICE

*Improper or lack of proper air cleaner maintenance can cause poor performance and premature engine wear.*

## Replacement

1. Remove the right side cover (page 101).
2. Remove the A screws (1) that secure the air cleaner housing cover (2).

RIGHT SIDE

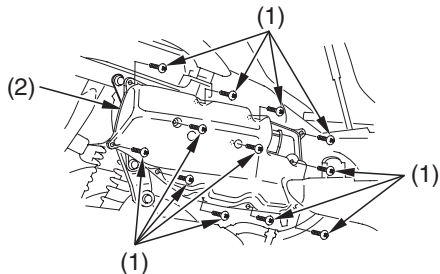

(1) A screws

(2) air cleaner housing cover

RIGHT SIDE

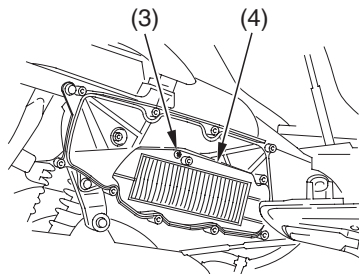

(3) B screw

(4) air cleaner

3. Remove the B screw (3) that secures the air cleaner (4).
4. Discard the air cleaner.
5. Install a new air cleaner.
6. Install the removed parts in reverse order of removal.

# Crankcase Breather

---

Refer to *Safety Precautions* on page 82 .

Service the crankcase breather more frequently if your scooter is ridden in the rain or often at full throttle. Service the breather if you can see deposits in the transparent section of the drain tube.

## Draining

### LEFT SIDE

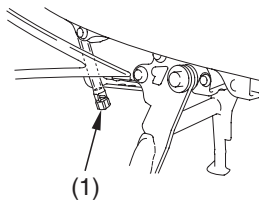

### (1) crankcase breather tube plug

1. Place a drain pan under the crankcase breather tube plug ( 1 ).
2. Remove the plug to drain the deposits in the tube.
3. Reinstall the crankcase breather tube plug.

## Throttle Freeplay

Refer to *Safety Precautions* on page 82 .

### RIGHT HANDLEBAR

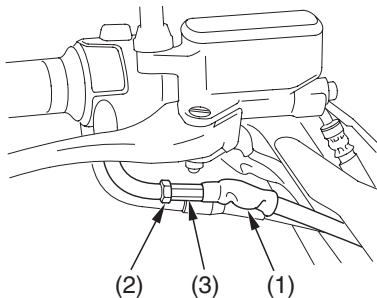

- (1) throttle cable boot
- (2) lock nut
- (3) adjuster

### Inspection

Check freeplay at the throttle grip flange.

Freeplay:

1/16 – 1/4 in (2 – 6 mm)

If necessary, adjust to the specified range.

### Adjustment

1. Slide the throttle cable boot ( 1 ).
2. Loosen the lock nut ( 2 ).
3. Turn the adjuster ( 3 ).
4. Tighten the lock nut and return the throttle cable boot securely.
5. After adjustment, check for smooth rotation of the throttle grip from fully closed to fully open in all steering positions.

# Throttle

---

## Throttle Inspection

Refer to *Safety Precautions* on page 82 .

1. Check that the throttle assembly is positioned properly and the securing bolts are tight.
2. Check for smooth rotation of the throttle from fully open to fully closed in all steering positions. If there is a problem, see your Honda dealer.

# Engine Idle Speed

Remember, idle speed adjustment is not a “cure-all” for other problems in your engine’s fuel-delivery system. Adjusting the idle will not compensate for a fault elsewhere.

The engine must be at normal operating temperature for accurate idle speed adjustment.

## Idle Speed Adjustment

Refer to *Safety Precautions* on page 82 .

UNDER SEAT

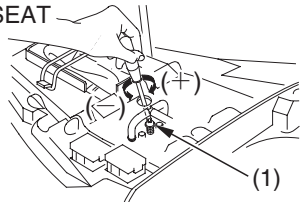

(1) throttle stop screw (+) increase  
(-) decrease

1. If the engine is cold, start it and warm it up with ten minutes of stop-and-go riding. Stop the engine.
2. Place your scooter on its center stand on a firm, level surface.

(cont'd)



## Engine Idle Speed

---

3. Open the seat (page 47 ).
4. Lock the rear wheel by lowering parking brake lever and squeezing the rear brake lever (page 32 ). Start the engine.
5. Adjust idle speed with the throttle stop screw ( 1 ).  
Idle speed:  
 $1,300 \pm 100$  rpm

## Spark Plug Recommendation

standard spark plug	CR8EH-9 (NGK) or U24FER9 (DENSO)
------------------------	-------------------------------------

Use only the recommended type of spark plugs in the recommended heat range.

### NOTICE

*Using spark plugs with an improper heat range can cause engine damage.*

## Spark Plug Replacement

Refer to *Safety Precautions* on page 82 .

1. Open the seat (page 47 ).
2. Remove the screws ( 1 ).
3. Close the seat.
4. Push the plug maintenance lid ( 2 ) backward.

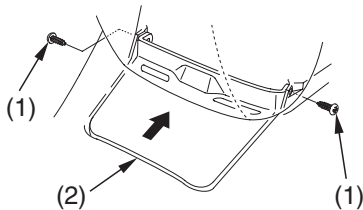

(1) screws    (2) plug maintenance lid  
(cont'd)

## Spark Plug

---

5. Remove the plug maintenance lid (2).

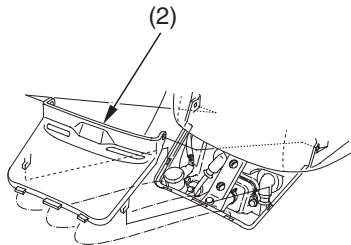

(2) plug maintenance lid

6. Disconnect the spark plug caps (3).  
Take care to avoid damaging the spark plug wire when disconnecting the caps.
7. Clean any dirt from around the spark plug bases.
- Using the spark plug wrench (4) provided in the tool kit (page 96 ), remove the spark plugs.

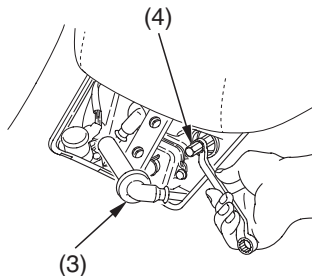

(3) spark plug caps  
(4) spark plug wrench

8. Discard the spark plugs.
9. With the plug washers attached, thread the spark plugs in by hand to prevent cross-threading.
10. Tighten each spark plug:
  - If the old plug is good:
    - 1/8 turn after it seats.
  - If installing a new plug, tighten it twice to prevent loosening:
    - a) First, tighten the plug:
      - NGK: 1/2 turn after it seats.
      - DENSO: 1 turn after it seats.
    - b) Then loosen the plug.
    - c) Next, tighten the plug again:
      - 1/8 turn after it seats.

### NOTICE

*Improperly tightened spark plugs can damage the engine. If a plug is too loose, a piston may be damaged. If a plug is too tight, the threads may be damaged.*

11. Reinstall the spark plug caps. Take care to avoid pinching any cables or wires.
12. Install the remaining parts in the reverse order of removal.

## Suspension

---

Your front and rear suspension systems use springs and hydraulic damping devices that suspend your weight and most of the weight of your scooter.

The spring pre-load for your rear suspension system adjusts the amount of force required to begin compression of the spring.

Consider adjusting your rear suspension pre-load whenever you change your normal load, by adding or subtracting a passenger, cargo, or accessories, or when the road or riding conditions change.

The way you ride your scooter and the type of ride you want to experience can also influence your suspension needs.

Lower spring pre-load provides a softer ride and is usually preferred for light loads and smooth roads. Higher spring pre-load provides a firmer ride and is recommended for heavy loads, rough road conditions, and faster, more challenging riding.

## Rear Suspension Adjustment

The rear suspension can be adjusted for rider (and passenger) weight and riding conditions by changing the spring pre-load.

Do not attempt to disassemble, service, or dispose of the damper; see your Honda dealer. The instructions found in this owner's manual are limited to adjustments of the shock assembly only.

## Rear Suspension Spring Pre-load

LEFT SIDE (right side similar)

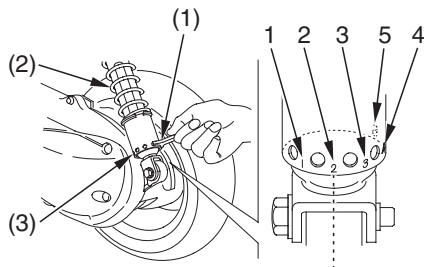

- (1) pin spanner
- (2) shock absorber
- (3) spring pre-load adjuster

## Suspension

---

The spring pre-load adjuster (3) has 5 positions for different load or riding conditions.

Use the pin spanner (1) to adjust the rear shock spring pre-load.

Position 1: for a light load and smooth road conditions.

Position 2: standard position.

Positions 3 to 5: for when the motorcycle is more heavily loaded. (Also increase spring pre-load for stiffer rear suspension.)

Make sure that both shock absorbers are adjusted to the same position.

Always adjust the shock absorber position in sequence (1-2-3-4-5 or 5-4-3-2-1).

Attempting to adjust directly from 1 to 5 or 5 to 1 may damage the shock absorber.

The hydraulic braking systems on your scooter dissipate the heat generated by the friction of the brake pads on the brake discs as the wheels are slowed.

As the brake pads wear, the brake fluid level will drop. A leak in the system will also cause the level to drop.

Frequently inspect the system to ensure there are no fluid leaks. Periodically inspect the brake fluid level and the brake pads for wear.

If the brake lever freeplay does not feel within the normal range while riding, check the brake pads for wear (page 139 ). Worn pads should be replaced. If the pads are not worn beyond the recommended limit, there is probably air in the brake system. See your Honda dealer to have the air bled from the system.



# Brakes

---

## Brake Fluid Recommendation

brake fluid	Honda DOT 4 Brake Fluid
-------------	-------------------------

The recommended brake fluid is Honda DOT 4 Brake Fluid, or any brake fluid of equal quality and performance. Use fresh brake fluid from a sealed container. Be sure to read the label before opening the sealed container. An opened container may be contaminated or may have absorbed moisture from the air.

## Fluid Level Inspection

Refer to *Safety Precautions* on page 82 .

If your inspection indicates a low fluid level, have your Honda dealer add the recommended brake fluid.

Do not add or replace brake fluid, except in an emergency. If you do add fluid, have your Honda dealer check the system as soon as possible.

### NOTICE

*Brake fluid can damage plastic and painted surfaces. Handle with care.*

Wipe up spills immediately. Avoid contact with skin or eyes. In case of contact, wash thoroughly and call a doctor immediately if it contacts your eyes.

## RIGHT HANDLEBAR

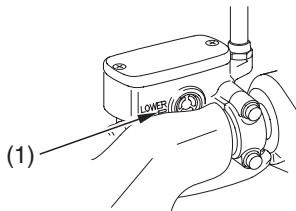

(1) LOWER level mark

## LEFT HANDLEBAR

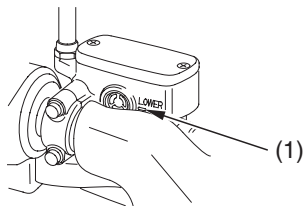

(1) LOWER level mark

1. Place your scooter in an upright position on a firm, level surface.
2. Check the fluid level.  
It should be above the LOWER level mark (1).  
If the level is at or below the LOWER level mark, check the brake pads for wear (page 139).

# Brakes

---

Worn pads should be replaced. If the pads are not worn beyond the recommended limit, have your brake system inspected for leaks.

## Other Inspections

- Make sure there are no fluid leaks.
- Check for deterioration or cracks in the hoses and fittings.

## Brake Pad Wear

Refer to *Safety Precautions* on page 82 .

Brake pad wear depends upon the severity of usage, the type of riding, and road conditions. Generally, the pads will wear faster on wet and dirty roads. Inspect the pads at each regular maintenance interval (page 90 ).

### Front Brake

Check the cutouts (1) in each pad. If either pad is worn to the cutout, replace both pads as a set. See your Honda dealer for this service.

FRONT

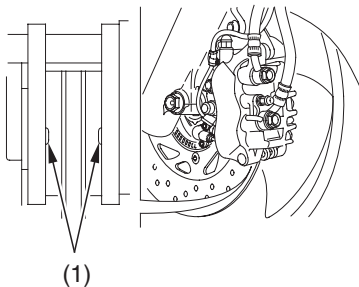

(1) cutouts

# Brakes

---

## Rear Brake

Check the cutouts (1) in each pad. If either pad is worn to the cutout, replace both pads as a set. See your Honda dealer for this service.

REAR

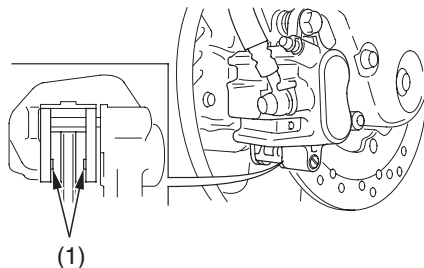

(1) cutouts

### Parking Brake Lever Freeplay

Refer to *Safety Precautions* on page 82 .

1. Stop the engine and put the scooter on its center stand on level ground.
2. Count the number of clicks before the brake starts to take hold by slowly pulling the grip down from the fully returned position.

Parking brake grip free play is:  
**3—6 clicks**

If adjustment is necessary, have the brake adjusted by your Honda dealer for this service.

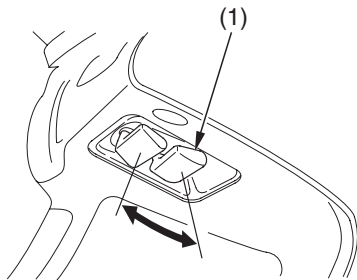

(1) parking brake lever

# Tires

---

To safely operate your scooter, your tires must be the proper type and size, in good condition with adequate tread, and correctly inflated for the load you are carrying.

## **WARNING**

Using tires that are excessively worn or improperly inflated can cause a crash in which you can be seriously hurt or killed.

Follow all instructions in this owner's manual regarding tire inflation and maintenance.

The following pages give detailed information on how and when to check

your air pressure, how to inspect your tires for wear and damage, and our recommendations for tire repair and replacement.

## **Air Pressure**

Refer to *Safety Precautions* on page 82 .

Properly inflated tires provide the best combination of handling, tread life, and riding comfort. Generally, underinflated tires wear unevenly, adversely affect handling, and are more likely to fail from being overheated. Overinflated tires make your scooter ride more harshly, are more prone to damage from road hazards, and wear unevenly.

We recommend that you visually check your tires before every ride and use an air pressure gauge to measure the air pressure at least once a month or any time you think the tires might be low. Even tires that are in good condition may lose one to two psi per month if not checked and adjusted regularly.

Tubeless tires have some degree of self-sealing ability if they are punctured. However, because leakage is often very slow, you should look closely for punctures whenever a tire is not fully inflated.

Always check air pressure when your tires are “cold” — after the scooter has been parked for at least three hours. If you check air pressure when your tires are “warm” — even if your scooter has only been ridden for a few miles — the

readings will be higher. If you let air out of warm tires to match the recommended cold pressures, the tires will be underinflated.

The recommended “cold” tire pressures are:

front	29 psi (200 kPa , 2.00 kgf/cm <sup>2</sup> )
rear	33 psi (225 kPa , 2.25 kgf/cm <sup>2</sup> ) with less than 200 lbs (90 kg) of added weight*
	36 psi (250 kPa , 2.50 kgf/cm <sup>2</sup> ) with more than 200 lbs (90 kg) of added weight*

\*includes the weight of the rider, passenger, all cargo & all accessories



# Tires

---

## Inspection

Refer to *Safety Precautions* on page 82 .

Whenever you check the tire pressures, you should also look for:

- Bumps or bulges in the side of the tire or the tread. Replace any tire that has a bump or bulge.
- Cuts, slits, or cracks in the tires. Replace the tire if you can see fabric or cord.
- Nails or other foreign objects embedded in the side of the tire or tread.
- Excessive tread wear.

Also, if you hit a pothole or hard object while riding, pull to the side of the road as soon as you safely can and carefully inspect the tires for damage.

## Tread Wear

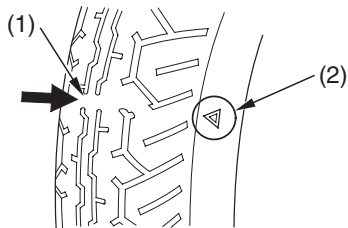

(1) wear indicator

(2) wear indicator location mark

For the best performance, you should replace a tire before the tread depth at the center reaches the following limits:

front	0.06 in (1.5 mm)
rear	0.08 in (2.0 mm)

If the wear indicators are visible, replace the tire immediately as it is no longer safe.

## Tire Repair

Refer to *Safety Precautions* on page 82 .

We strongly recommend that you replace, not repair, any tire that is punctured or damaged. As discussed below, a tire that is repaired, either temporarily or permanently, will have lower speed and performance limits than a new or undamaged tire.

A temporary repair can sometimes be made in an emergency situation.

However, since a temporary repair may not hold, you must ride very slowly, preferably without any cargo or passenger, and have the tire replaced or permanently repaired as soon as possible.

(For more information on temporary repairs, see *If You Have a Flat Tire*, page 176 .)

# Tires

---

A permanent repair, such as an internal plug patch, can be made if a tire has only a small puncture in the tread area. With such a repair, you should not exceed 50 mph (80 km/h) for the first 24 hours, or 80 mph (130 km/h) at any time thereafter. In addition, you may not be able to safely carry as much weight. If you choose to have a tire repaired, be sure the repair work is performed by a professional and that the wheel is balanced before you ride.

If you have a tire professionally repaired at a non-Honda facility, we recommend that you have the work checked by your Honda dealer.

## Tire Replacement

Refer to *Safety Precautions* on page 82 .

The tires that came on your scooter were designed to match the performance capabilities of your scooter and provide the best combination of handling, braking, durability, and comfort.

You should replace the tires with tires of the same size, load range, and speed rating as the originals.

## **⚠ WARNING**

Installing improper tires on your scooter can affect handling and stability. This can cause a crash in which you can be seriously hurt or killed.

Always use the size and type of tires recommended in this owner's manual.

The recommended tires for your scooter are:

front	120/80-14M/C 58S BRIDGESTONE HOOP B03 IRC SS530F
rear	150/70-13M/C 64S BRIDGESTONE HOOP B02 IRC SS530R
type	bias-ply, tubeless

Whenever you replace a tire, remember:

- Have the wheel balanced after the tire is installed.
- Have the tire replaced by your Honda dealer if possible.

# Tires

---

If you have a tire professionally replaced at a non-Honda facility, we recommend that you have the work checked by your Honda dealer.

## Important Safety Reminders

- Do not install a tube inside a tubeless tire on this scooter. Excessive heat build-up can cause the tube to burst.
- Use only tubeless tires on this scooter. The rims are designed for tubeless tires, and during hard acceleration or braking, a tube-type tire could slip on the rim and cause the tire to rapidly deflate.

## Side Stand

Refer to *Safety Precautions* on page 82 .

### LEFT SIDE

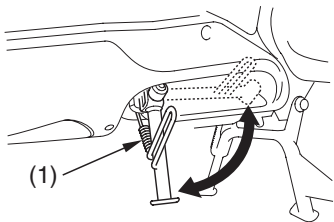

### (1) side stand spring

- Check that the side stand assembly is working properly. If the side stand is stiff or squeaky, clean the pivot area and lubricate the pivot bolt with clean grease.

- Check the side stand spring (1) for damage or loss of tension.
- Check the side stand ignition cut-off system:
  1. Sit astride the scooter.
  2. Raise the side stand.
  3. Pull the rear brake lever in.
  4. Start the engine.
  5. Lower the side stand all the way.

The engine should stop as you lower the side stand. If the engine doesn't stop, see your Honda dealer for service.

# Battery

---

Your scooter has a maintenance-free type battery. You do not have to check the battery electrolyte level or add distilled water as you would with a conventional-type battery.

## NOTICE

*Your battery is a maintenance-free type and can be permanently damaged if the cap strip is removed.*

Electrical accessories use current from the battery — even when the ignition is OFF. Limited operation also allows the battery to discharge. If you have electrical accessories on your scooter — or do not ride frequently, we recommend that you charge the battery frequently (see *Battery Charging*, page 153 ).

If you do not expect to ride your scooter for at least two weeks, we recommend you remove the battery — or at least disconnect the battery cables (negative cable first).

If you plan to store your scooter, see *Battery Storage*, page 152 .

If your battery seems weak and/or is leaking electrolyte (causing slow starting or other electrical problems), see your Honda dealer.

**WARNING:** Battery posts, terminals and related accessories contain lead and lead compounds. **Wash hands after handling.**

## Battery Storage

Refer to *Safety Precautions* on page 82 .

If you plan to store your scooter, we recommend you remove the battery and store it where it can be charged at least every 30 days to maintain its service life.

If you do not remove the battery, we recommend disconnecting the battery cables (negative cable first).

You will get the best storage results from removing the battery and slow (trickle) charging it every 30 days (see *Battery Charging*, page 153 ).

Before you remove the battery, be sure to read all the information that follows, as well as the information on the battery label.

### **WARNING**

The battery gives off explosive hydrogen gas during normal operation.

A spark or flame can cause the battery to explode with enough force to kill or seriously hurt you.

Wear protective clothing and a face shield, or have a skilled mechanic do the battery maintenance.



# Battery

The battery is located in the battery box below the seat.

1. Open the seat (page 47 ).
2. Remove the screw ( 1 ), then remove the battery cover ( 2 ).

## UNDER SEAT

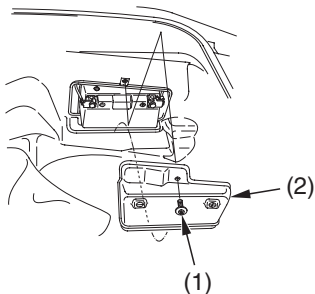

(1) screw      (2) battery cover

3. Disconnect the negative ( - ) terminal lead ( 3 ) from the battery first, then disconnect the positive ( + ) terminal lead ( 4 ).
4. Pull the battery ( 5 ) out of the battery box.

## UNDER SEAT

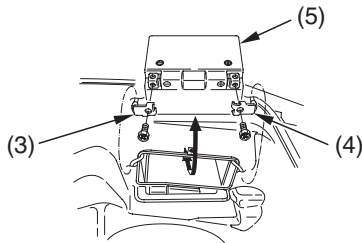

(3) negative ( - ) terminal lead  
(4) positive ( + ) terminal lead  
(5) battery

5. Charge the battery (see following section), unless you have been riding regularly.
6. Store your battery in an easy-to-reach location off the floor, in an area protected from freezing temperatures and direct sunlight.
7. Clean the battery box after removing the battery for storage. Dry the battery box and, if paint is missing, re-paint the area.
8. Slow charge the battery (see following section) once every 30 days.

## Battery Charging

Refer to *Safety Precautions* on page 82 .

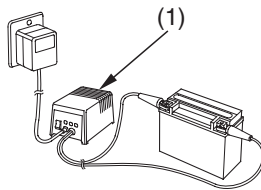

(1) “trickle” charger

Be sure to read the information that came with your battery charger and follow the instructions on the battery. Improper charging may damage the battery.

(cont'd)

## Battery

---

We recommend using a “trickle” charger (1) for home charging. These units can be left connected for long periods without risking damage to the battery. However, do not intentionally leave the charger connected longer than the time period recommended in the charger’s instructions.

Avoid using an automotive-type battery charger. An automotive charger can overheat a scooter battery and cause permanent damage.

Frequent cleaning and polishing will keep your Honda looking newer longer. Frequent cleaning also identifies you as an owner who values your scooter. A clean scooter is also easier to inspect and service.

### General Recommendations

Refer to *Safety Precautions* on page 82 .

- To clean your scooter, you may use:
  - water
  - a mild, neutral detergent and water
  - a mild spray and wipe cleaner/polisher
  - a mild spray and rinse cleaner/degreaser and water

- Avoid products that contain harsh detergents or chemical solvents that could damage the metal, paint, and plastic on your scooter.
- If your scooter is still warm from recent operation, give the engine and exhaust system time to cool off.
- Park in a shady area. Washing your scooter in bright sunlight may cause the finish to fade because water droplets intensify the sun's brightness. Spotting is also more likely because surface water can dry before you have time to wipe it off.
- Clean your scooter regularly to protect surface finishes.

(cont'd)

## Appearance Care

---

- We recommend the use of a garden hose to wash your scooter. High pressure washers (like those at coin-operated car washes) can damage certain parts of your scooter.

### NOTICE

*High pressure water (or air) can damage certain parts of your scooter.*

- After cleaning, inspect for damage, wear, and leaks (fuel, oil, coolant, and brake fluid).

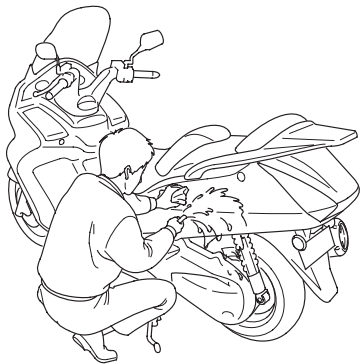

### Washing Your Scooter with a Mild Detergent

Refer to *Safety Precautions* on page 82 .

1. Rinse your scooter thoroughly with cool water to remove loose dirt.
2. Fill a bucket with cool water. Mix in a mild, neutral detergent, such as dish washing liquid or a product made especially for washing scooters or automobiles.
3. Wash your scooter with a sponge or a soft towel. As you wash, check for heavy grime. If necessary, use a mild cleaner/degreaser to remove the grime.

4. After washing, rinse your scooter thoroughly with plenty of clean water to remove any residue. Detergent residue can corrode alloy parts.
5. Dry your scooter with a chamois or a soft towel. Leaving water on the surface to air dry can cause dulling and water spots. As you dry, inspect for chips and scratches.
6. Start the engine and let it idle for several minutes. The engine heat will help dry moist areas.

(cont'd)

## Appearance Care

---

7. As a precaution, ride your scooter at a slow speed and apply the brakes several times. This will help dry the brakes and restore normal braking performance.

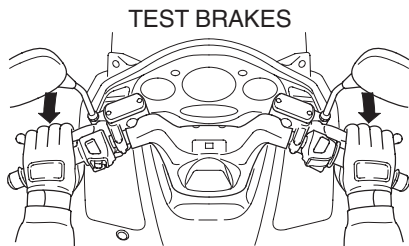

If the inside of the headlight lens appears clouded immediately after washing, it should clear after a few minutes of riding.

### Cleaning Your Windshield

Using plenty of water, clean the windshield with a soft cloth or sponge. (Avoid using detergents or any kind of chemical cleaner on the windshield.) Dry with a soft, clean cloth.

#### NOTICE

*To avoid possible scratching or other damage, use only water and a soft cloth or sponge to clean the windshield.*

For a dirtier windshield, use a diluted neutral detergent with a sponge and plenty of water. Make sure to wash off all the detergent. (Detergent residue may cause windshield cracks.)

Replace the windshield if scratches cannot be removed and they obstruct clear vision.

Take care to keep battery electrolyte, brake fluid, or other chemical solvents off the windshield. They will damage the plastic.

### Spray Cleaning Your Scooter

Refer to *Safety Precautions* on page 82 .

Avoid using spray cleaner products on the tires or suspension components.

Suggestions for using spray cleaner(s) follow:



## Appearance Care

---

<b>Scooter Condition</b>	<b>Recommended Cleaning</b>
Dust and fingerprint smudges.	Apply a spray cleaner/polish and wipe the paint, chrome, glass, and clear plastic.
Light road grime.	Spray any difficult-to-reach or very dirty areas with a spray cleaner/degreaser. Rinse and dry. Apply a spray cleaner/polish and wipe with a non-abrasive cloth.
Heavy grime. Oil leaks. Brake dust.	Use a spray cleaner/degreaser. If necessary, rub with a sponge. Rinse and dry. Apply a spray cleaner/polish and wipe with a non-abrasive cloth.
Dull, corroded chrome or aluminum.	Apply a high quality chrome/aluminum polish and wipe with a non-abrasive cloth.

### Painted Aluminum Wheel Maintenance

Refer to *Safety Precautions* on page 82 .

Aluminum may corrode from contact with dirt, mud, or road salt. Clean the wheels after riding through any of these substances. Use a wet sponge and mild detergent. Avoid stiff brushes, steel wool, or cleaners containing abrasives or chemical compounds.

After washing, rinse with plenty of water and dry with a clean cloth.

If the paint is chipped, apply touch-up paint.

### Exhaust Pipe Maintenance

Refer to *Safety Precautions* on page 82 .

The exhaust pipe is stainless steel, but may become stained by oil or mud. If necessary, remove heat stains with a liquid kitchen abrasive.

# Appearance Care

---

## Finishing Touches

Refer to *Safety Precautions* on page 82 .

After washing your scooter, consider using a commercially-available spray cleaner/polish or quality liquid or paste wax to finish the job. Use only a non-abrasive polish or wax made specifically for scooters or automobiles. Apply the polish or wax according to the instructions on the container.

If a surface on your scooter is chipped or scratched, your Honda dealer has touch-up paint to match your scooter's color. Be sure to use your scooter's color code (page 194 ) when you buy touch-up paint.

If the frame has a chip that exposes the metal, first apply primer (to prevent corrosion) and then apply the touch-up paint. Several thin layers of touch-up paint are better than one thick coat.

Here's a few helpful tips on how to store and transport your Honda, and how to be an environmentally responsible scooter owner.

Storing Your Honda .....	164
Transporting Your Scooter.....	167
You & the Environment .....	168

## Storing Your Honda

---

If you won't be riding for an extended period, such as during the winter, thoroughly inspect your scooter and correct any problem before storing it. That way, needed repairs won't be forgotten and it will be easier to get your scooter running again.

For more information about storage, refer to the *Honda Motorcycle Winter Storage Guide*, available from your Honda dealer (USA only).

We suggest you perform the following procedures to keep your scooter in top condition. These storage procedures will reduce the deterioration that can occur during storage.

### Preparation for Storage

Refer to *Safety Precautions* on page 82 .

1. Change the engine oil and filter.  
Clean the engine oil strainer screen (page 113).
2. Make sure the cooling system is filled with a 50/50% antifreeze solution (page 118 ).
3. Fill the fuel tank. Make sure the fuel fill cap is properly installed.

## Storing Your Honda

---

4. To prevent rusting in the cylinders, perform the following:
  - Remove the spark plug caps from the spark plugs (page 130). Using tape or string, secure the caps to any convenient plastic body part so that they are positioned away from the spark plugs.
  - Remove the spark plugs from the engine and store them in a safe place. Do not connect the spark plugs to the spark plug caps.
  - Pour a tablespoon (15–20 cc) of clean engine oil into each cylinder and cover the spark plug holes with a piece of cloth.
- With the engine stop switch in the RUN position, press the start button several times to crank the engine and distribute the oil.
- Reinstall the spark plugs and spark plug caps.
5. Remove the battery and charge it fully. Store it in an area protected from freezing temperatures and direct sunlight. Slow charge the battery (page 153 ) once a month.
6. Wash and dry your scooter. Wax all painted surfaces. Apply rust-inhibiting oil to the chrome pieces.
7. Inflate the tires to their recommended pressures (page 142 ).

(cont'd)

## Storing Your Honda

---

8. Store your scooter in an unheated area, free of dampness, away from sunlight, with a minimum of daily temperature variation.
9. Place your scooter on blocks to lift both tires off the floor.
10. Cover your scooter with a porous material. Avoid using plastic or similar non-breathing, coated materials that restrict air flow and allow heat and moisture to accumulate.

### Removal from Storage

Refer to *Safety Precautions* on page 82 .

1. Uncover and clean your scooter.
2. If your scooter has been stored for more than four months — change the engine oil (page 113 ).
3. If your scooter has been stored for more than two months — ask your Honda dealer to drain and replace the fuel.
4. Charge the battery (page 153 ) as required. Install the battery.
5. Perform a pre-ride inspection (page 40 ), then test-ride your scooter at low speeds.

## Transporting Your Scooter

---

If your scooter needs to be transported, it should be carried on a motorcycle trailer, or a truck or trailer with a flatbed area. For information about 24-hour emergency assistance, see page 219 (USA only). Do not tow your scooter, as towing can seriously damage the transmission.

When contacting a towing or transporting service, be sure to ask if they have a flatbed area, a loading ramp or power ramp to safely lift the scooter, and motorcycle tie-down straps.



## You & the Environment

---

Owning and riding a scooter can be enjoyable, but you must do your part to protect nature.

Following are tips on how you can be an environmentally-responsible scooter owner.

- **Choose Sensible Cleaners.** Use a biodegradable detergent when you wash your scooter. Avoid aerosol spray cleaners that contain chlorofluorocarbons (CFCs) which damage the atmosphere's protective ozone layer. Don't throw cleaning solvents away; see the following guidelines for proper disposal.

- **Recycle Wastes.** It's illegal and thoughtless to put used engine oil in the trash, down a drain, or on the ground. Used oil, gasoline, coolant, and cleaning solvents contain poisons that can hurt refuse workers and contaminate our drinking water, lakes, rivers, and oceans. Before changing your oil, make sure you have the proper containers. Put oil and other toxic wastes in separate sealed containers and take them to a recycling center. Call your local or state office of public works or environmental services to find a recycling center in your area, and to get instructions on how to dispose of non-recyclable wastes.

## Taking Care of the Unexpected

---

This section discusses the more common problems that can occur with your scooter while you're riding. It tells you how to evaluate each problem and what actions you can take to try to resume riding. If the problem cannot be safely solved, this section also gives instructions on the proper way to have your scooter transported.

For information about transporting your scooter, see page 167 .

General Guidelines .....	170
If Your Engine Quits or Won't Start ...	171
If You Have a Flat Tire .....	176
If Your Engine Overheats .....	180
If the Low Oil Pressure Indicator	
Lights .....	182
If a Fuse Blows.....	183
If You Crash .....	187
If You Lose Your Key .....	188
If Your Battery is Low (or Dead) .....	189

# Taking Care of the Unexpected

---

## General Guidelines

Keeping your scooter well-maintained is the best way to reduce the possibility of having a problem on the road. However, since problems can arise even with well-maintained machines, you may consider subscribing to an emergency roadside service plan. (USA only: For information about the Honda Rider's Club of America, see page 219.)

Remember to take along your owner's manual, the tool kit that came with your scooter, and any other items (such as tire repair supplies and additional tools) that might help you solve a problem on your own.

Should you ever have a problem while riding, please follow these guidelines:

- Always put personal safety first.
- Take time to assess the situation and your options before deciding what to do.
- If the problem is relatively minor and you have the tools, supplies, and skills to make a temporary repair, be sure to have permanent repairs made as soon as possible.
- Do not continue riding if you are hurt or your scooter is not in safe riding condition.

Additional recommendations for specific problems follow.

## If Your Engine Quits or Won't Start

---

Proper operation and maintenance can prevent starting and engine performance problems. In many cases, the cause of the problem may be a simple operational oversight.

If you have a problem starting the engine — or experience poor engine performance — the following information may help you. If you can't correct the problem, see your Honda dealer.

If your scooter won't start, listen as you press the start button. If you don't hear the starter motor turning, refer to the *Starter motor doesn't operate* symptom. If you can hear the starter motor working normally, refer to the *Starter motor works, but the engine won't start* symptom.

## If Your Engine Quits or Won't Start

---

SYMPTOM: <b>Starter motor doesn't operate.</b>	
POSSIBLE CAUSE	WHAT TO DO
ignition switch OFF	Turn the ignition switch ON.
side stand down	Raise the side stand.
blown fuse	Replace with a new fuse of the same rating (page 183 ).
battery lead loose	Tighten the battery lead.
dead battery	Charge the battery (page 153 ). If charging doesn't help, see your Honda dealer.
faulty starter motor	If all possible causes are negative, the starter motor may be faulty. See your Honda dealer.

## If Your Engine Quits or Won't Start

---

SYMPTOM: <b>Starter motor works, but the engine won't start.</b>	
POSSIBLE CAUSE	WHAT TO DO
engine stop switch OFF	Turn the engine stop switch to RUN.
out of fuel	Fill the fuel tank.
flooded engine	See <i>Flooded Engine</i> (page 59).
loose or unconnected spark plug caps	Install the spark plug caps securely. If the engine still won't start, see your Honda dealer.
loose battery cables	Tighten the battery terminal bolts.
weak battery	Charge the battery (page 153). If charging doesn't help, see your Honda dealer.

## If Your Engine Quits or Won't Start

---

SYMPTOM: <b>Engine starts, but runs poorly.</b>	
POSSIBLE CAUSE	WHAT TO DO
idles roughly, too fast, stalls	Check engine idle adjustment (page 127). If the problem persists, see your Honda dealer.
overheating	Check the coolant temperature indicator. Refer to <i>If Your Engine Overheats</i> , page 180.
low oil pressure	Check the low oil pressure indicator. Refer to <i>If the Low Oil Pressure Indicator Lights</i> , page 182.
runs erratically, misfires	See your Honda dealer.
blubbers (rich fuel mixture)	See your Honda dealer.

## If Your Engine Quits or Won't Start

---

SYMPTOM: <b>Engine starts, but runs poorly. (cont'd)</b>	
POSSIBLE CAUSE	WHAT TO DO
sooty exhaust (rich fuel mixture)	See your Honda dealer.
detonates or pings under load	If applicable, switch to the recommended octane gasoline (page 104 ) or change your brand of gasoline. If the problem persists, see your Honda dealer.
afterfires (backfires)	See your Honda dealer.
pre-ignition (runs on after ignition switched OFF)	See your Honda dealer.



## If You Have a Flat Tire

---

A flat tire is always unwelcome, especially if you are far from help. If you think you are losing air, or you hit a pothole or hard object, pull safely to the side of the road so you can inspect the tires and assess the situation. (Be sure to park on a firm, level surface and use the center stand for support.) You should examine the tire treads and sidewalls for foreign objects or damage. If you find a tire that has been punctured or damaged, you have two options.

### Option 1:

#### Have Your Scooter Transported

If a tire has a major puncture or a cut in the tread or sidewall, or the bead has come loose from the rim, there is probably not much you can do except have your scooter transported to a Honda dealer or other

qualified service facility. (USA only: For information about 24-hour emergency roadside assistance, see page 119.) Even with a simple puncture, this may be the safest and least troublesome solution. For transporting instructions, see page 167 .

### Option 2:

#### Make a Temporary Roadside Repair

If a tire has only a minor nail puncture and is not completely flat, you may be able to make an emergency repair that could allow you to continue riding to where you can get the tire replaced or permanently repaired.

## If You Have a Flat Tire

### **⚠ WARNING**

Riding your scooter with a temporary tire repair can be risky. If the temporary repair fails, you can crash and be seriously injured or killed.

If you must ride with a temporary tire repair, ride slowly and carefully and do not exceed 30 mph (50 km/h) until the tire is permanently repaired or replaced.

Due to the uncertainty of any temporary repair, you should ride slowly (not over 30 mph, 50 km/h) and carefully (preferably without a passenger or cargo) until the tire is replaced or permanently repaired. Stop

frequently and check the air pressure. If the tire is losing pressure, it may be unsafe to continue riding. As the tire gets low, it will affect the handling of your scooter (especially with a passenger and cargo) and it may overheat and blow out.

### **Types of Temporary Repairs**

The following types of temporary repairs generally require a source of air to inflate the tire. Possible sources include CO<sub>2</sub> cartridges or cans of compressed air designed to inflate a tire.

(cont'd)

## If You Have a Flat Tire

---

- **Inflate the tire:** Tubeless tires have some self-sealing ability if they are punctured and the result is usually just a slow leak. If this is the case, you can try inflating the tire to see if it will hold air pressure. If you can see a nail or other object embedded in the tire tread, do not remove it at this time.
- **Plug the hole:** The idea here is to do something to temporarily stop the leak. If you have a tubeless tire repair kit, you can pull out the nail and try inserting an external plug in the puncture. Follow the instructions that came with the repair kit and be sure to inflate the tire to the correct pressure.

### Should You Repair or Replace a Tire?

We strongly recommend that you replace, not permanently repair, any tire that is punctured or damaged, even if the tire has only a minor puncture. For a full discussion of repairs and replacement, see page 145.

### Emergency Wheel Removal/Installation

Refer to *Safety Precautions* on page 82 .

We recommend wheel removal be done only by your Honda dealer or another qualified mechanic. Do not attempt to remove the wheel on your own. Wheel removal requires mechanical skill and professional tools.

## If Your Engine Overheats

---

Normally, the coolant temperature on your temperature meter will rise and then level off. Hot weather may cause the temperature to rise higher than normal. So will temporary stress such as climbing a hill. If you're stuck in stop-and-go traffic, the temperature may climb some, but the radiator fan is designed to prevent overheating. Be aware of these variations as you monitor the meter.

If the coolant temperature indicator comes on, and the coolant temperature meter displays five segments for no apparent reason, pull safely to the side of the road. If possible, park in a shady area.

### NOTICE

*Continuing to ride with an overheated engine can cause serious engine damage.*

- A steaming engine indicates a coolant leak. Shut the engine off and wait until the steaming stops. Look for a leak, but don't touch the engine or radiator system. Let everything cool off first.
- If there's no obvious problem, leave the engine on so the fan and coolant circulating system can continue working. Monitor the temperature meter. The temperature may drop to the normal range after a brief stop with no load on the engine.

## If Your Engine Overheats

---

- Check the radiator fan.  
If the fan is not working, turn the engine off. Open the fuse box (page 183 ) and check the radiator fan fuse. If the fuse is blown, replace it with the proper (same rating) spare fuse. Start the engine. If the coolant temperature indicator come on, and the coolant temperature meter displays five segments, turn the engine off.  
If the radiator fan is working, visually check the coolant level in the reserve tank, located under the right fairing compartment (page 119 ). It isn't necessary to touch the radiator system.
- If the reserve tank is low or empty, don't ride without adding coolant (page 119 ). After adding coolant, turn the engine on and check the temperature meter.  
If the temperature doesn't drop, do not

ride. The engine needs repair. Transport your motorcycle to a Honda dealer (page 167 ).

If the temperature drops to normal, check the coolant level. If it has gone down, add more coolant.

If you are able to resume riding, continue to monitor the meter frequently.

If there's a mild leak, you can ride for awhile, carefully watching the meter. Be prepared to stop and add more coolant or water. If the leak is bad, transport your motorcycle to a Honda dealer (page 167 ).

## If the Low Oil Pressure Indicator Lights

---

If you check your engine oil level regularly, you should never see the low oil pressure indicator while riding. Normally, it will only light momentarily when you turn the ignition switch ON. Occasionally, it may flicker at or near idling speed.

Low oil pressure may be caused by an oil leak, a low oil level, or some problem in the engine's lubrication system.

If the indicator comes on while you're riding, don't ignore it. Pull safely to the side of the road. Stop the engine as soon as it's safe to do so.

### NOTICE

*Continuing to ride with low oil pressure can cause serious engine damage.*

- Check for an oil leak.
- Then check the oil level. If necessary, add the recommended oil (page 109 ) to the upper level mark. If you must leave your scooter to get oil, secure it as much as possible.
- After adding oil, start the engine, and check that the low oil pressure indicator goes off. Check for a possible leak. If the indicator goes off and there is no leak — resume riding. If there is a leak — do not ride the scooter until the leak is repaired by a Honda dealer.

## If a Fuse Blows

All of the electrical circuits on your scooter have fuses to protect them from damage caused by excess current flow (short circuit or overload).

If something electrical on your scooter stops working, the first thing you should check for is a blown fuse.

Determine from the chart on the circuit fuse box cover which fuse or fuses control that component. Check those fuses first, but check all the fuses before looking elsewhere for another possible cause of the problem. Replace any blown fuses and check component operation.

- The main fuse A (and spare) is located on the starter motor magnetic switch inside the left side cover.

- The main fuse B and circuit fuse boxes (including spare fuses) are located under the seat.
- A spare circuit fuse is located in the fuse box.

### Recommended Fuses

main fuse A	30A
main fuse B	30A
other fuses	FSC600D: 10A, 15A
	FSC600A: 10A, 15A, 30A

1. To prevent an accidental short circuit, turn the ignition switch OFF before checking or replacing the fuses.

(cont'd)



## If a Fuse Blows

---

### *Main Fuse A Access:*

2. To access the main fuse A (1), remove the left side cover (page 99).

### LEFT SIDE

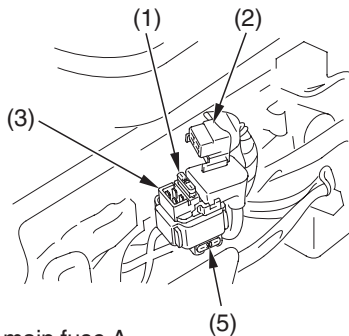

- (1) main fuse A
- (2) wire connector
- (3) starter magnetic switch
- (5) spare main fuse A

3. Disconnect the wire connector (2) of the starter magnetic switch (3).
4. Pull the main fuse out. If it is blown (4), install the spare main fuse (5).

### MAIN FUSE

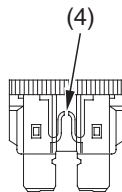

- (4) blown fuse
5. Reconnect the wire connector.
  6. Install the left side cover.

## If a Fuse Blows

### Main Fuse B and Circuit Fuse Access:

7. Open the seat (page 47 ).
8. Open the fuse box covers ( 6 ).

### UNDER SEAT

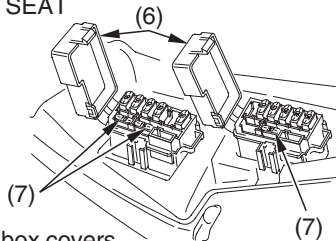

- (6) fuse box covers  
(7) spare fuses

9. To check or replace a circuit fuse, pull the old fuse out of its retaining clips. Look for a burned wire inside the fuse. If the fuse is blown ( 4 ), replace it with a spare fuse ( 7 ) of the same rating or lower.

### CIRCUIT FUSE

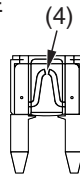

- (4) blown fuse

10. Close the fuse box cover.
11. Close the seat.

If you do not have a replacement fuse with the proper rating for the circuit, install one with a lower rating.

### NOTICE

*Replacing a fuse with one that has a higher rating greatly increases the chance of damage to the electrical system.*

## If a Fuse Blows

---

If you do not have a spare fuse and you cannot ride the scooter without fixing the problem, take a fuse of the same rating or a lower rating from one of the other circuits that you can do without temporarily.

If you replace a blown fuse with a spare fuse that has a lower rating, replace the fuse with the correct rating as soon as you can. Also remember to replace any spare fuses that were installed.

If the replacement fuse of the same rating burns out in a short time, there is probably a serious electrical problem on your scooter. Leave the blown fuse in that circuit and have your scooter checked by your Honda dealer.

Personal safety is your first priority after any accident. If you or anyone else has been injured, take time to assess the severity of the injuries and whether it is safe to continue riding. Call for emergency assistance if needed. Also follow applicable laws and regulations if another person or vehicle is involved in the accident.

If you decide you are capable of riding safely, carefully inspect your scooter for damage and determine if it is safe to ride. Check the tightness of critical nuts and bolts securing such parts as the handlebar, control levers, brakes, and wheels.

If there is minor damage, or you are unsure about possible damage, ride slowly and cautiously. Sometimes, crash damage is hidden or not immediately apparent, so you should have your scooter thoroughly checked at a qualified service facility as soon as possible. Also, be sure to have your Honda dealer check the frame and suspension after any serious crash.

If your scooter cannot be ridden, see *Transporting Your Scooter*, page 167 .

## If You Lose Your Key

---

You should receive a key number plate (1) with your keys. Store this plate in a safe place.

Be sure to record your key number in the Quick Reference section at the rear of the manual. You'll need this number to have a duplicate key made.

A lost key won't be a problem if you take preventative action. Store one duplicate key in a safe place at home and carry a second duplicate in your wallet.

If you lose your key and aren't carrying a duplicate, either get your spare or have one made. If you don't know your key number, call the dealer you purchased your Honda from. They may have it listed in their records. If they don't, transport

your scooter to them or the nearest Honda dealer. The dealer will probably have to remove the ignition switch assembly to find the key number so they can make a key for you.

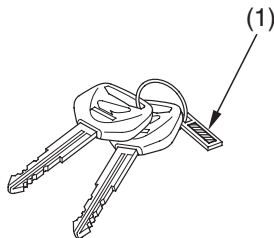

(1) key number plate

## If Your Battery is Low (or Dead)

---

Jump starting is not recommended, especially if you use an automobile battery. The greater amperage of an automobile battery when the car engine is running can damage your scooter's electrical system.

Bump starting is also not recommended.

If you can't charge the battery or it appears unable to hold a charge, contact your Honda dealer.



## Technical Information

---

This section contains dimensions, capacities, and other technical data, plus information on government requirements and how to break-in your scooter.

Vehicle Identification.....	192
Specifications .....	195
Break-in Guidelines.....	201
Emission Control Systems .....	202
Catalytic Converter .....	208
Oxygenated Fuels .....	209



# Vehicle Identification

---

## Serial Numbers

The frame, VIN, and engine serial numbers are required when you register your scooter. They may also be required when ordering replacement parts. You may record these numbers in the Quick Reference section at the rear of this manual.

The VIN (vehicle identification number) appears on the Safety Certification Label attached under the right front air cover.

RIGHT FRONT (under air cover)

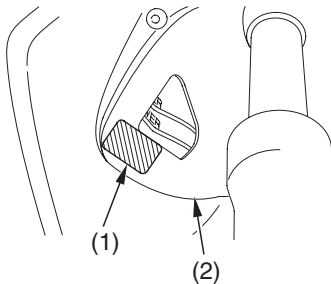

- (1) VIN
- (2) right front air cover

## Vehicle Identification

The frame number (3) is stamped on the right side of the frame body.

RIGHT SIDE

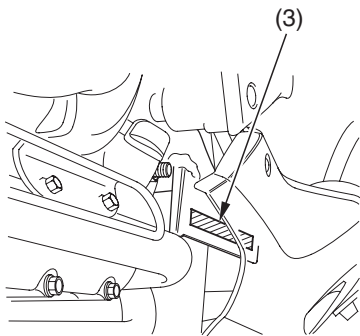

(3) frame number

The engine number (4) is stamped on the left side of the crankcase.

LEFT SIDE

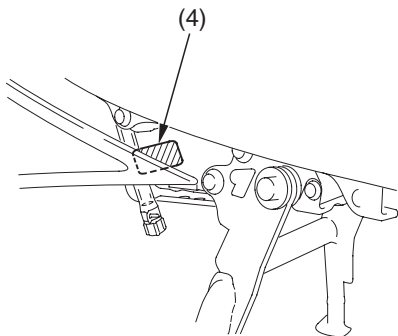

(4) engine number

# Vehicle Identification

---

## Color Label & Code

The color label is located in the center compartment.

The color code is helpful when ordering replacement parts. You may record the color and code in the Quick Reference section at the rear of this manual.

### INSIDE CENTER COMPARTMENT

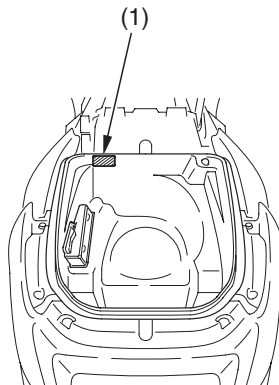

(1) color label

## Specifications

<b>Dimensions</b>	
overall length	89.6 in (2,275 mm)
overall width	30.3 in (770 mm)
overall height	56.3 in (1,430 mm)
wheelbase	62.8 in (1,595 mm)
ground clearance	5.5 in (140 mm)

<b>Weight</b>	
dry weight	485 lbs (220 kg) ...FSC600D
	503 lbs (228 kg) ...FSC600A

## Specifications

---

<b>Fuel &amp; Lubricants</b>	
fuel recommendation	unleaded gasoline, pump octane number of 86 or higher
fuel tank capacity	4.23 US gal (16.0 ℓ) including reserve
engine oil capacity	after disassembly: 2.7 US qt (2.6 ℓ) after draining: 2.1 US qt (2.0 ℓ) after draining & oil filter change: 2.3 US qt (2.2 ℓ)
engine oil recommendation	API Service Classification SG or higher except oils labeled as energy conserving on the circular API service label, SAE 10W-40, JASO T 903 standard MA or MB, Pro Honda GN4, HP4 (without molybdenum additives) or HP4M (with molybdenum additives) 4-stroke oil or an equivalent motorcycle oil
cooling system, recommendation	Pro Honda HP Coolant or an equivalent high quality ethylene glycol antifreeze containing corrosion protection inhibitors specifically recommended for use in aluminum engines
cooling system, capacity	3.2 US qt (3.0 ℓ)

## Specifications

<b>Capacities</b>	
passenger capacity	operator, one passenger
maximum weight capacity	USA: 366 lbs (166 kg) Canada: 375 lbs (170 kg) rider, passenger, all cargo and accessories

<b>Engine Specifications</b>	
displacement	35.5 cu-in (582 cm <sup>3</sup> )
bore & stroke	2.83 × 2.81 in (72.0 × 71.5 mm)
compression ratio	10.2 : 1
spark plug (standard)	CR8EH-9 (NGK) or U24FER9 (DENSO)
spark plug gap	0.031 – 0.035 in (0.80 – 0.90 mm)
valve clearance (cold)	intake: 0.006 in (0.16 mm) exhaust: 0.009 in (0.22 mm)
idle speed	1,300 ± 100 rpm

# Specifications

---

<b>Power Transmission</b>	
primary reduction	V-Belt
final reduction	6.016

<b>Chassis &amp; Suspension</b>	
caster	28°30'
trail	4.1 in (105 mm)
tire size, front	120/80-14M/C 58S
tire size, rear	150/70-13M/C 64S
tire type	bias-ply, tubeless
tire pressure, front (cold)	29 psi (200 kPa , 2.00 kgf/cm <sup>2</sup> )
tire pressure, rear (cold)	33 psi (225 kPa , 2.25 kgf/cm <sup>2</sup> ) — less than 200 lbs (90 kg) of added weight 36 psi (250 kPa , 2.50 kgf/cm <sup>2</sup> ) — more than 200 lbs (90 kg) of added weight

<b>Electrical</b>	
battery	12V-11 (10) Ah
generator	0.441 kW/5,000 rpm

## Specifications

---

<b>Lights</b>	
headlight	12V-55W × 2
brake/tail light	12V-21/5W × 2
turn signal lights	12V-21W × 2 (front) 12V-21W × 2 (rear)
license light	12V-5W
trunk light	12V-3.4W



# Specifications

---

<b>Fuses</b>	
main A	30A
main B	30A
other fuses	FSC600D: 10A, 15A
	FSC600A: 10A, 15A, 30A

<b>Torque Specifications</b>	
oil plug	11 lbf·ft (15 N·m , 1.5 kgf·m)
oil filter	20 lbf·ft (26 N·m , 2.7 kgf·m)

## Break-in Guidelines

---

Help assure your scooter's future reliability and performance by paying extra attention to how you ride during the first 300 miles (500 km).

During this period, avoid full-throttle starts and rapid acceleration.

# Emission Control Systems

---

## Exhaust Emission Requirements

The U.S. Environmental Protection Agency (EPA), the California Air Resources Board (CARB), and Environment Canada require that your scooter comply with applicable exhaust emissions standards during its useful life, when operated and maintained according to the instructions provided.

## Noise Emission Requirements

The EPA also requires that scooters built after January 1, 1983 comply with applicable noise emission standards for one year or 3,730 miles (6,000 km) after the time of sale to the ultimate purchaser, when operated and maintained according to the instructions provided. (USA only)

## Warranty Compliance

Compliance with the terms of the Distributor's Warranties for Honda Scooter Emission Control Systems is necessary in order to keep the emissions system warranty in effect. (USA only)

### UNDER SEAT

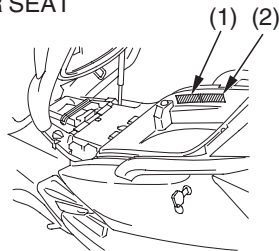

- (1) vehicle emission control information label
- (2) vehicle emission control information label (Canada only)

## Emission Control Systems

---

The Vehicle Emission Control Information label ( 1 ) is attached to the inside of the center compartment.

### **Source of Exhaust Emissions**

The combustion process produces carbon monoxide (CO), oxides of nitrogen (NOx), and hydrocarbons (HC). Control of hydrocarbons and oxides of nitrogen is very important because, under certain conditions, they react to form photochemical smog when subjected to sunlight. Carbon monoxide does not react in the same way, but it is toxic.

Honda Motor Co., Ltd. utilizes various systems to reduce hydrocarbons, oxides of nitrogen, and carbon monoxide.

# Emission Control Systems

---

## **Exhaust Emission Control System**

The exhaust emission control system includes a secondary air supply system, a PGM-FI system, and an oxidation catalytic converter.

No adjustment to these systems should be made although periodic inspection of the components is recommended.

## ***PGM-FI System***

The PGM-FI system uses sequential multiport fuel injection. It has four subsystems: Air Intake, Engine Control, Fuel Control, and Exhaust Control.

The Engine Control Module (ECM) uses various sensors to determine how much air is going into the engine. It then controls how much fuel to inject under all operating conditions.

## ***Ignition Timing Control System***

The system constantly adjusts the ignition timing, reducing the amount of HC, CO and NO<sub>x</sub> produced.

## Emission Control Systems

---

### ***Secondary Air Injection System***

The secondary air injection system introduces filtered air into the exhaust gases in the exhaust port. The secondary air injection system helps improve emission performance.

### ***Oxidation Catalytic Converter***

The oxidation catalytic converter is in the exhaust system. Through chemical reactions, they convert HC and CO in the engine's exhaust to carbon dioxide (CO<sub>2</sub>) and water vapor.

### **Evaporative Emission Control System**

This scooter complies with the requirements of the California Air Resources Board (CARB) evaporative emission regulations. Fuel vapor from the fuel tank is directed into the charcoal canister and air cleaner where it is adsorbed and stored while the engine is stopped. When the engine is running and the purge control solenoid valve is open, fuel vapor in the charcoal canister and air cleaner is drawn into the engine through the throttle body.

# Emission Control Systems

---

## **Crankcase Emission Control System**

The engine is equipped with a closed crankcase system to prevent discharging crankcase emissions into the atmosphere. Blow-by gas is returned to the combustion chamber through the air cleaner and the intake manifold.

## **Problems That May Affect Scooter Exhaust Emissions**

If you are aware of any of the following symptoms, have the vehicle inspected and repaired by your authorized Honda scooter dealer.

Symptoms:

1. Hard starting or stalling after starting
2. Rough idle
3. Misfiring or backfiring during acceleration
4. After-burning (backfiring)
5. Poor performance (driveability) and poor fuel economy

## Emission Control Systems

---

### **Noise Emission Control System TAMPERING WITH THE NOISE CONTROL SYSTEM IS PROHIBITED:**

U. S. federal law prohibits, or Canadian provincial laws may prohibit the following acts or the causing thereof: (1) The removal or rendering inoperative by any person, other than for purposes of maintenance, repair or replacement, of any device or element of design incorporated into any new vehicle for the purpose of noise control prior to its sale or delivery to the ultimate purchaser or while it is in use; or (2) the use of the vehicle after such device or element of design has been removed or rendered inoperative by any person.

### **AMONG THOSE ACTS PRESUMED TO CONSTITUTE TAMPERING ARE THE FOLLOWING ACTS:**

1. Removal of, or puncturing the muffler, baffles, header pipes or any other component which conducts exhaust gases.
2. Removal of, or puncturing of any part of the intake system.
3. Lack of proper maintenance.
4. Replacing any moving parts of the vehicle, or parts of the exhaust or intake system, with parts other than those specified by the manufacturer.



## Catalytic Converter

---

This scooter is equipped with an oxidation catalytic converter.

The catalytic converter contains precious metals that serve as catalysts, promoting chemical reactions to convert the exhaust gasses without affecting the metals.

The catalytic converter acts on HC and CO. A replacement unit must be an original Honda part or its equivalent.

The catalytic converter must operate at a high temperature for the chemical reactions to take place. It can set fire to any combustible materials that come near it. Park your scooter away from high grasses, dry leaves, or other flammables.

A defective catalytic converter contributes to air pollution, and can impair your engine's performance. Follow these guidelines to protect your scooter's catalytic converter.

- Always use unleaded gasoline. Even a small amount of leaded gasoline can contaminate the catalyst metals, making the catalytic converter ineffective.
- Keep the engine tuned-up.
- Have your scooter diagnosed and repaired if it is misfiring, backfiring, stalling or otherwise not running properly.

## Oxygenated Fuels

---

Some conventional gasolines are being blended with alcohol or an ether compound. These gasolines are collectively referred to as oxygenated fuels. To meet clean air standards, some areas of the United States and Canada use oxygenated fuels to help reduce emissions. If you use an oxygenated fuel, be sure it is unleaded and meets the minimum octane rating requirement.

Before using an oxygenated fuel, try to confirm the fuel's contents. Some states/provinces require this information to be posted on the pump.

The following are the EPA-approved percentages of oxygenates:

ETHANOL (ethyl or grain alcohol) 10%  
by Volume

You may use gasoline containing up to 10% ethanol by volume. Gasoline containing ethanol may be marketed under the name "Gasohol".

MTBE (Methyl Tertiary Butyl Ether) 15%  
by Volume

You may use gasoline containing up to 15% MTBE by volume.

## Oxygenated Fuels

---

METHANOL (methyl or wood alcohol)  
5% by Volume

You may use gasoline containing methanol containing up to 5% methanol by volume as long as it also contains cosolvents and corrosion inhibitors to protect the fuel system. Gasoline containing more than 5% methanol by volume may cause starting and/or performance problems. It may also damage metal, rubber, and plastic parts of your fuel system.

If you notice any undesirable operating symptoms, try another service station or switch to another brand of gasoline.

Fuel system damage or performance problems resulting from the use of an oxygenated fuel containing more than the percentages of oxygenates mentioned above are not covered under warranty.

Oxygenated fuels can damage paint and plastic. Be careful not to spill fuel when filling the fuel tank. Wipe up any spills immediately.

### NOTICE

*Oxygenated fuels can damage paint and plastic. Damage caused by spilled fuel is not covered by warranty.*

## Consumer Information

---

This section contains information on your warranty and how to get an official Honda service manual.

Authorized Manuals .....	212
Warranty Coverage .....	215
Warranty Service .....	216
Contacting Honda.....	217
Your Honda Dealer .....	218
The Honda Rider's Club (USA only) .....	219
Reporting Safety Defects (USA only) .....	220

## Authorized Manuals

---

The Service Manual used by your authorized Honda dealer is available from Helm, Inc. (USA only, Canada: See your Honda dealer to order authorized manuals.)

Also available, but not necessary, to service your model is the Honda Common Service Manual which explains theory of operation and basic service information for various systems common to all Honda motorcycles, motor scooters and ATVs.

These Honda manuals are written for the professional technician, but most mechanically-capable owners should find them easy to use if they have the proper tools and observe proper safety standards. Special Honda tools are necessary for some procedures.

Publication Item No.	Description	Price Each*
61MCT03	2005 FSC600D/A SILVER WING Service Manual	\$60.00
61CM002	Common Service Manual	\$48.00
31MCT630	2005 FSC600D/A SILVER WING Owner's Manual	\$16.00

*\* Prices are subject to change without notice and without incurring obligation.*

**Order On-Line: [www.helminc.com](http://www.helminc.com)**

**Order Toll Free: 1-888-CYCLE93 (1-888-292-5393)**

*(NOTE: For Credit Card Orders Only)*

**Monday — Friday 8:00 AM — 6:00 PM EST**

**OR**

By completing this form you can order the materials desired. You can pay by check or money order, or charge to your credit card. Mail to Helm, Inc. at the address shown on the back of this order form (USA only).

Canada: See your Honda dealer to order authorized manuals.

<b>Publication Item No.</b>	<b>Item Description</b>	<b>Qty.</b>	<b>Price Each*</b>	<b>Total Price</b>
*Prices are subject to change without notice and without incurring obligation.  Orders are mailed within 10 days. Please allow adequate time for delivery.		<b>Sub Total</b>		
		<b>Purchaser's Sales Tax</b>		
		<b>Mich. Add 6 %</b>		
		<b>Calif. Add 8.25 %</b>		
		<b>Handling Charge</b>		<b>\$5.00</b>
		<b>Grand Total</b>		

**S  
H  
I  
P  
T  
O**

NOTE: Dealers and Companies please provide dealer or company name, and also the name of the person to whose attention the shipment should be sent.

Customer Name \_\_\_\_\_ Attention \_\_\_\_\_

Street Address - No P. O. Box Number \_\_\_\_\_ Apartment Number \_\_\_\_\_

City \_\_\_\_\_ State \_\_\_\_\_ Zip Code \_\_\_\_\_

Daytime Telephone Number (       ) \_\_\_\_\_

**P  
A  
Y  
M  
E  
N  
T**

Check or money order enclosed payable to Helm Inc.  
U.S. funds only. Do not send cash.

Check here if your billing address is different from the  
shipping address shown above.

MasterCard

Account Number

Expiration: Mo. Yr.

--	--	--	--

--	--	--	--

--	--	--	--

--	--	--	--

—
---

VISA

Discover

Customer Signature \_\_\_\_\_ Date \_\_\_\_\_

These Publications cannot be returned for credit without receiving advance authorization within 14 days of delivery. On returns, a restocking fee may be applied against the original order.

**HELM** P.O. BOX 07280, DETROIT, MICHIGAN 48207

## Warranty Coverage

---

Your new Honda is covered by these warranties:

- Scooter Limited Warranty
- Exhaust Emission Warranty
- Noise Control Warranty

There are responsibilities, restrictions, and exclusions which apply to these warranties. Please read the Warranties Booklet given to you by your Honda dealer at the time of purchase. Be sure to keep your Honda owner's card with your Warranties Booklet (USA only).

It is important to realize that your warranty applies to defects in material or workmanship of your Honda. Your warranty coverage does not apply to normal wear or deterioration associated with using the scooter.

Your warranty coverage will not be voided if you choose to perform your own maintenance. However, you should have the proper tools and service information and be mechanically qualified. Failures that occur due directly to improper maintenance are not covered.

Almost all of your warranty coverage can be extended through the Honda Protection Plan (USA only). For more information, see your Honda dealer.



## Warranty Service

---

Please remember that recommended maintenance interval servicing is not included in your warranty coverage. Additionally, your warranty does not apply to the normal wear of items (such as brakes, tires, etc.).

If you believe you have a problem with your scooter, call the service department of your Honda dealer. Make an appointment for an inspection and diagnosis. Remember, as the owner of the scooter, you will be asked to authorize that inspection. Your dealer will give you the results of the inspection. If the problem is covered under warranty, your dealer will perform the warranty repairs for you.

If you have questions about warranty coverage or the nature of the repair, it is best to talk to the service manager of your Honda dealer.

Sometimes, in spite of the best intentions of all concerned, a misunderstanding may occur. If you aren't satisfied with your dealer's handling of the situation, we suggest you discuss your problem with the appropriate member of the dealership's management team. If the problem has already been reviewed with the Service Manager, Parts Manager, Sales Manager, etc., contact the Owner of the dealership or their designated representative.

## Contacting Honda

---

Your owner's manual was written to cover most of the questions you might ask about your Honda. Any questions not answered in the owner's manual can be answered by your Honda dealer. If your dealer doesn't have the answer right away, they will get it for you.

If you have a difference of opinion with your dealer, please remember that each dealership is independently owned and operated. That's why it's important to work to resolve any differences at the dealership level.

If you wish to comment on your experiences with your Honda or with your dealer, please send your comments to the following address (USA only):

Motorcycle Division, American Honda Motor Co., Inc., P.O. Box 2220, Torrance, CA 90509-2220, mailstop: 100-4W-5B, telephone: (310) 532-9811.

Canada: Refer to the Warranties Booklet that was supplied with your vehicle.

Please include the following information in your letter:

- name, address, and telephone number
- product model, year, and frame/VIN serial number
- date of purchase
- dealer name and address

We will likely ask your Honda dealer to respond, or possibly acknowledge your comments directly.

## Your Honda Dealer

---

Once you purchase your new Honda, get familiar with the organization of your Honda dealer so you can utilize the full range of services available.

The service department is there to perform regular maintenance and unexpected repairs. It has the latest available service information from Honda. The service department will also handle warranty inspections and repairs.

The parts department offers Genuine Honda parts, Pro Honda products, Hondaline accessories (USA only), and Honda accessories and products (Canada only). The same quality that went into your Honda can be found in Genuine Honda replacement parts. You'll also find comparable quality in the accessories and

products available from the parts department.

The sales department offers the Honda Protection Plan to extend almost all of your warranty coverage (USA only). Your Honda dealer can inform you about competition and other riding events in your area. You'll also find that your dealer is a source of information about American Honda's Rider Education Centers and the Honda Rider's Club of America (USA only).

We're sure you'll be as pleased with the service your Honda dealer continues to provide after the sale as you are with the quality and dependability of your Honda.

## The Honda Rider's Club (USA only)

---

One of the best ways to get the most enjoyment from owning and riding your Honda is through the Honda Rider's Club of America. Your purchase of a new motorcycle, scooter, ATV or PWC from a participating U.S. Honda dealer entitles you to a complimentary one-year membership in the Club. There are hundreds of HRCA Chapter sponsoring dealers across the USA with events and activities almost every weekend.

Membership benefits include:

- 24 hour, toll-free roadside assistance for your new Honda (includes roadside assistance for your transport vehicle as long as your Honda is aboard or in tow).
- Vehicle transport to the nearest Honda dealer or service center, if necessary.
- An exclusive HRCA website complete with access to the official Honda

Common Service Manual, contests, insider information and more.

- Reimbursement (up to \$75) for Motorcycle Safety Foundation training. Separate free training from the Specialty Vehicle Institute of America for ATV owners.
- One full year of the *Honda Red Rider* magazine or *Honda Red Rider ATV* (for ATV purchasers).
- Discounts from HRCA partners for experienced rider courses.
- Discounted vehicle insurance from the HRCA's insurance partner.
- Racing contingency programs and assistance at selected dual-sport, off-road, and motocross events.

Contact your Honda dealer for more information or call: 1 800-847-HRCA or log on to [www.hrca.honda.com](http://www.hrca.honda.com).

## Reporting Safety Defects (USA only)

---

If you believe that your vehicle has a defect which could cause a crash or could cause injury or death, you should immediately inform the National Highway Traffic Safety Administration (NHTSA) in addition to notifying American Honda Motor Co., Inc.

If NHTSA receives similar complaints, it may open an investigation, and if it finds that a safety defect exists in a group of vehicles, it may order a recall and remedy campaign. However, NHTSA cannot become involved in individual problems between you, your dealer, or American Honda Motor Co., Inc.

To contact NHTSA, you may either call the Auto Safety Hotline toll-free at 1-800-424-9393 (or 366-0123 in Washington, D.C. area) or write to: NHTSA, U.S. Department of Transportation, Washington, D.C. 20590.

You can also obtain other information about motor vehicle safety from the Hotline.



# Table of Contents

---

The following presents the contents of each section of your owner's manual.

<b>SCOOTER SAFETY.....</b>	<b>1</b>
Important Safety Information .....	2
Accessories & Modifications .....	5
Safety Labels .....	7
<b>INSTRUMENTS &amp; CONTROLS .....</b>	<b>9</b>
Component Locations .....	10
Gauges, Indicators & Displays.....	13
Multi-function Display.....	20
Coolant Temperature Meter .....	21
Fuel Gauge.....	23
Odometer/Tripmeter A & B.....	24
Digital Clock .....	25
Controls & Features	
Ignition Switch .....	28
Start Button.....	29
Engine Stop Switch .....	29

Headlight Dimmer Switch .....	30
Turn Signal Switch.....	30
Horn Button .....	31
RESET Button.....	31
MODE Button .....	31
Parking Brake Lock.....	32

## Table of Contents

<b>BEFORE RIDING.....</b>	<b>35</b>	<b>BASIC OPERATION &amp; RIDING.....</b>	<b>53</b>
Are You Ready to Ride ? .....	36	Safe Riding Precautions .....	54
Protective Apparel.....	36	Starting & Stopping the Engine .....	55
Rider Training .....	38	Preparation.....	55
Is Your Scooter Ready to Ride ? .....	40	Starting Procedure .....	56
Pre-ride Inspection .....	40	Flooded Engine.....	59
Load Limits & Guidelines.....	43	Bank Angle Sensor Ignition Cut-off	
Loading.....	43	System.....	59
Load Limits .....	44	How to Stop the Engine .....	60
Loading Guidelines .....	45	Riding.....	61
Cargo Compartments.....	47	Braking .....	68
Center Compartment .....	47	Parking.....	72
Left Fairing Compartment .....	49	Riding with a Passenger or Cargo.....	76
Right Fairing Compartment .....	50		
Comfort & Convenience .....	51		
Adjustable Backrest.....	51		
Trunk Light.....	52		

(cont'd)



# Table of Contents

---

## **SERVICING YOUR HONDA ..... 77**

### *Before You Service Your Honda*

The Importance of Maintenance .....	80
Maintenance Safety .....	81
Important Safety Precautions .....	82
Periodic Maintenance .....	84
Maintenance Schedule .....	86
Maintenance Record .....	91

### *Service Preparations*

Component Locations .....	93
Tool Kit .....	96
Owner's Manual Storage .....	97
Rear Cover Removal .....	98
Left Side Cover Removal .....	99
Right Side Cover Removal .....	101
Right Fairing Compartment Removal .....	103

### *Service Procedures*

#### Fluids & Filters

Fuel .....	104
Engine Oil, Filter & Strainer Screen ...	108
Coolant .....	118
Air Cleaner .....	122
Crankcase Breather .....	124

#### Engine

Throttle .....	125
Engine Idle Speed .....	127
Spark Plug .....	129

#### Chassis

Suspension .....	132
Brakes .....	135
Tires .....	142
Side Stand .....	149

## Table of Contents

---

### SERVICING YOUR HONDA (cont'd)

#### Electrical

Battery..... 150

Appearance Care ..... 155

**TIPS..... 163**

Storing Your Honda ..... 164

Transporting Your Scooter..... 167

You & the Environment ..... 168

### TAKING CARE OF THE

**UNEXPECTED ..... 169**

General Guidelines..... 170

If Your Engine Quits or Won't Start ... 171

If You Have a Flat Tire ..... 176

If Your Engine Overheats ..... 180

If the Low Oil Pressure Indicator

Lights ..... 182

If a Fuse Blows..... 183

If You Crash ..... 187

If You Lose Your Key ..... 188

If Your Battery is Low (or Dead) ..... 189

(cont'd)

# Table of Contents

---

<b>TECHNICAL INFORMATION .....</b>	<b>191</b>
Vehicle Identification.....	192
Specifications .....	195
Break-in Guidelines.....	201
Emission Control Systems .....	202
Catalytic Converter .....	208
Oxygenated Fuels .....	209

<b>CONSUMER INFORMATION .....</b>	<b>211</b>
Authorized Manuals .....	212
Warranty Coverage .....	215
Warranty Service .....	216
Contacting Honda.....	217
Your Honda Dealer .....	218
The Honda Rider's Club (USA only) .....	219
Reporting Safety Defects (USA only) .....	220
<b>TABLE OF CONTENTS .....</b>	<b>222</b>
<b>INDEX .....</b>	<b>228</b>

## **QUICK REFERENCE**



# Index

---

## A

accessories .....	5
air cleaner .....	122
air pressure,tires.....	142
American Honda, contacting.....	217
apparel, protective .....	36
appearance care .....	155
authorized manuals.....	212

## B

bank angle sensor .....	59
battery .....	150
brakes,	
fluid.....	137
pad wear.....	139
parking brake lever freeplay .....	141
braking .....	68

break-in guidelines .....	201
button,	
MODE .....	31
RESET .....	31

## C

capacity, fuel .....	106
care, appearance .....	155
catalytic converter .....	208
cleaning, appearance care .....	156
clock, digital .....	25
color label .....	194
compartment,	
center.....	47
left fairing.....	49
right fairing.....	50
storage.....	96, 97
component locations,	
gauges, indicators & controls.....	10

# Index

maintenance .....	93
consumer information .....	211
coolant.....	118
customer service .....	217

## D

defects, safety .....	220
digital clock .....	25
display,	
check .....	15
multi-function.....	20

## E

emission control systems.....	202
engine,	
flooded.....	59
idle speed .....	127
low oil pressure.....	182

number .....	193
oil .....	108
overheats.....	180
pinging .....	105
starting .....	55
stop switch .....	29
stopping.....	60
won't start .....	171
environment .....	168

## F

flat tire.....	176
flooded engine .....	59
frame number .....	193

(cont'd)

# Index

---

fuel,	
gauge.....	23
oxygenated.....	209
recommendation.....	104
tank capacity.....	106
fuses.....	183

## G

gasohol.....	209
gasoline.....	104
gauges, indicators & displays.....	13

## H

headlight dimmer switch.....	30
high beam indicator.....	13
holder hook.....	74
Honda,	
contacting.....	217

Rider's Club.....	219
dealer.....	218
Honda service manual.....	212
horn button.....	31

## I

identification, vehicle.....	192
idle speed, engine.....	127
ignition cutoff system,	
bank angle.....	59
side stand.....	55
ignition switch.....	28
indicators.....	13
inspection, pre-ride.....	40

## K

key, lost.....	188
kit, tool.....	96

## L

labels, safety .....	7
lamp check .....	14
left fairing compartment .....	49
left side cover removal .....	99
limit, weight .....	44
load limits .....	44
loading guidelines .....	45
location, components, gauges, indicators & controls .....	10
maintenance .....	93
lock, steering .....	73

## M

maintenance, importance .....	80
periodic .....	84

record .....	91
safety .....	81
schedule .....	86
manual, service .....	212
maximum weight limit .....	44
MODE button .....	31
modifications .....	6

## N

numbers, serial .....	192
-----------------------	-----

## O

odometer .....	24
oil, engine .....	108
low pressure .....	182

(cont'd)



# Index

---

operating controls .....	28
overheat, engine.....	180
owner's manual storage.....	97
oxygenated fuels.....	209

## P

parking .....	72
pinging, engine .....	105
plug, spark.....	129
pre-ride inspection .....	40
problems, unexpected.....	169
protective apparel .....	36

## R

rear brake lock .....	32
rear cover removal.....	98
removal, left side cover .....	99

rear cover .....	98
right fairing compartment .....	103
right side cover .....	101
reporting safety defects.....	220
RESET button.....	31
rider training .....	3, 38
Rider's Club, Honda.....	219
riding, basic operation.....	53
clothing .....	36
precautions.....	54
safety.....	2
safety precautions.....	54
with passenger or cargo.....	76
right fairing compartment .....	50, 103
right side cover removal.....	101

## S

- safety,
  - important precautions ..... 82
  - labels ..... 7
  - reporting defects ..... 220
  - riding precautions ..... 54
- schedule, maintenance ..... 86
- sensor, bank angle ..... 59
- serial numbers ..... 192
- service,
  - customer ..... 217
  - manuals ..... 212
  - warranty ..... 216
- side cover removal,
  - left ..... 99
  - right ..... 101
- side stand ..... 149
- side stand ignition cutoff system ..... 55
- spark knock ..... 105
- spark plug ..... 129
- specifications ..... 195
- speedometer ..... 13
- stand, side ..... 149
- start button ..... 29
- starting,
  - engine ..... 55
  - troubleshooting ..... 171
- steering lock ..... 73
- stop switch, engine ..... 29
- stopping engine ..... 60
- storage,
  - owner's manual ..... 97
  - scooter ..... 166
- switch,
  - engine stop ..... 29
  - headlight dimmer ..... 30
  - ignition ..... 28
  - turn signal ..... 30

# Index

---

## T

temperature meter, coolant.....	21
theft prevention tips.....	75
throttle.....	125
tires,	
air pressure.....	142
flat.....	176
replacing .....	146
tool kit.....	96
training, rider .....	3, 38
transporting your scooter.....	167
tripmeter.....	24
trouble, unexpected .....	169
troubleshooting, starting.....	171
turn signal indicator.....	13

## V

vehicle identification no. (VIN).....	192
---------------------------------------	-----

## W

warranty,	
coverage.....	215
extended.....	215
service .....	216
washing your scooter.....	157
weight limit.....	44





The following is a brief, but important collection of information you need to know about your Honda. You'll also find space to record important notes.

### How To Avoid Costly Repairs

The engine of your Honda can be the most expensive component to repair. Proper maintenance, especially the use of the recommended fluids and filters, prevents premature wear and damage.

Frequent causes of costly repairs are:

- Engine oil: insufficient quantity, improper oil.
- Air cleaner: dirty, leaking because of improper installation (poor seal).

Record important information on the following page:

## Quick Reference

---

VIN/Frame No.	
Engine No.	
Frame No.	
Ignition Key No.	
Color Label	
Owner's Name	
Address	
City/State	
Phone	
Dealer's Name	
Address	
City/State	
Phone	
Service Mgr.	

Quick Reference

## Quick Reference

Scheduled Maintenance	Initial: 600 miles (1,000 km) Regular: every 4,000 miles (6,400 km)
Pre-ride Inspection	Check the following items each time before you ride (page 40): tires, leaks, loose parts, brakes, indicators, lights.
Periodic Checks	Check the following items monthly (page 84 ): tires, fluids, lights, freeplay, fuses, nuts & bolts.
Fuel/Capacity	unleaded gasoline, pump octane number 86 or higher <b>4.23 US gal (16.0 ℓ)</b>
Engine Oil	API Service Classification SG or higher except oils labeled as energy conserving on the circular API service label, SAE 10W-40, JASO T 903 standard MA or MB, Pro Honda GN4, HP4 (without molybdenum additives) or HP4M (with molybdenum additives) 4-stroke oil or equivalent
Maximum Weight Capacity	<b>366 lbs (166 kg) USA</b> <b>375 lbs (170 kg) Canada</b> rider, passenger, all cargo and accessories



## Quick Reference

---

Tires	Front: 120/80-14M/C 58S BRIDGESTONE HOOP B03 IRC SS530F Rear: 150/70-13M/C 64S BRIDGESTONE HOOP B02 IRC SS530R Type: bias-ply, tubeless
Tire Pressure (cold)	Front: 29 psi (200 kPa , 2.00 kgf/cm <sup>2</sup> ) Rear: 33 psi (225 kPa , 2.25 kgf/cm <sup>2</sup> ) with less than 200 lbs (90 kg) of added weight 36 psi (250 kPa , 2.50 kgf/cm <sup>2</sup> ) with more than 200 lbs (90 kg) of added weight
Spark Plugs	standard: CR8EH-9 (NGK) or U24FER9 (DENSO)
Coolant	ethylene glycol antifreeze (silicate-free) for aluminum engines in 50/50 solution with Pro Honda HP Coolant or an equivalent distilled water
Fuses	main A: 30A main B: 30A other: FSC600D: 10A, 15A FSC600A: 10A, 15A, 30A

## Quick Reference