

This manual should be considered a permanent part of the motorcycle and should remain with the motorcycle when it is resold.

This Owner's Manual covers the INTERCEPTOR and INTERCEPTOR ABS models. You may find descriptions of equipment and features that are not on your particular model. All illustrations are based on the INTERCEPTOR ABS model.

This publication includes the latest production information available before printing. Honda Motor Co., Ltd. reserves the right to make changes at any time without notice and without incurring any obligation.

No part of this publication may be reproduced without written permission.

© 2005 Honda Motor Co., Ltd.

2006
Honda VFR800/A
INTERCEPTOR/ABS
OWNER'S MANUAL

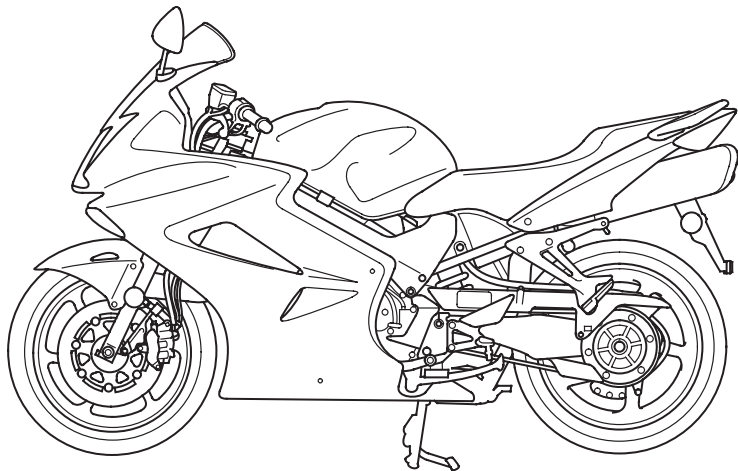

Introduction

Congratulations on choosing your Honda motorcycle.

When you own a Honda, you're part of a worldwide family of satisfied customers — people who appreciate Honda's reputation for building quality into every product.

Before riding, take time to get acquainted with your motorcycle and how it works. To protect your investment, we urge you to take responsibility for keeping your motorcycle well maintained. Scheduled service is a must, of course. But it's just as important to observe the break-in guidelines, and perform all pre-ride and other periodic checks detailed in this manual.

We also recommend that you read this owner's manual before you ride. It's full of facts, instructions, safety information, and helpful tips. To make it easy to use, the manual contains a detailed list of topics at the beginning of each section, and both an in-depth table of contents and an index at the back of the book.

As you read this manual, you will find information that is preceded by a **NOTICE** symbol. This information is intended to help you avoid damage to your Honda, other property, or the environment.

Read the Warranties Booklet (page 237) thoroughly so you understand the coverages that protect your new Honda and are aware of your rights and responsibilities.

If you have any questions, or if you ever need special service or repairs, remember that your Honda dealer knows your motorcycle best and is dedicated to your complete satisfaction.

Please report any change of address or ownership to your Honda dealer so we will be able to contact you concerning important production information.

You may also want to visit our website at www.honda.com.

Happy riding!

California Proposition 65 Warning

WARNING: This product contains or emits chemicals known to the State of California to cause cancer and birth defects or other reproductive harm.

A Few Words About Safety

Your safety, and the safety of others, is very important. And operating this motorcycle safely is an important responsibility.

To help you make informed decisions about safety, we have provided operating procedures and other information on labels and in this manual. This information alerts you to potential hazards that could hurt you or others.

Of course, it is not practical or possible to warn you about all hazards associated with operating or maintaining a motorcycle. You must use your own good judgment.

You will find important safety information in a variety of forms, including:

- **Safety Labels** — on the motorcycle.
- **Safety Messages** — preceded by a safety alert symbol  and one of three signal words: **DANGER**, **WARNING**, or **CAUTION**.

These signal words mean:

Safety Messages

A Few Words About Safety

DANGER

You **WILL** be **KILLED** or **SERIOUSLY HURT** if you don't follow instructions.

WARNING

You **CAN** be **KILLED** or **SERIOUSLY HURT** if you don't follow instructions.

CAUTION

You **CAN** be **HURT** if you don't follow instructions.

- **Safety Headings** — such as Important Safety Reminders or Important Safety Precautions.
- **Safety Section** — such as Motorcycle Safety.
- **Instructions** — how to use this motorcycle correctly and safely.

This entire manual is filled with important safety information — please read it carefully.

Contents

These pages give an overview of the contents of your owner's manual. The first page of each section lists the topics covered in that section.

Motorcycle Safety..... 1

Important safety information you should know, plus a look at the safety-related labels on your motorcycle.

Instruments & Controls..... 9

The location and function of indicators, gauges, and controls on your motorcycle and operating instructions for various controls and features.

Before Riding..... 41

The importance of wearing a helmet and other protective gear, how to make sure you and your motorcycle are ready to ride, and important information about loading.

Basic Operation & Riding 51

How to start and stop the engine, shift gears, and brake. Also, riding precautions and important information about riding with a passenger or cargo.

Servicing Your Honda 69

Why your motorcycle needs regular maintenance, what you need to know before servicing your Honda, an owner maintenance schedule, and instructions for specific maintenance and adjustment items.

Tips 175

How to store and transport your motorcycle and how to be an environmentally-responsible rider.

Taking Care of the Unexpected 181

What to do if you have a flat tire, your engine won't start, etc.

Technical Information 211

ID numbers, technical specifications, and other technical facts.

Consumer Information 233

Information on warranties, emission controls, how to get Honda service manuals, and...

“Reporting Safety Defects” 242

Table of Contents 244

Sequential listing of topics in this owner's manual.

Index 248

Quick Reference

Handy facts about fuel, engine oil, tire sizes, and air pressures.

Motorcycle Safety

This section presents some of the most important information and recommendations to help you ride your motorcycle safely. Please take a few moments to read these pages. This section also includes information about the location of safety labels on your motorcycle.

Important Safety Information	2
Accessories & Modifications	5
Safety Labels	7

Important Safety Information

Your motorcycle can provide many years of service and pleasure — if you take responsibility for your own safety and understand the challenges you can meet while riding.

There is much that you can do to protect yourself when you ride. You'll find many helpful recommendations throughout this manual. The following are a few that we consider most important.

Always Wear a Helmet

It's a proven fact: helmets significantly reduce the number and severity of head injuries. So always wear an approved motorcycle helmet and make sure your passenger does the same. We also recommend that you wear eye protection, sturdy boots, gloves, and other protective gear (page 42).

Important Safety Information

Take Time to Learn & Practice

Even if you have ridden other motorcycles, take time to become familiar with how this motorcycle works and handles. Practice in a safe area until you build your skills and get accustomed to the motorcycle's size and weight.

Because many accidents involve inexperienced or untrained riders, we urge all riders to take a certified course approved by the Motorcycle Safety Foundation (MSF). See page 44.

Ride Defensively

The most frequent motorcycle collision happens when a car turns left in front of a motorcycle. Another common situation is a car moving suddenly into your lane.

Always pay attention to other vehicles around you, and do not assume that other drivers see you. Be prepared to stop quickly or make an evasive maneuver. For other riding tips, see the booklet, *You and Your Motorcycle: Riding Tips and Practice Guide*, which came with your new motorcycle (USA only).

Make Yourself Easy to See

Some drivers do not see motorcycles because they are not looking for them. To make yourself more visible, wear bright reflective clothing, position yourself so other drivers can see you, signal before turning or changing lanes, and use your horn when it will help others notice you.

Important Safety Information

Ride within Your Limits

Pushing limits is another major cause of motorcycle accidents. Never ride beyond your personal abilities or faster than conditions warrant. Remember that alcohol, drugs, fatigue, and inattention can significantly reduce your ability to make good judgments and ride safely.

Don't Drink and Ride

Alcohol and riding don't mix. Even one drink can reduce your ability to respond to changing conditions, and your reaction time gets worse with every additional drink. So don't drink and ride, and don't let your friends drink and ride either.

Keep Your Honda in Safe Condition

It's important to keep your motorcycle properly maintained and in safe riding condition. To help avoid problems, inspect your motorcycle before every ride and perform all recommended maintenance. Never exceed load limits (page 49), and do not modify your motorcycle (page 6) or install accessories that would make your motorcycle unsafe (page 5).

Modifying your motorcycle or using non-Honda accessories can make your motorcycle unsafe. Before you consider making any modifications or adding an accessory, be sure to read the following information.

⚠ WARNING

Improper accessories or modifications can cause a crash in which you can be seriously hurt or killed.

Follow all instructions in this owner's manual regarding accessories and modifications.

Accessories

We strongly recommend that you use only genuine Honda accessories that have been specifically designed and tested for your motorcycle. Because Honda cannot test all other accessories, you must be personally responsible for proper selection, installation, and use of non-Honda accessories.

Check with your Honda dealer for assistance and always follow these guidelines:

- Make sure the accessory does not obscure any lights, reduce ground clearance and lean angle, limit suspension travel or steering travel, alter your riding position, or interfere with operating any controls. (cont'd)

Accessories & Modifications

- Do not add any electrical equipment that will exceed the motorcycle's electrical system capacity (page 219). A blown fuse can cause a loss of lights or engine power (page 202).
- Do not pull a trailer or sidecar with your motorcycle. This motorcycle was not designed for these attachments, and their use can seriously impair your motorcycle's handling.

Modifications

We strongly advise you not to remove any original equipment or modify your motorcycle in any way that would change its design or operation. Such changes could seriously impair your motorcycle's handling, stability, and braking, making it unsafe to ride.

Removing or modifying your lights, exhaust system, emission control system, or other equipment can also make your motorcycle illegal.

Safety Labels

Safety labels on your motorcycle either warn you of potential hazards that could cause serious injury or they provide important safety information. Read these labels carefully and don't remove them.

If a label comes off or becomes hard to read, contact your Honda dealer for a replacement.

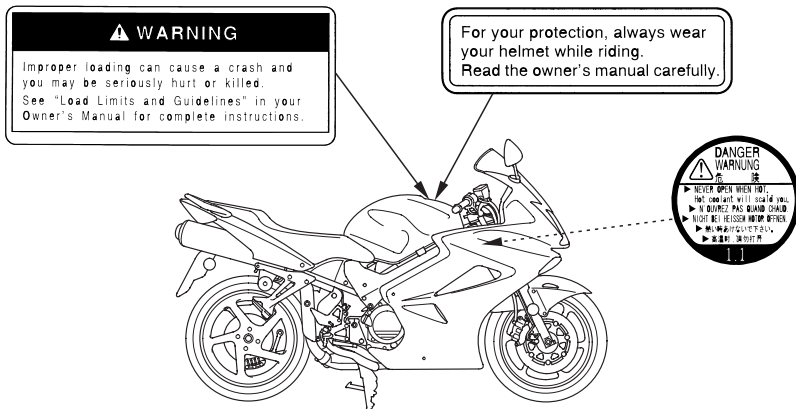

Safety Labels

< For USA >

TIRE INFORMATION	
COLD TIRE PRESSURES:	
[UP TO MAXIMUM WEIGHT CAPACITY]	FRONT 250kPa 2.50kgf/cm ² 36psi. REAR 290kPa 2.90kgf/cm ² 42psi.
[UP TO 90kg(200lbs.) LOAD]	FRONT 250kPa 2.50kgf/cm ² 36psi. REAR 290kPa 2.90kgf/cm ² 42psi.
MAXIMUM WEIGHT CAPACITY: 181 kg (399 lbs.)	
TIRE SIZE: FRONT120/70ZR17M/C(58W) REAR180/55ZR17M/C(73W)	
TIRE BRAND	FRONT REAR
BRIDGESTONE	B1020F BB B1020R BB
DUNLOP	D204FK D204K
METZELER	MEZ4A FRONT MEZ4A
MIN. RECOMMEND TIRE CENTER TREAD DEPTH	
FRONT 1.5mm(0.06in.) REAR 2.0mm(0.08in.)	
<i>Read Owner's Manual</i>	
THIS MOTORCYCLE IS EQUIPPED WITH TUBELESS TIRES.	

< For CANADA >

TIRE INFORMATION	
COLD TIRE PRESSURES:	
[UP TO MAXIMUM WEIGHT CAPACITY]	FRONT 250kPa 2.50kgf/cm ² 36psi. REAR 290kPa 2.90kgf/cm ² 42psi.
[UP TO 90kg(200lbs.) LOAD]	FRONT 250kPa 2.50kgf/cm ² 36psi. REAR 290kPa 2.90kgf/cm ² 42psi.
MAXIMUM WEIGHT CAPACITY: 185 kg (408 lbs.)	
TIRE SIZE: FRONT120/70ZR17M/C(58W) REAR180/55ZR17M/C(73W)	
TIRE BRAND	FRONT REAR
BRIDGESTONE	B1020F BB B1020R BB
DUNLOP	D204FK D204K
METZELER	MEZ4A FRONT MEZ4A
MIN. RECOMMEND TIRE CENTER TREAD DEPTH	
FRONT 1.5mm(0.06in.) REAR 2.0mm(0.08in.)	
<i>Read Owner's Manual</i>	
THIS MOTORCYCLE IS EQUIPPED WITH TUBELESS TIRES.	

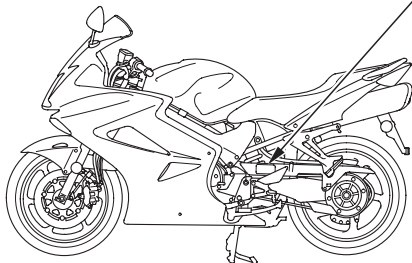

Instruments & Controls

This section shows the location of all gauges, indicators, and controls you would normally use before or while riding your motorcycle.

The items listed on this page are described in this section. Instructions for other components are presented in other sections of this manual where they will be most useful.

Operation Component Locations	11
Gauges, Indicators & Displays.....	14
Multi-function Display	24
Fuel Gauge.....	25
Coolant Temperature Meter	26
Air Temperature Meter	28
Speedometer	30
Odometer	30
Tripmeter A & B	31
Changing the Speed and Mileage Unit	32
Digital Clock	33

(cont'd)

Instruments & Controls

Controls & Features

Ignition Switch	35
Start Button.....	36
Engine Stop Switch	36
Hazard Switch	37
Headlight Dimmer Switch	38
Turn Signal Switch.....	38
Horn Button	39
SELECT Button	39
RESET Button.....	39

Operation Component Locations

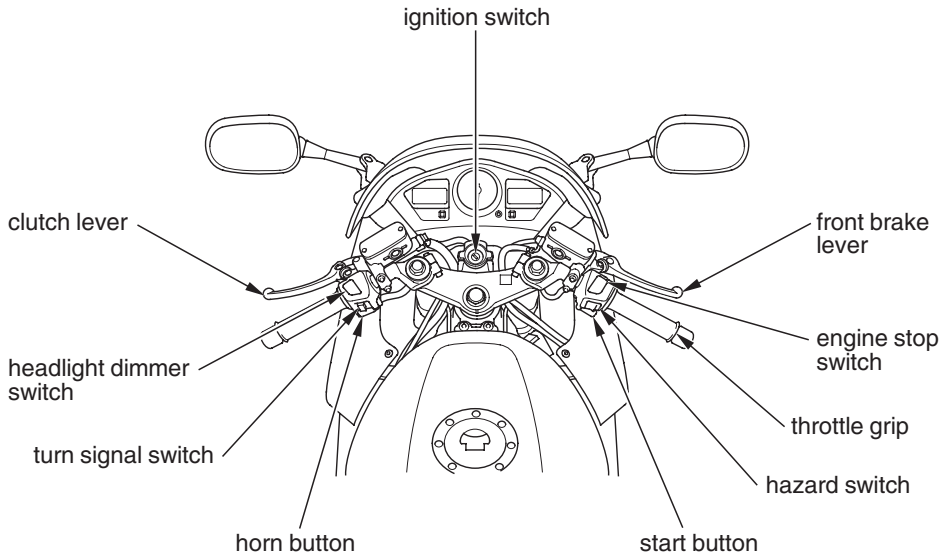

Operation Component Locations

storage compartment for
U-shaped lock

helmet holder

rear brake pedal

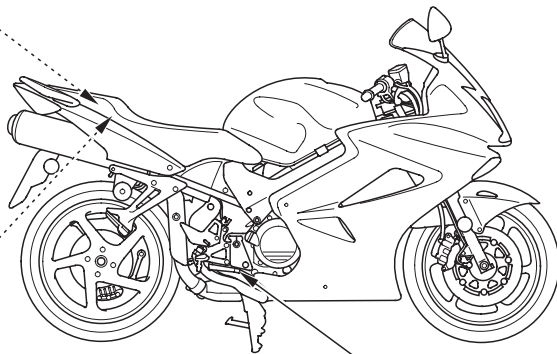

Operation Component Locations

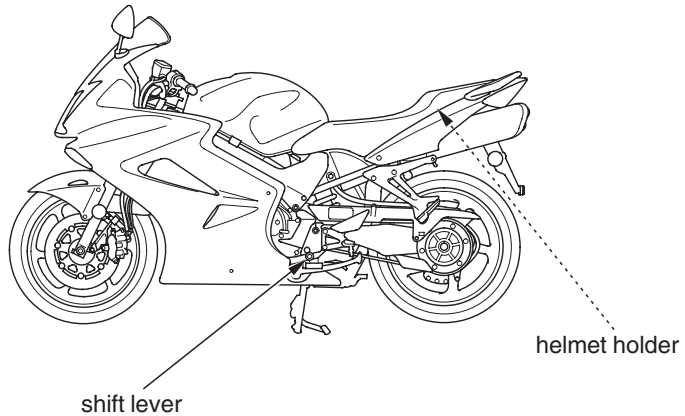

Gauges, Indicators & Displays

The gauges, indicators and displays on your motorcycle keep you informed, alert you to possible problems, and make your riding safer and more enjoyable. Refer to the gauges, indicators and displays frequently. Their functions are described on the following pages.

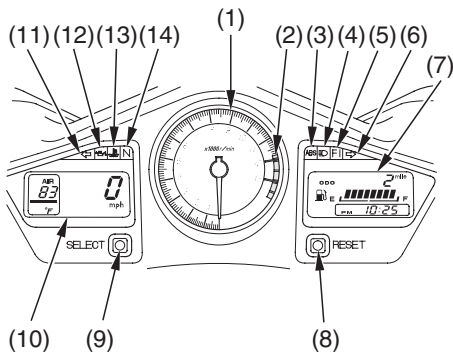

- (1) tachometer
- (2) tachometer red zone
- (3) anti-lock brake system (ABS) indicator
(INTERCEPTOR ABS only)
- (4) high beam indicator
- (5) PGM-FI malfunction indicator lamp (MIL)
- (6) right turn signal indicator
- (7) right multi-function display
- (8) RESET button
- (9) SELECT button
- (10) left multi-function display
- (11) left turn signal indicator
- (12) low oil pressure indicator
- (13) coolant temperature indicator
- (14) neutral indicator

Gauges, Indicators & Displays

Lamp Check

The low oil pressure indicator comes on when you turn the ignition switch ON so you can check that it is working. The indicator remains on until after the engine is started.

The PGM-FI malfunction indicator lamp lights for a few seconds and then goes off when you turn the ignition switch ON.

(INTERCEPTOR ABS only)

The anti-lock brake system (ABS) indicator comes on when you turn the ignition switch ON. This indicator goes off after you ride the motorcycle at a speed above 6 mph (10 km/h).

When applicable, the high beam and neutral indicators come on when you turn the ignition switch ON and remain on until you select the low beam or shift out of neutral.

These indicators are identified in the table on pages 18 – 23 with the words: *Lamp Check*.

If one of these indicators does not come on when it should, have your Honda dealer check for burned-out bulbs or other problems.

Gauges, Indicators & Displays

Display Check

When the ignition switch is turned ON, the left multi-function display (1) and right multi-function display (2) will temporarily show all the modes and digital segments so you can make sure the liquid crystal display is functioning properly. (Except digital clock)

The displays are identified in the table on pages 20 – 22 with the words: *Display Check*.

If any part of these displays does not come on when it should, have your Honda dealer check for problems.

Gauges, Indicators & Displays

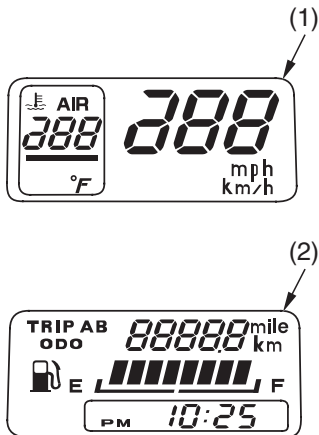

- (1) left multi-function display
- (2) right multi-function display

Gauges, Indicators & Displays

1	tachometer	Shows engine speed in revolutions per minute (rpm).
2	tachometer red zone	Shows excessive engine rpm range (indicated from the beginning of the tachometer red zone) in which operation may damage the engine. Do not let the tachometer needle enter the red zone.
3	anti-lock brake system (ABS) indicator (red) (INTERCEPTOR ABS)	Lights when there is any abnormality in the anti-lock brake system (ABS). Normally, this indicator comes on when the ignition switch is turned ON, and goes off after you ride the motorcycle at a speed above 6 mph (10 km/h). If the indicator comes on while riding, stop the motorcycle in a safe place and turn off the engine. Refer to <i>ABS Indicator</i> , page 62 . For information about ABS, see page 61 . <i>Lamp Check</i> .
4	high beam indicator (blue)	Lights when the headlight is on high beam.

Gauges, Indicators & Displays

5	PGM-FI malfunction indicator lamp (MIL) (red)	Flashes when there is any abnormality in the PGM-FI (Programmed Fuel Injection) system. Should also light for a few seconds and then go off when the ignition switch is turned ON and the engine stop switch is at RUN. If the indicator comes on at any other time, reduce speed and take your motorcycle to a Honda dealer as soon as possible. <i>Lamp Check.</i>
6	right turn signal indicator (amber)	Flashes when the right turn signal operates.

Gauges, Indicators & Displays

7	right multi-function display	The display includes the following functions: <i>Display Check.</i>
	tripmeter A & B	Shows the number of miles or kilometers ridden since you last reset the meter. The tripmeter has two sub modes, “A” and “B.” To zero (0) the tripmeter, press the RESET button (page 31).
	odometer	Shows the total miles or kilometers ridden (page 30).
	fuel gauge	Shows approximate fuel supply available (page 25). When segment F comes on, the fuel tank capacity is: 5.81 US gal (22.0 ℓ) When segment E flashes while riding, fuel reserved in the tank is about: 0.92 US gal (3.5 ℓ)
	digital clock	Shows hour and minute (page 33).

Gauges, Indicators & Displays

8	RESET button	Selects odometer and tripmeter A or B and resets the tripmeter to zero (0) (page 31). Also used to set the digital clock (page 33).
9	SELECT button	Selects coolant or air temperature meter (page 26) and changes speed and mileage units for the speedometer/odometer/tripmeter (page 32). Also used to set the digital clock (page 33).

Gauges, Indicators & Displays

10	left multi-function display	The display includes the following functions: <i>Display Check.</i>
	speedometer	Shows riding speed in miles or kilometers per hour (page 30).
	coolant temperature meter	Shows engine coolant temperature digitally (page 26). USA: Fahrenheit (°F), Canada: Centigrade (°C). If the display begins to flash and a red bar appears on the display, pull safely to the side of the road. See page 199 for instructions and cautions.
	air temperature meter	Shows air (ambient) temperature (page 28). USA : Fahrenheit (°F), Canada : Centigrade (°C).

Gauges, Indicators & Displays

11	left turn signal indicator (amber)	Flashes when the left turn signal operates.
12	low oil pressure indicator (red)	Lights when engine oil pressure is low enough to cause engine damage. If the low oil pressure indicator lights during operation, pull safely to the side of the road. See page 201 for instructions and cautions. <i>Lamp Check</i> .
13	coolant temperature indicator (red)	Lights when the coolant is over the specified temperature. If the indicator comes on, pull safely to the side of the road. See pages 199 – 200 for instructions and cautions.
14	neutral indicator (green)	Lights when the transmission is in neutral.

Gauges, Indicators & Displays

Multi-function Display

The left multi-function display (1) includes the following functions:
coolant/air temperature meter
speedometer

The right multi-function display (4) includes the following functions:
odometer/tripmeter
fuel gauge
digital clock

Both the digital clock and tripmeter will reset if the battery is disconnected.

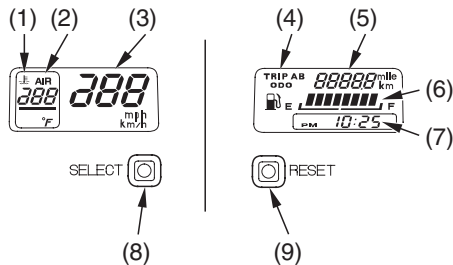

- (1) left multi-function display
- (2) coolant/air temperature meter
- (3) speedometer
- (4) right multi-function display
- (5) odometer/tripmeter
- (6) fuel gauge
- (7) digital clock
- (8) SELECT button
- (9) RESET button

Fuel Gauge

The fuel gauge liquid crystal display (1) shows the approximate fuel supply available in a graduated display. When segment F (2) goes on, the fuel tank capacity is:

5.81 US gal (22.0 l)

When segment E (3) flashes, you should refill the tank as soon as possible.

The amount of fuel remaining when the flashing starts is approximately:

0.92 US gal (3.5 l)

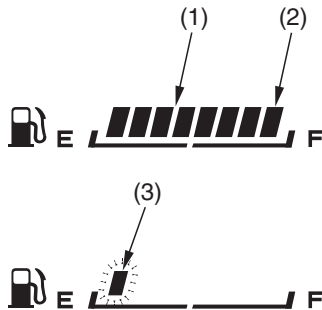

- (1) fuel gauge display
- (2) segment F
- (3) segment E

Gauges, Indicators & Displays

Coolant Temperature Meter

The coolant temperature meter (1) shows the coolant temperature digitally.

USA : Fahrenheit (°F),
Canada : Centigrade (°C).

If the air temperature is displayed, push the SELECT button (4) to display the coolant temperature.

Temperature Display

Below 94 °F (34 °C)	“--” is displayed
Between 95 °F – 270 °F (35 °C – 132 °C)	Actual coolant temperature is displayed
Above 270 °F (132 °C)	The display remains “270 °F (132 °C)”

< For USA >

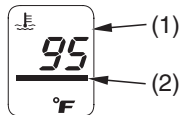

< For Canada >

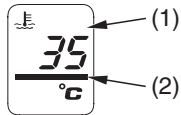

- (1) coolant temperature meter
- (2) black bar

Gauges, Indicators & Displays

Overheating Message:

When the coolant temperature reaches 251°F (122°C), the numbers in the temperature display start flashing and the black bar (2) under the numbers becomes a red bar (3).

At the same time, the coolant temperature indicator (5) lights.

If this occurs, stop the engine and check the reserve tank coolant level. Read pages 114 – 117 and do not ride the motorcycle until the problem has been corrected.

If the coolant temperature reaches 251°F (122°C) while the air temperature display is selected, the display will automatically switch to coolant temperature.

NOTICE

Continuing to ride with an overheated engine can cause serious engine damage.

< For USA >

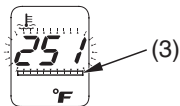

< For Canada >

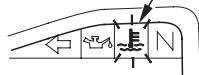
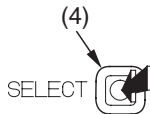
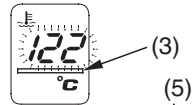

- (3) red bar
- (4) SELECT button
- (5) coolant temperature indicator

Gauges, Indicators & Displays

Air Temperature Meter

The air temperature meter (1) shows the air temperature digitally.

USA : Fahrenheit (°F),
Canada : Centigrade (°C).

If the coolant temperature is displayed, push the SELECT button (2) to display the air temperature.

Temperature Display

Below 13°F (-11°C)	“--” is displayed
Between 14°F - 122°F (-10°C - 50°C)	Actual air temperature is indicated
Above 122°F (50°C)	The display will remain “122°F (50°C)”

The temperature sensor is located in the upper fairing. Therefore, the temperature reading can be affected by heat reflection from the road surface, engine heat, and the exhaust from the surrounding traffic. This can cause an error in the temperature reading when your speed is under 19 mph (30 km/h).

Gauges, Indicators & Displays

< For USA >

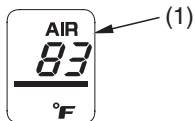

< For Canada >

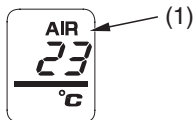

(1) air temperature meter

(2) SELECT button

Gauges, Indicators & Displays

Speedometer

The speedometer (1) shows riding speed in miles or kilometers per hour.

The speedometer will show ‘mph’ (USA) or ‘km/h’ (Canada) when the battery is reconnected.

Odometer

The odometer (2) shows the total miles or kilometers ridden.

This meter can display from 0 to 99,999 miles (kilometers). If the display exceeds 99,999 miles (kilometers), it will return to 0 automatically.

However, you may check the complete odometer reading when the ignition switch is turned ON. The missing sixth digit (indicating hundreds of thousands of miles or kilometers) will display by itself for 0.75 seconds. Then, the odometer will display the maximum 5 digits.

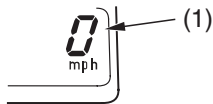

Example: the case of 123,000 miles run.

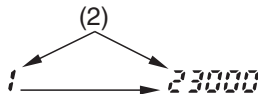

- (1) speedometer
- (2) odometer

Tripmeter A & B

The tripmeter shows number of miles or kilometers ridden since you last reset the meter.

The tripmeter has two sub modes, A (3) and B (4).

Push the RESET button (5) to switch between the odometer (2), tripmeter A (3) and tripmeter B (4).

To reset the tripmeter, push and hold the RESET button (5) with the display in the tripmeter A or B mode.

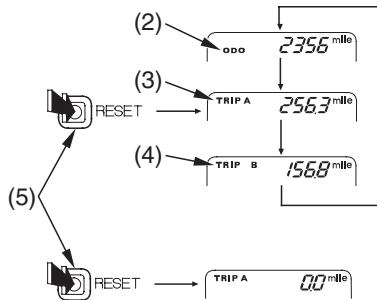

- (3) tripmeter A
- (4) tripmeter B
- (5) RESET button

Gauges, Indicators & Displays

Changing the Speed and Mileage Unit

The speedometer displays both “mph” and “km/h.”

The odometer/tripmeter displays both “mile” and “km.”

Press and hold the SELECT button (1) to select “mph”/“mile” and “km/h”/“km.”

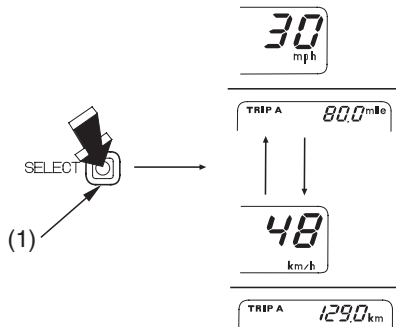

(1) SELECT button

Digital Clock

Shows hour and minute. To adjust the time, proceed as follows:

1. Turn the ignition switch ON.
2. Push and hold both the SELECT button (2) and RESET button (3) for more than 2 seconds. The digital clock (1) will be set in the adjust mode with the display flashing.

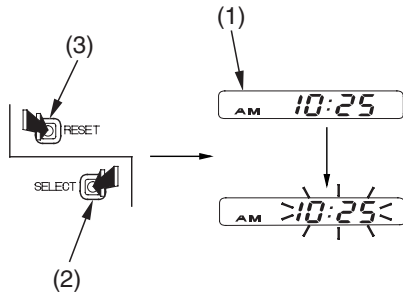

- (1) digital clock
- (2) SELECT button
- (3) RESET button

Gauges, Indicators & Displays

3. Push the RESET button until the desired time and AM/PM are displayed.
- The time is advanced by one minute, each time the button is pushed.
 - The time is advanced by ten minutes, when the button is pushed and held.

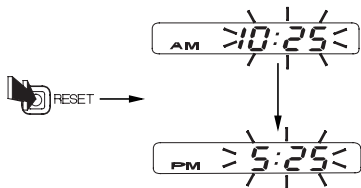

4. To end the adjustment, press the RESET button 5 seconds after the last adjustment, or turn the ignition switch OFF.

Ignition Switch

The ignition switch (1) is used for starting and stopping the engine (page 53) and to lock the steering for theft prevention (page 64). Insert the key and turn it to the right for the ON position. Push down on the key and turn it to the left to the LOCK (steering lock) position.

FRONT

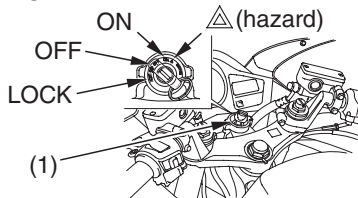

(1) ignition switch

Key Position	Function
△ (hazard)	When the hazard switch is ON, both the left and right turn signals flash. Engine and lights cannot be operated.
ON	Electrical circuits on.
OFF	No electrical circuits function.
LOCK (steering lock)	No electrical circuits function. Locks the steering head.

To unlock the steering lock, insert and push down on the key and turn it to the right to the OFF position.

Controls & Features

Start Button



The start button (1) is used for starting the engine. Pushing the button in starts the engine. See *Starting Procedure*, page 54.

When the start button is pushed, the starter motor will crank the engine; the headlight will automatically go out, but the taillight will stay on.

The starter motor will not operate if the engine stop switch is in the OFF position or the ignition switch is in the  (hazard) position when the start button is pushed.

Engine Stop Switch



RIGHT HANDLEBAR

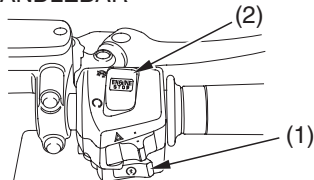

(1) start button

(2) engine stop switch



The engine stop switch (2) is used to stop the engine in an emergency. To operate, push the switch to the OFF position. The switch must be in the RUN position to start the engine, and it should normally remain in the RUN position even when the engine is OFF.

If your motorcycle is stopped with the ignition switch ON and the engine stop switch OFF, the headlight and taillight will remain on, resulting in battery discharge.

Hazard Switch



The hazard switch (3) should be used only when the motorcycle is stopped under emergency or hazardous condition.

To operate, turn the ignition key to the ON or  (hazard) position, and slide the hazard switch. The front and rear turn signals will blink simultaneously until you slide the switch again.

Be sure to turn the switch off when the hazard warning is no longer required, or the turn signals will not work properly, and may confuse other drivers.

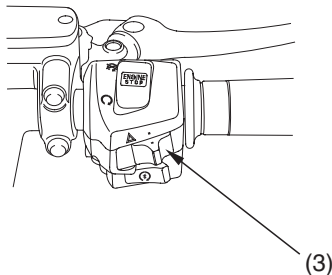

(3) hazard switch

Controls & Features

Headlight Dimmer Switch



The headlight dimmer switch (1) is used to change between the high and low beams of the headlight. To operate, turn the switch to HI for high beam, LO for low beam.

Turn Signal Switch

The turn signal switch (2) is used to signal a turn or a lane change. To operate, move the switch all the way in the proper direction and release it. The appropriate turn signal lights will start blinking. To cancel the light, push the switch in.

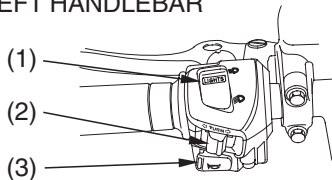
LEFT HANDLEBAR



- (1) headlight dimmer switch  HI
 LO
- (2) turn signal switch
- (3) horn button

Horn Button

The horn is used to alert other motorists. To operate, push the horn button (3).

SELECT Button

The SELECT button is used to switch between the coolant and air temperature displays. To operate, press the button.

The SELECT button is also used to change the speed and mileage units for the speedometer/odometer/tripmeter. To change the unit, press and hold the button (page 32).

The SELECT button is also used to set the digital clock (page 33).

RESET Button

The RESET button is used to switch between the odometer and the two tripmeter (A & B) displays. To operate, press the button.

To reset (zero) either tripmeter, press and hold the button for about 2—3 seconds until the display changes to zero.

The RESET button is also used to set the digital clock (page 33).

Before Riding

Before each ride, you need to make sure you and your Honda are both ready to ride. To help get you prepared, this section discusses how to evaluate your riding readiness, what items you should check on your motorcycle, and adjustments to make for your comfort, convenience, or safety. This section also includes important information about loading.

For information about adjusting the suspension on your Honda, see page 134.

Are You Ready to Ride ?	42
Protective Apparel.....	42
Rider Training	44
Is Your Motorcycle Ready to Ride ?	45
Pre-ride Inspection	45
Load Limits & Guidelines.....	48
Loading	48
Load Limits	49
Loading Guidelines	49

Are You Ready to Ride?

Before you ride your motorcycle for the first time, we urge you to:

- Read this owner's manual.
- Make sure you understand all the safety messages.
- Know how to operate all the controls.

Before each ride, be sure:

- You feel well and are in good physical and mental condition.
- You are wearing an approved motorcycle helmet (with chin strap tightened securely), eye protection, and other protective clothing.
- You don't have any alcohol or drugs in your system.

Make sure your passenger is ready to ride, too, and is wearing proper gear including a helmet.

If you must carry an extra helmet while riding, use a commercially-available elastic cord, strap, or net to secure the helmet to the seat.

Protective Apparel

For your safety, we strongly recommend that you always wear an approved motorcycle helmet, eye protection, boots, gloves, long pants, and a long-sleeved shirt or jacket whenever you ride.

Although complete protection is not possible, wearing proper gear can reduce the chance of injury when you ride.

Following are suggestions to help you choose the proper gear.

Are You Ready to Ride?

Helmets and Eye Protection

Your helmet is your most important piece of riding gear because it offers the best protection against head injuries. A helmet should fit your head comfortably and securely. A bright-colored helmet and reflective strips can make you more noticeable in traffic.

An open-face helmet offers some protection, but a full-face helmet offers more. Regardless of the style, look for a DOT (Department of Transportation) sticker in any helmet you buy (USA only). Always wear a face shield or goggles to protect your eyes and help your vision.

⚠ WARNING

Not wearing a helmet increases the chance of serious injury or death in a crash.

Be sure you and your passenger always wear a helmet, eye protection, and other protective apparel when you ride.

Additional Riding Gear

In addition to a helmet and eye protection, we also recommend:

- Sturdy boots with non-slip soles to help protect your feet and ankles.
- Leather gloves to help protect your hands.

(cont'd)

Are You Ready to Ride?

- A motorcycle riding suit or jacket for comfort as well as protection. Bright-colored and reflective clothing can help make you more noticeable in traffic. Avoid loose clothes that could get caught on any part of your motorcycle.

Rider Training

Developing your riding skills is an ongoing process. Even if you have ridden other motorcycles, take time to become familiar with how this motorcycle works and handles. Practice riding the motorcycle in a safe area to build your skills. Do not ride in traffic until you get accustomed to the motorcycle's controls, and feel comfortable with its size and weight.

We urge all riders to take a certified course approved by the Motorcycle Safety Foundation (MSF). New riders should start with the basic course, and even experienced riders will find the advanced course beneficial. For information about the MSF training course nearest you, call the national toll-free number: (800) 446-9227.

Other riding tips can be found in the *Riding Tips* booklet that came with your motorcycle (USA only).

Is Your Motorcycle Ready to Ride?

Before each ride, it's important to inspect your motorcycle and make sure any problem you find is corrected. A pre-ride inspection is a must, not only for safety, but because having a breakdown, or even a flat tire, can be a major inconvenience.

WARNING

Improperly maintaining this motorcycle or failing to correct a problem before riding can cause a crash in which you can be seriously hurt or killed.

Always perform a pre-ride inspection before every ride and correct any problems.

Pre-ride Inspection

Check the following items before you get on the motorcycle:

Tires & Wheels Look at the tires. If a tire appears low, use an air pressure gauge to check its pressure. Also look for signs of excessive wear (page 149) or damage to the tires and wheels.

Chain Check the condition of the chain. Adjust slack and lubricate as needed (page 156).

(cont'd)

Is Your Motorcycle Ready to Ride?

*Leaks,
Loose
Parts*

Walk around your motorcycle and look for anything that appears unusual, such as a leak or loose cable.

Lights

Make sure the headlight, brakelight, taillight, and turn signals are working properly.

If you are carrying a passenger or cargo, also check the following:

Load Limits Make sure you do not exceed the load limits (page 49).

Cargo Check that all cargo is secure.

Adjustments Adjust the suspension (pages 135, 137) according to your load.

Is Your Motorcycle Ready to Ride?

Check these items after you get on the motorcycle:

Throttle Rotate the throttle to check it moves smoothly without binding.

Brakes Pull the brake lever and press on the brake pedal to check that they operate normally.

Indicators Turn the ignition on and check for normal operation of the indicators (page 14).

If you haven't ridden the motorcycle in over a week, you should also check other items, such as the oil level and other fluids. See *Periodic Maintenance* (page 76). Periodic maintenance should also be done at least once a month, no matter how often you ride.

Remember, be sure to take care of any problem you find, or have your Honda dealer correct it before you ride.

Load Limits & Guidelines

Your motorcycle has been designed to carry you and one passenger. When you carry a passenger, you may feel some difference during acceleration and braking. But so long as you keep your motorcycle well-maintained, with good tires and brakes, you can safely carry loads within the given limits and guidelines.

However, exceeding the weight limit or carrying an unbalanced load can seriously impair your motorcycle's handling, braking, and stability. Non-Honda accessories, improper modifications, and poor maintenance can also reduce your safety margin.

Loading

How much weight you put on your motorcycle, and how you load it, are important to your safety. Anytime you ride with a passenger or cargo, you should be aware of the following information.

WARNING

Overloading or improper loading can cause a crash and you can be seriously hurt or killed.

Follow all load limits and other loading guidelines in this manual.

Load Limits & Guidelines

Load Limits

Following are the load limits for your motorcycle:

maximum weight capacity:

399 lbs (181 kg)

408 lbs (185 kg) (Canada only)

includes the weight of the rider, passenger, all cargo, and all accessories.

maximum cargo weight:

77 lbs (35 kg)

The weight of added accessories will reduce the maximum cargo weight you can carry.

Loading Guidelines

Your motorcycle is primarily intended for transporting you and a passenger. You may wish to secure a jacket or other small items to the seat when you are not riding with a passenger.

If you wish to carry more cargo, check with your Honda dealer for advice, and be sure to read the information regarding accessories on page 5 .

Improperly loading your motorcycle can affect its stability and handling. Even if your motorcycle is properly loaded, you should ride at reduced speeds and never exceed 80 mph (130 km/h) when carrying cargo.

Load Limits & Guidelines

Follow these guidelines whenever you carry a passenger or cargo:

- Check that both tires are properly inflated (page 147).
- If you change your normal load, you may need to adjust the front suspension (page 135) and the rear suspension (page 137).
- To prevent loose items from creating a hazard, make sure that all cargo is tied down securely before you ride.
- Place cargo weight as low and close to the center of your motorcycle as possible.
- Balance cargo weight evenly on both sides.

Basic Operation & Riding

This section gives basic riding instructions, including how to start and stop your engine, and how to use the throttle, clutch, and brakes. It also provides important information on riding with a passenger or cargo.

To protect your new engine and enjoy optimum performance and service life, refer to Break-in Guidelines (page 222).

To protect the catalytic converter in your motorcycle's exhaust system, avoid extended idling and the use of leaded gasoline.

Safe Riding Precautions	52
Starting & Stopping the Engine	53
Preparation.....	53
Starting Procedure	54
Flooded Engine.....	55
Bank Angle Sensor Ignition Cut-off System.....	55
How to Stop the Engine	56
Shifting Gears.....	57
Braking	59
Anti-lock Brake System (ABS) (INTERCEPTOR ABS)	61
ABS Indicator (INTERCEPTOR ABS)	62
Parking	63
Riding with a Passenger or Cargo.....	68

Safe Riding Precautions

Before riding your motorcycle for the first time, please review the *Motorcycle Safety* section beginning on page 1, and the *Before Riding* section beginning on page 41 .

Even if you have ridden other motorcycles, take time to become familiar with how this motorcycle works and handles. Practice in a safe area until you build your skills and get accustomed to the motorcycle's size and weight.

Make sure flammable materials such as dry grass or leaves do not come in contact with the exhaust system when riding, idling, or parking your motorcycle.

Starting & Stopping the Engine

Always follow the proper starting procedure described below.

For your safety, avoid starting or operating the engine in an enclosed area such as a garage. Your motorcycle's exhaust contains poisonous carbon monoxide gas which can collect rapidly in an enclosed area and cause illness or death.

Your motorcycle can be started with the transmission in gear by pulling in the clutch lever before operating the starter.

Your motorcycle is equipped with a side stand ignition cut-off system. If the side stand is down—the engine cannot be started unless the transmission is in neutral. If the side stand is up—the engine can be started in neutral, or in gear with the

clutch lever pulled in. After starting with the side stand down, the engine will stop if the transmission is put in gear before raising the side stand.

Preparation

Before starting, insert the key, turn the ignition switch ON, and confirm the following:

- The transmission is in NEUTRAL (neutral indicator light ON).
- The engine stop switch is set to RUN.
- The low oil pressure indicator is ON.
- The PGM-FI indicator is OFF.

Starting & Stopping the Engine

The low oil pressure indicator should go off a few seconds after the engine starts. If the low oil pressure indicator lights during operation, stop the engine immediately and check the engine oil level.

Starting Procedure

This motorcycle has a fuel-injected engine with an automatic fast idle. Follow the procedure indicated below.

Any Air Temperature

- Press the start button with the throttle completely closed.

The engine will not start if the throttle is fully open (because the electronic control module cuts off the fuel supply).

Starting & Stopping the Engine

Flooded Engine

If the engine fails to start after repeated attempts, it may be flooded with excess fuel. To clear a flooded engine:

1. Leave the engine stop switch set to RUN.
2. Open the throttle fully.
3. Press the start button for 5 seconds.
4. Follow the normal starting procedure.
5. If the engine starts, then open the throttle slightly if idling is unstable. If the engine does not start, wait 10 seconds, then follow steps 1 – 4 again.

If the engine still won't start, refer to *If Your Engine Quits or Won't Start*, page 183.

Bank Angle Sensor Ignition Cut-off System

Your motorcycle's banking (lean angle) sensor system is designed to automatically stop the engine and fuel pump if the motorcycle is overturned.

Before restarting the engine, you must turn the ignition switch to the OFF position and then back to ON. The engine will not restart until you perform this procedure.

Starting & Stopping the Engine

How to Stop the Engine

Normal Engine Stop

To stop the engine, shift into neutral and turn the ignition switch OFF.

The engine stop switch should normally remain in the RUN position even when the engine is OFF.

If your motorcycle is stopped with the engine stop switch OFF and the ignition switch ON, the headlight and taillight will remain on, resulting in battery discharge.

Emergency Engine Stop

To stop the engine in an emergency, use the engine stop switch. To operate, press the switch to the OFF position.

Shifting Gears

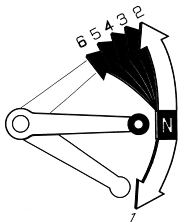

shifting pattern

Your motorcycle has six forward gears in a one-down, five-up shift pattern which is coordinated with a hydraulically actuated clutch system.

Learning when to shift gears comes with experience. Keep the following tips in mind:

- As a general rule, shift while moving in a straight line.

- Close the throttle and pull the clutch lever in completely before shifting. Improper shifting may damage the engine, transmission, and drive train.
- Learn to recognize the engagement point as you release the clutch lever. It is at this point the transmission of power to the rear wheel resumes.
- Upshift to a higher gear or reduce throttle before engine rpm (speed) gets too high. Learn the relationship between engine sound and the normal shifting points.
- Downshift to a lower gear before you feel the engine laboring (lugging) at low rpm.

(cont'd)

Shifting Gears

- Avoid downshifting to help slow your motorcycle when engine rpm is near its allowable maximum (near the tachometer red zone). In this situation, the rev limiter in the engine ignition control module may not prevent excessive engine speed which could damage the engine.
- To prevent transmission damage, do not coast or tow the motorcycle for long distances with the engine off.

Recommended Shift Points

Ride in the highest gear that lets the engine run and accelerate smoothly. This will give you good fuel economy and effective emissions control. When changing gears under normal conditions, use these recommended shift points:

Shifting Up:

From 1st to 2nd:	12 mph (20 km/h)
From 2nd to 3rd:	19 mph (30 km/h)
From 3rd to 4th:	25 mph (40 km/h)
From 4th to 5th:	31 mph (50 km/h)
From 5th to 6th:	37 mph (60 km/h)

Shifting Down:

From 6th to 5th:	28 mph (45 km/h)
From 5th to 4th:	22 mph (35 km/h)
From 4th to 3rd:	16 mph (25 km/h)

Pull the clutch lever in when speed drops below 9 mph (15 km/h), when engine roughness is evident, or when engine stalling is imminent; and shift down to 1st gear for acceleration.

Your motorcycle is equipped with a Linked Braking System. Operating the front brake lever applies the front brake and a portion of the rear brake. Operating the rear brake pedal applies the rear brake and a portion of the front brake. For full braking effectiveness, use both the lever and pedal simultaneously, as you would with a conventional motorcycle braking system.

Model Not Equipped with ABS:

As with a conventional motorcycle braking system, excessively hard application of the brake controls may cause wheel lock, reducing control of the motorcycle.

To slow or stop, apply the brake lever and brake pedal smoothly, while downshifting

to match your speed.

Gradually increase braking as you feel the brakes slowing your speed. The increase in engine compression from downshifting will help slow your motorcycle.

To prevent stalling the engine, pull the clutch lever in before coming to a complete stop. For support, put your left foot down first, then your right foot when you are through using the brake pedal.

Applying the brakes too hard may cause the wheels to lock and slide, reducing control of your motorcycle. If this happens, release the brake controls, steer straight ahead until you regain control, then reapply the brakes more gently.

Braking

When possible, reduce your speed or complete braking before entering a turn. Avoid braking or closing the throttle quickly while turning. Either action may cause one or both wheels to slip and reduce your control of your motorcycle.

Your ability to brake in a turn and to brake hard in an emergency situation are important riding skills. We suggest attending a Motorcycle Safety Foundation experienced rider training course (page 44) to retain these skills.

When riding in wet or rainy conditions, or on loose surfaces, the ability to maneuver and stop will be reduced. All of your actions should be smooth under these conditions. Rapid acceleration, braking or turning may cause loss of control. For

your safety, exercise extreme caution when braking, accelerating or turning.

When descending a long, steep grade, use engine compression braking by downshifting, with intermittent use of both brakes. Continuous brake application can overheat the brakes and reduce their effectiveness.

Riding with your foot resting on the brake pedal or your hand on the brake lever may actuate the brakelight, giving a false indication to other drivers. It may also overheat the brakes, reducing effectiveness.

Anti-Lock Brake System (ABS)

(INTERCEPTOR ABS)

This model is also equipped with an Anti-lock Brake System (ABS) designed to help prevent wheel lock up during hard braking on uneven or other poor surfaces while running straight. Although the wheel may not lock up — if you are braking too hard in a turn the motorcycle can still lose traction, causing a loss of control.

In some situations, a motorcycle with ABS may require a longer stopping distance to stop on loose or uneven surfaces than an equivalent motorcycle without ABS.

ABS cannot make up for road conditions, bad judgment, or improper operation of

the brakes. It is still your responsibility to ride at reasonable speeds for weather, road surface, and traffic conditions, and to leave a margin of safety.

ABS is self-checking and always on.

ABS may be activated by riding over a sharp drop or rise in the road level.

It is important to follow the tire recommendations (page 152). The ABS computer works by comparing wheel speed. Non-recommended tires can affect wheel speed and may confuse the ABS computer.

ABS does not function at low speeds (approximately 6 mph (10 km/h) or below).

ABS does not function if the battery is discharged.

Braking

ABS Indicator

(INTERCEPTOR ABS)

Normally, this indicator comes on when the ignition is turned ON, and goes off after you ride the motorcycle at a speed above 6 mph (10 km/h). If there is an ABS problem, the indicator comes on and remains on. The ABS system does not operate when the ABS indicator is on.

If the ABS indicator comes on while riding, stop the motorcycle in a safe place and turn off the engine.

Turn the ignition ON again. The indicator should come on, and go off after you ride the motorcycle at speeds above 6 mph (10 km/h). If it does not go off, ABS is not

functioning, but the brakes still work the Linked Braking System and provide normal stopping ability. However, you should have the system checked by Honda dealer as soon as possible.

The ABS indicator may come on if you turn the rear wheel while the motorcycle is upright on the stand. This is normal. Turn the ignition OFF, then turn it ON. The indicator should come on, then go off after you run the motorcycle above 6 mph (10 km/h).

1. Look for a level parking area. If you can't park on a paved surface, make sure the ground surface is firm. If you must park on a hill, leave the transmission in gear.

Make sure flammable materials such as dry grass or leaves do not come in contact with the exhaust system when parking your motorcycle. Refer to *Catalytic Converter*, page 229 .

2. Use the side stand to support the motorcycle while parked.
 - To lower the side stand, use your foot to guide it down. Remember that lowering the side stand with the transmission in gear will stop the engine, even if the clutch lever is pulled in. That is a function of the side stand ignition cut-off system.
 - Check that the side stand is down all the way so that the side stand ignition cut-off system (page 53) is activated.

(cont'd)

Parking

- If you have to park on a soft surface, insert something solid under the center stand for support.
- To lower the center stand, stand on the left side of the motorcycle. Hold the left hand grip with your left hand and, with your right hand, grasp the holder above the passenger footpeg. Press down on the tip of the stand with your right foot and, simultaneously, pull up and back on the hand grip.

3. Use the steering lock, which locks the handlebar in place. Turn the handlebar all the way to the left or right. Push in on the ignition key (1) and turn it to LOCK. Remove the key.

FRONT CENTER

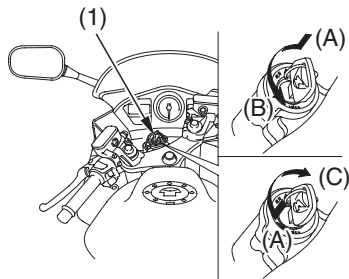

(1) ignition key

(A) push in

(B) turn to LOCK

(C) turn to UNLOCK

4. Use the helmet holder to secure your helmet with your motorcycle:

- Remove the seat (page 90).
- Hang your helmet on the holder hooks (1).
- Install the seat.

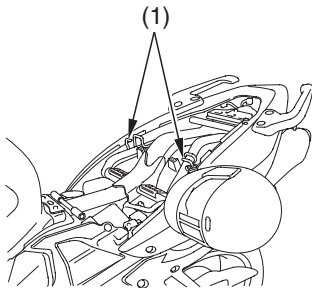

(1) holder hooks

⚠ WARNING

Riding with a helmet attached to the holder can interfere with the rear wheel or suspension and could cause a crash in which you can be seriously hurt or killed.

Use the helmet holder only while parked. Do not ride with a helmet secured by the holder.

Parking

Theft-Prevention Tips

- Park your motorcycle in a locked garage whenever possible. If a garage isn't available, park in a concealed area or in a well-lit area with enough pedestrian traffic to discourage a thief.
 - Always take the ignition key with you.
 - Always use the steering lock (page 64), even if you're parking for just a minute or two. A thief can easily push an unlocked motorcycle to a waiting truck.
 - In addition to the steering lock, use a good quality anti-theft device made specifically to lock a motorcycle to a secure object.
- If you decide to use an anti-theft device, select one of good quality and be sure to follow the manufacturer's instructions.
 - The rear fender has a storage compartment to store a U-shaped lock under the seat. After storing, use the rubber band (1) to securely fasten the lock. Some U-shaped locks may not be stored in the compartment due to their size or design.

UNDER SEAT

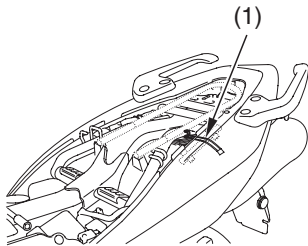

(1) rubber band

- Keep your owner's manual, current registration, and insurance information with your motorcycle. This will make it easier for the authorities to find you if your motorcycle is stolen and recovered.

Riding with a Passenger or Cargo

Your motorcycle is a high-performance sport model designed to carry you and one passenger. Whenever you add a passenger or cargo, you must be careful not to exceed the total load limits for this vehicle (*Load Limits*, page 49). Make sure your cargo is properly secured (*Loading Guidelines*, page 49).

Also consider adjusting the suspension (page 134) for the extra load.

Be aware that carrying a passenger or heavy cargo can affect acceleration, braking, and handling.

Before riding with a passenger, make sure your passenger is wearing the proper protective apparel (page 42). Also check that your passenger is not wearing any loose apparel that might get caught in the drive chain.

Tell your passenger to hold the grab rail or your waist, lean with you in the turns, and keep their feet on the passenger footpegs at all times, even when the motorcycle is stopped at a traffic light.

Servicing Your Honda

To help keep your motorcycle in good shape, this section includes a Maintenance Schedule for required service, a list of periodic checks you should perform at least once a month, and step-by-step instructions for specific maintenance tasks. You'll also find important safety precautions, information on fuels and oils, and tips for keeping your Honda looking great.

For information about the exhaust emission and noise emission requirements of the U.S. Environmental Protection Agency (EPA) and the California Air Resources Board (CARB), see page 223 .

For information about replacing fuses, see page 202 .

USA only

Maintenance, replacement or repair of the emission control devices and systems may be performed by any motorcycle repair establishment or individual using parts that are “certified” to EPA standards.

Before You Service Your Honda

The Importance of Maintenance.....	72
Maintenance Safety.....	73
Important Safety Precautions.....	74
Periodic Maintenance.....	76
Maintenance Schedule	78
Maintenance Record.....	83

(cont'd)

Servicing Your Honda

Service Preparations

Maintenance Component Locations	85
Tool Kit.....	88
Owner's Manual Storage.....	89
Seat Removal.....	90
Rear Seat Cover.....	91
Lower Fairing Removal	93
Inner Fairing Removal	95
Inner panel Removal	96
Clip Removal.....	97
Raising the Fuel Tank	98

Service Procedures

Fluids & Filters

Fuel	100
Engine Oil & Filter.....	104
Coolant.....	114
Air Cleaner	118

Engine

Throttle	120
Clutch System.....	122
Engine Idle Speed.....	125
Spark Plugs	127

Chassis

Suspension	134
Brakes	141
Tires	147
Side Stand	154
Drive Chain.....	155

Electrical

Battery.....	162
--------------	-----

Appearance Care	167
-----------------------	-----

Servicing Your Honda

The following table summarizes the three types of inspections and servicing recommendations for your motorcycle. Both the pre-ride inspection and the scheduled maintenance at the recommended intervals are necessary to assure safe and dependable performance. The periodic checks provide additional confidence in your motorcycle's performance.

Type of Inspection/Service	Refer to page:	When Performed	Who Performs
Pre-ride Inspection	45	before every ride	you
Periodic Maintenance	76	monthly*	you
Maintenance Schedule	78	interval on schedule	your Honda dealer**

* more often if you ride frequently or long distances; or anytime you clean your motorcycle

** unless you have the proper tools and service data and are mechanically qualified

The Importance of Maintenance

Keeping your motorcycle well-maintained is absolutely essential to your safety. It's also a good way to protect your investment, get maximum performance, avoid breakdowns, and have more fun. A properly maintained motorcycle will also help to reduce air pollution.

Remember, proper maintenance is the owner's responsibility. Be sure to inspect your motorcycle before each ride, perform the periodic checks, and follow the Maintenance Schedule in this section.

WARNING

Improperly maintaining this motorcycle or failing to correct a problem before you ride can cause a crash in which you can be seriously hurt or killed.

Always follow the inspection and maintenance recommendations and schedules in this owner's manual.

If your motorcycle overturns or is involved in a crash, be sure your Honda dealer inspects all major parts, even if you are able to make some repairs.

This section includes instructions on how to perform some important maintenance tasks. If you have basic mechanical skills, you can perform many of these tasks with the tools provided with your motorcycle.

Other tasks that are more difficult and require special tools are best performed by professionals. Wheel removal should normally be handled only by a Honda technician or other qualified mechanic. Instructions are included in this manual only to assist in emergency service.

Some of the most important safety precautions follow. However, we cannot warn you of every conceivable hazard that can arise in performing maintenance. Only you can decide whether or not you should perform a given task.

WARNING

Failure to properly follow maintenance instructions and precautions can cause you to be seriously hurt or killed.

Always follow the procedures and precautions in this owner's manual.

Maintenance Safety

Important Safety Precautions

- Make sure the engine is off before you begin any maintenance or repairs. This will help eliminate several potential hazards:

Carbon monoxide poisoning from engine exhaust. Be sure there is adequate ventilation whenever you operate the engine.

Burns from hot motorcycle parts. Let the engine and exhaust system cool before touching.

Injury from moving parts. Do not run the engine unless instructed to do so.

- Read the instructions before you begin, and make sure you have the tools and skills required.
- To help prevent the motorcycle from falling over, park it on a firm, level surface, using the center stand.
- To reduce the possibility of a fire or explosion, be careful when working around gasoline. Use only non-flammable solvent, not gasoline, to clean parts. Keep cigarettes, sparks, and flames away from all fuel-related parts.

Remember that your Honda dealer knows your motorcycle best and is fully equipped to maintain and repair it. To ensure the best quality and reliability, use only new genuine Honda parts or their equivalents for repair and replacement. If you have the tools and skills required for additional maintenance jobs, you can purchase an official Honda Service Manual (page 234).

Periodic Maintenance

In addition to the regularly scheduled maintenance (page 78) and daily pre-ride inspection (page 45), consider performing the periodic checks on the following page at least once a month, even if you haven't ridden your motorcycle, or as often as once a week if you ride frequently or for long distances. It's a good idea to perform this maintenance any time you clean your motorcycle.

Check the odometer reading and perform any scheduled maintenance checks that are needed (page 78). Remember, more frequent checks may be needed for riding in severe conditions.

Periodic Maintenance

Tires & Wheels	<p>Check the air pressure with a gauge and add air if needed (page 148). Examine the tread for wear (page 149). Look closely for nails, embedded objects, cuts, and other types of damage (page 149). Roll your motorcycle so you can inspect the entire surface.</p> <p>Check the condition of the wheels.</p>
Fluids	<p>Check the levels of the engine oil (page 108), coolant (page 115), clutch fluid (page 123) and brake fluid (page 143). Add the correct fluid as necessary, and investigate the cause of any low fluid level.</p>
Lights	<p>Make sure the headlight, brakelight, taillight, and turn signals are working properly.</p>
Freeplay	<p>Check the freeplay of the clutch lever (page 122), throttle grip (page 120), and the front brake lever (page 141) and rear brake pedal.</p>
Drive Chain	<p>Check condition, adjust slack, and lubricate as needed (page 155).</p>
Fuses	<p>Make sure you have a full supply of spare fuses.</p>
Nuts & Bolts	<p>Check the major fasteners and tighten as needed.</p>

Maintenance Schedule

The required Maintenance Schedule that follows specifies how often you should have your motorcycle serviced, and what things need attention. It is essential to have your motorcycle serviced as scheduled to maintain safe, dependable performance and proper emission control.

The service intervals in this Maintenance Schedule are based on average riding conditions. Some items will need more frequent service if you ride in unusually wet or dusty areas or at full throttle. Consult your Honda dealer for recommendations applicable to your individual needs and use.

Some items in the Maintenance Schedule can be performed with basic mechanical skills and hand tools. Procedures for these items are provided in this manual. Other items involve more extensive procedures and may require special training, tools, and equipment. We recommend that you have your Honda dealer perform these tasks unless you have advanced mechanical skills and the required tools and equipment. Procedures for such items in this schedule are provided in an official Honda Service Manual available for purchase (page 234).

Maintenance Schedule

If you do not feel capable of performing a given task or need assistance, remember that your Honda dealer knows your motorcycle best and is fully equipped to maintain and repair it. If you decide to do your own maintenance, use only genuine Honda parts or their equivalents for repair or replacement to ensure the best quality and reliability.

Perform the pre-ride inspection (page 45) and owner maintenance (page 80) at each scheduled maintenance period.

Each item on the maintenance schedule requires some mechanical knowledge. Certain items (particularly those marked * and **) may require more technical information and tools. Consult your Honda dealer.

- * Should be serviced by your dealer, unless the owner has proper tools and service data and is mechanically qualified. Refer to the official Honda Service Manual (page 234).
- ** In the interest of safety, we recommend these items be serviced only by your Honda dealer.

Maintenance Schedule

Summary of Maintenance Schedule Notes & Procedures:

NOTES:

1. At higher odometer reading, repeat at the frequency interval established here.
2. Service more frequently when riding in unusually wet or dusty areas.
3. USA only.
4. Replace every 2 years, or at indicated odometer interval, whichever comes first. Replacement requires mechanical skill.

Maintenance Procedures:

I: inspect and clean, adjust, lubricate,
or replace, if necessary

C: clean

A: adjust

L: lubricate

R: replace

Maintenance Schedule

ITEM		FREQUENCY	NOTE	ODOMETER READING (Note 1)								Refer to page	
				× 1,000 mi	0.6	4	8	12	16	20	24		
				× 1,000 km	1.0	6.4	12.8	19.2	25.6	32.0	38.4		
EMISSION RELATED ITEMS	*	FUEL LINE					I		I		I	—	
	*	THROTTLE OPERATION					I		I		I	—	
		AIR CLEANER	2					R			R	119	
		SPARK PLUGS			EVERY 16,000 mi (25,600 km) I, EVERY 32,000 mi (51,200 km) R							127	
	*	VALVE CLEARANCE								I		—	
		ENGINE OIL			INITIAL = 600 mi (1,000 km) or 1 month: R REGULAR = EVERY 8,000 mi (12,800 km) or 12 months: R							108	
		ENGINE OIL FILTER				R		R		R		R	109
	*	ENGINE IDLE SPEED				I	I	I	I	I	I	I	125
		RADIATOR COOLANT	4					I		I		R	115
	*	COOLING SYSTEM						I		I		I	—
	*	SECONDARY AIR SUPPLY SYSTEM						I		I		I	—
*	EVAPORATIVE EMISSION CONTROL SYSTEM	3						I			I	—	

* Should be serviced by your dealer, unless the owner has proper tools and service data and is mechanically qualified. Refer to the official Honda Service Manual (page 234).

** In the interest of safety, we recommend these items be serviced only by your Honda dealer.

Maintenance Schedule

ITEM		FREQUENCY	NOTE	ODOMETER READING (Note 1)								Refer to page	
				× 1,000 mi	0.6	4	8	12	16	20	24		
				× 1,000 km	1.0	6.4	12.8	19.2	25.6	32.0	38.4		
NON-EMISSION RELATED ITEMS		DRIVE CHAIN		EVERY 500 mi (800 km) I, L								160	
		BRAKE FLUID	4			I	I	R	I	I	R	143	
		BRAKE PADS WEAR				I	I	I	I	I	I	145	
		BRAKE SYSTEM			I		I		I		I	146	
	*	BRAKE LIGHT SWITCH					I		I		I	—	
	*	HEADLIGHT AIM					I		I		I	—	
		CLUTCH SYSTEM					I		I		I	122	
		CLUTCH FLUID	4				I	I	R	I	I	R	123
		SIDE STAND					I		I		I	154	
	*	SUSPENSION					I		I		I	—	
	*	NUTS, BOLTS, FASTENERS				I		I		I		I	—
	**	WHEELS/TIRES						I		I		I	—
	**	STEERING HEAD BEARINGS				I		I		I		I	—

* Should be serviced by your dealer, unless the owner has proper tools and service data and is mechanically qualified. Refer to the official Honda Service Manual (page 234).

** In the interest of safety, we recommend these items be serviced only by your Honda dealer.

Maintenance Record

Keeping an accurate maintenance record will help ensure that your motorcycle is properly maintained. Retain detailed receipts to verify the maintenance was performed. If the motorcycle is sold, these receipts should be transferred with the motorcycle to the new owner. Make sure whoever performs the maintenance completes this record. All scheduled maintenance, including the 600 mile (1,000 km) initial maintenance, is considered a normal owner operating cost and will be charged for by your dealer. Use the space under Notes to record anything you want to remind yourself about or mention to your dealer.

Miles (km)	Odometer	Date	Performed By:	Notes
600 (1,000)				
4,000 (6,400)				
8,000 (12,800)				
12,000 (19,200)				
16,000 (25,600)				
20,000 (32,000)				

Maintenance Record

Miles (km)	Odometer	Date	Performed By:	Notes
24,000 (38,400)				
28,000 (44,800)				
32,000 (51,200)				
36,000 (57,600)				
40,000 (64,000)				
44,000 (70,400)				
48,000 (76,800)				
52,000 (83,200)				
56,000 (89,600)				
60,000 (96,000)				
64,000 (102,400)				
68,000 (108,800)				

Maintenance Component Locations

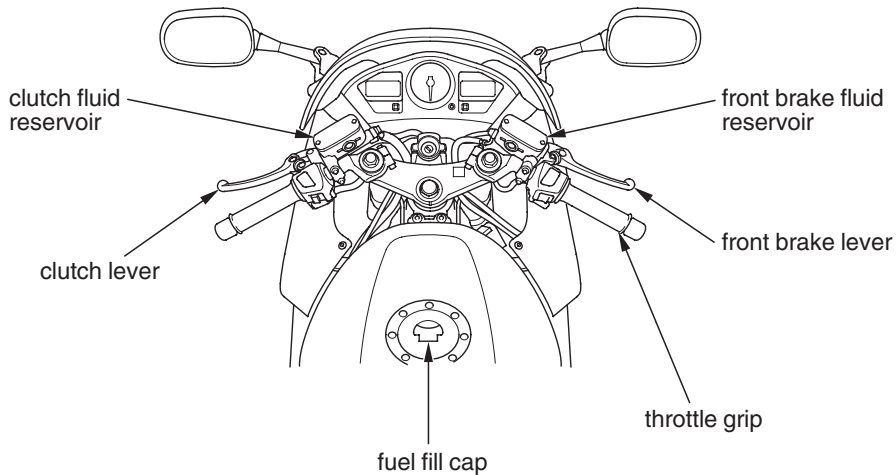

Maintenance Component Locations

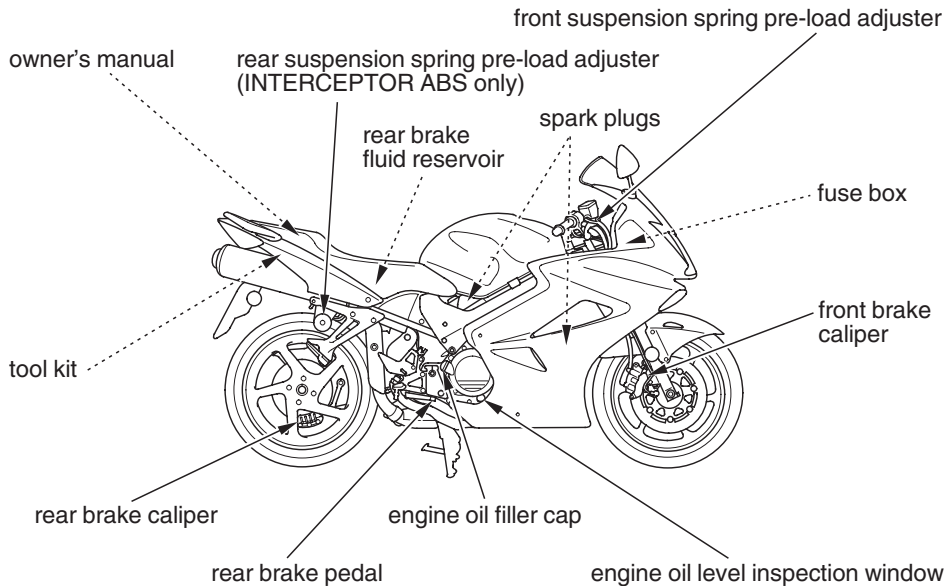

Maintenance Component Locations

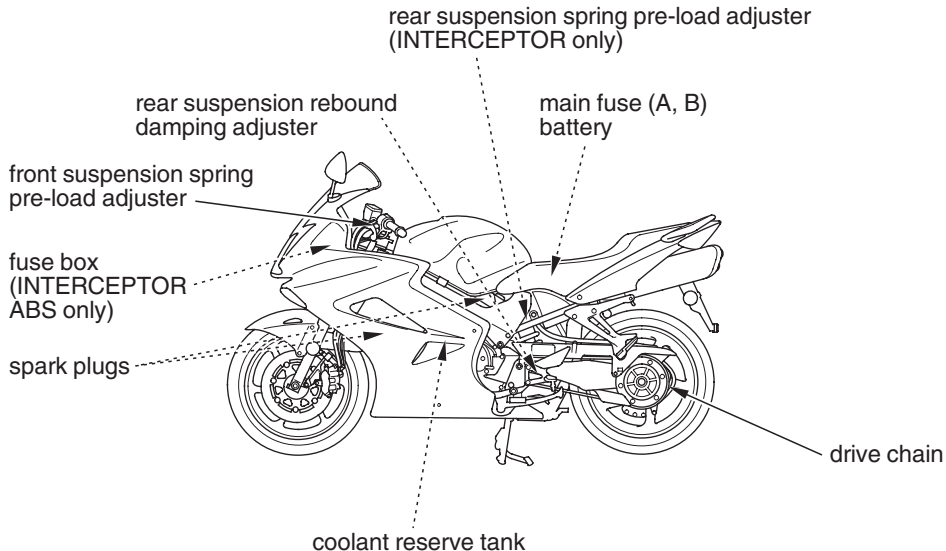

Tool Kit

The tool kit (1) is stored under the seat (page 90).

An optional, larger tool kit may be available. Check with your Honda dealer's parts department.

UNDER SEAT

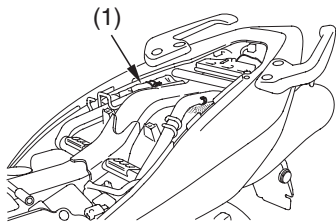

(1) tool kit

Owner's Manual Storage

Your motorcycle provides storage for the owner's manual so you'll have it with you for easy reference. Store your owner's manual (and other documents) in the plastic storage bag (1) in the storage compartment (2) under the seat.

Be careful not to flood this area when washing your motorcycle.

UNDER SEAT

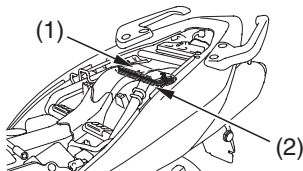

- (1) owner's manual storage bag
- (2) owner's manual storage compartment

Seat Removal

Refer to *Safety Precautions* on page 74 .

The seat must be removed for battery, main fuse and rear brake reservoir maintenance, to use the helmet holder, to access the tool kit and owner's manual, or to lift the fuel tank.

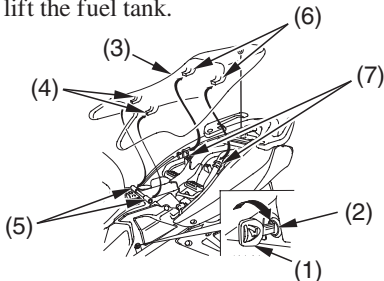

- | | |
|------------------|------------------|
| (1) ignition key | (4) front prongs |
| (2) seat lock | (5) front stays |
| (3) seat | (6) rear prongs |
| | (7) rear stays |

Removal

1. Insert the ignition key (1) into the seat lock (2).
2. Turn it clockwise and pull up on the rear of the seat (3).
3. Pull the seat back and up.

Installation

1. Insert the front prongs (4) into the front stays (5) and the rear prongs (6) into the rear stays (7) on the frame.
2. Push forward and then down on the rear of the seat.

Be sure to securely lock the seat after reinstalling it.

Rear Seat Cover

Refer to *Safety Precautions* on page 74 .

Installation

1. Remove the seat (page 90).
2. Remove the caps (1), grab rail mounting bolts (2) and washers (3).
3. Remove the grab rails (4).
4. Install the grab rail covers (5).

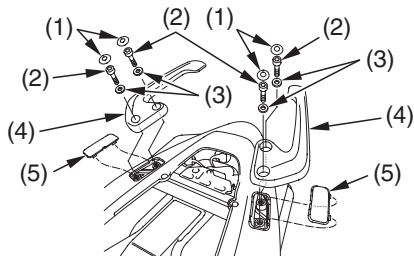

- | | |
|------------------------------|----------------|
| (1) caps | (3) washers |
| (2) grab rail mounting bolts | (4) grab rails |
| (5) grab rail covers | |

5. Turn the seat over.
6. Install the rear seat cover (6) to the seat.
7. Fit the stopper holes (7) of rear seat cover securely into the pins (8).
8. Install the seat (page 90).

The grab rails must be returned to position when riding in tandem.

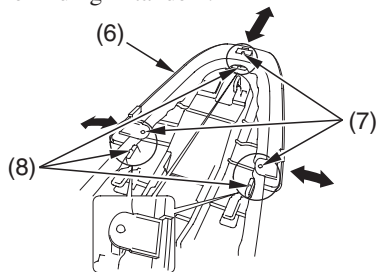

- | |
|---------------------|
| (6) rear seat cover |
| (7) stopper holes |
| (8) pins |

Rear Seat Cover

Removal

1. Removal can be done in the reverse order of installation.
The grab rails should be installed for riding with a passenger.
2. Tighten the grab rail mounting bolts (2) to the specified torque:
16 lbf·ft (22 N·m , 2.2 kgf·m)

If a torque wrench was not used for installation, see your Honda dealer as soon as possible to verify proper assembly. The grab rails could come off easily and result in serious injury if the assembly is not done properly.

3. Install the seat (page 90).

Lower Fairing Removal

Refer to *Safety Precautions* on page 74 .

The lower fairing must be removed to service the coolant reserve tank or to remove the inner fairing.

RIGHT SIDE

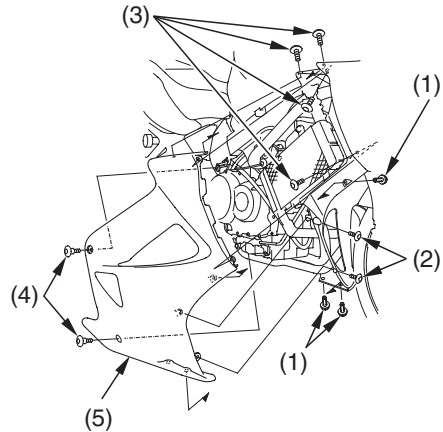

(1) clips
(2) A bolts
(3) B bolts

(4) C bolts
(5) lower fairing

Lower Fairing Removal

LEFT SIDE

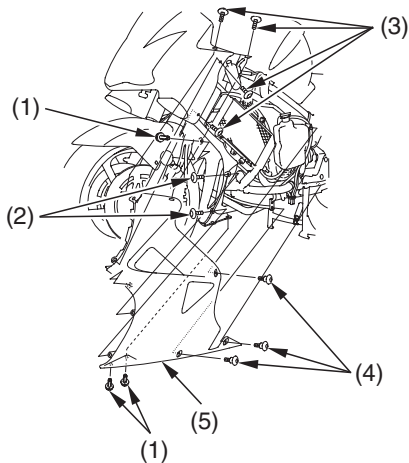

(1) clips

(2) A bolts

(3) B bolts

(4) C bolts

(5) lower fairing

Removal

1. Remove the clips (1).
2. Remove the A bolts (2).
3. Remove the B bolts (3).
4. Remove the C bolts (4).
5. Remove the lower fairing (5).

Installation

- Installation can be done in the reverse order of removal.

Inner Fairing Removal

Refer to *Safety Precautions* on page 74 .

The inner fairing must be removed to service the engine oil filter.

Removal

1. Remove the lower fairing (page 93).
2. Remove the clips (1).
3. Remove the inner fairing (2).

Installation

- Installation can be done in the reverse order of removal.

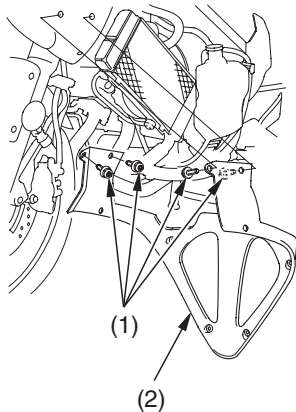

(1) clips

(2) inner fairing

Inner Panel Removal

Refer to *Safety Precautions* on page 74 .

The inner panel must be removed to service the fuses.

Removal

1. Remove the bolts (1).
2. Remove the clip (2).
3. Remove the inner panel (3).

Installation

- Installation can be done in the reverse order of removal.

LEFT FRONT (right side similar)

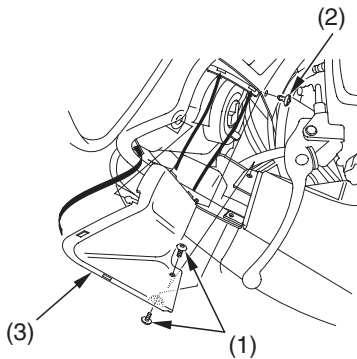

(1) bolts
(2) clip

(3) inner panel

Clip Removal

Clip removal and installation:

Removal

- ① Press down on the center pin to release the lock.
- ② Pull the clip out of the hole.

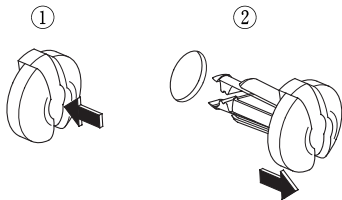

Installation

- ① Slightly open the retaining pawls and then push them out.
- ② Insert the clip into the hole.
- ③ Lightly press down on the center pin to lock the clip.

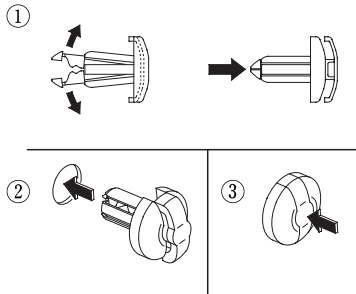

Raising the Fuel Tank

Refer to *Safety Precautions* on page 74 .

The fuel tank must be raised to service the air cleaner or the rear cylinder spark plugs. The fuel tank does not require draining for this procedure.

1. Place the motorcycle on its center stand with the transmission in neutral and the ignition switch off.
Check that the fuel fill cap is closed.
2. Remove the seat (page 90).
3. Remove the two bolts (1) with washers (2) and the collars (3).

RIGHT SIDE

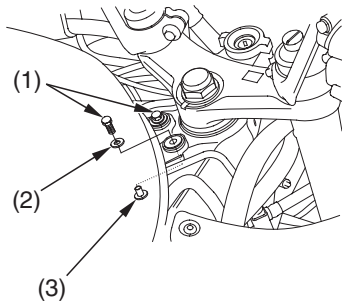

- (1) bolts
- (2) washers
- (3) collars

Raising the Fuel Tank

4. Insert the pin spanner (4) in the extension bar (5) provided in the tool kit (page 88).
5. Raise the front of the fuel tank (6) and install the bolt (1) to frame body.

Do not raise the fuel tank higher than the stopper cable (7) allows.

6. Place the base of the extension bar over the installed bolt and position the pin spanner so that it supports the fuel tank.

When raising the fuel tank, be careful not to allow the collars fall down.

RIGHT SIDE

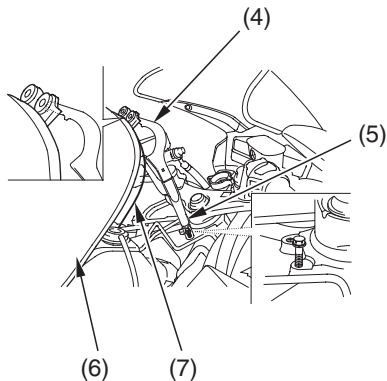

- (4) pin spanner
- (5) extension bar
- (6) fuel tank
- (7) stopper cable

Fuel

Refer to *Safety Precautions* on page 74 .

Fuel Recommendation

type	unleaded
pump octane number	86 (or higher)

We recommend that you use unleaded fuel because it produces fewer engine deposits and extends the life of exhaust system components.

The use of leaded gas will damage the catalytic converter.

Your engine is designed to use any gasoline that has a pump octane number of 86 or higher. Gasoline pumps at service stations normally display the pump octane number. For information on the use of oxygenated fuels, see page 230.

Use of lower octane gasoline can cause persistent “pinging” or “spark knock” (a loud rapping noise) which, if severe, can lead to engine damage. Light pinging experienced while operating under a heavy load, such as climbing a hill, is no cause for concern.

If pinging or spark knock occurs at a steady engine speed under normal load, change brands of gasoline. If pinging or spark knock persists, consult your Honda dealer.

Fuel

Never use stale or contaminated gasoline or an oil/gasoline mixture. Avoid getting dirt, dust, or water in the fuel tank.

Fuel Capacity

Fuel tank capacity:
5.81 US gal (22.0 ℓ)

Refueling Procedure

Refer to *Safety Precautions* on page 74 .

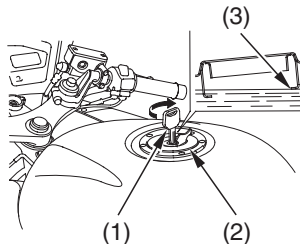

- (1) ignition key (3) filler neck
(2) fuel fill cap

1. Insert the ignition key (1) in the fuel fill cap (2) and turn it clockwise.

2. Open the cap.
3. Add fuel until the level reaches the bottom of the filler neck (3). Avoid overfilling the tank. There should be no fuel in the filler neck.

WARNING

Gasoline is highly flammable and explosive. You can be burned or seriously injured when handling fuel.

- Stop the engine and keep heat, sparks and flame away.
- Handle fuel only outdoors.
- Wipe up spills immediately.

4. After refueling, push the fuel fill cap closed until it snaps and locks.
5. Remove the ignition key from the cap.

Engine Oil & Filter

Engine oil quality is a major factor that affects both the performance and the service life of the engine.

Using the proper oil (page 105) and filter, and regularly checking, adding, and changing oil will help extend your engine's life. Even the best oil wears out. Changing oil helps get rid of dirt and deposits in the engine. Operating the engine with old or dirty oil can damage your engine. Running the engine with insufficient oil can cause serious damage to the engine and transmission.

Change the engine oil as specified in the maintenance schedule on page 81 .

When running in very dusty conditions, oil changes should be performed more frequently than specified in the maintenance schedule.

Oil Recommendation

API classification	SG or higher except oils labeled as energy conserving on the circular API service label
viscosity (weight)	SAE 10W-40
JASO T 903 standard	MA

suggested oil*

Pro Honda GN4 or HP4 (without molybdenum additives) 4-stroke oil (USA & Canada), or Honda 4-stroke oil (Canada only), or an equivalent motorcycle oil.

- * Suggested oils are equal in performance to SJ oils that are not labeled as energy conserving on the circular API service label.

(cont'd)

Engine Oil & Filter

- Your motorcycle does not need oil additives. Use the recommended oil.
- Do not use oils with graphite or molybdenum additives. They may adversely affect clutch operation.
- Do not use API SH or higher oils displaying a circular API “energy conserving” service label on the container. They may affect lubrication and clutch performance.



NOT RECOMMENDED OK

- Do not use non-detergent, vegetable, or castor based racing oils.

Other viscosities shown in the following chart may be used when the average temperature in your riding area is within the indicated range.

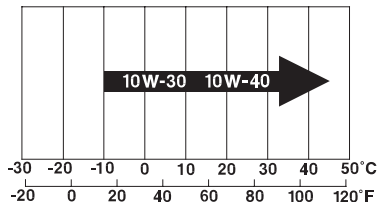

JASO T 903 standard

The JASO T 903 standard is an index for engine oils for 4-stroke motorcycle engines.

There are two classes: MA and MB. Oil conforming to the standard is labeled on the oil container. For example, the following label shows the MA classification.

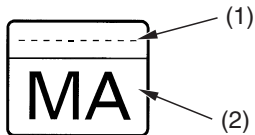

PRODUCT MEETING JASO T 903
COMPANY GUARANTEEING THIS MA PERFORMANCE:

- (1) code number of the sales company of the oil
- (2) oil classification

Engine Oil & Filter

Checking & Adding Oil

Refer to *Safety Precautions* on page 74.

RIGHT SIDE

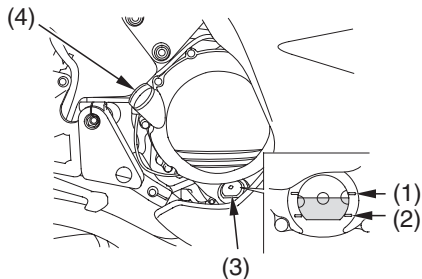

- (1) upper level mark
- (2) lower level mark
- (3) oil inspection window
- (4) oil filler cap

1. Park your motorcycle on its center stand on a firm, level surface.
2. Start the engine and let it idle for 3–5 minutes. Make sure the low oil pressure indicator goes off. If the indicator remains on, stop the engine immediately.
3. Stop the engine and wait 2–3 minutes.
4. Check that the oil level is between the upper (1) and lower (2) level marks in the oil inspection window (3).
 - If the oil is at or near the upper level mark — you do not have to add oil.
 - If the oil is below or near the lower level mark — remove the oil filler cap (4) and add the recommended oil until it reaches the upper level mark. (Do not overfill.)

5. Reinstall the oil filler cap.
6. Check for oil leaks.

Changing Engine Oil & Filter

Refer to *Safety Precautions* on page 74.

Your motorcycle's oil filter has very specific performance requirements. Use a new genuine Honda oil filter or a filter of equal quality specified for your model.

NOTICE

Using the wrong oil filter may result in leaks or premature engine damage.

Engine Oil & Filter

This procedure requires mechanical skill and professional tools such as a torque wrench and oil filter wrench, as well as a means for disposing of the drained fluid (page 180). If you do not have the skills or the tools, see your Honda dealer.

Drain the Engine Oil:

1. Park your motorcycle on its center stand on a firm, level surface.
2. If the engine is cold, start it and let it idle for 3–5 minutes. Turn the engine off. Wait 2–3 minutes for the oil to settle.
3. Remove the lower fairing (page 93) and inner fairing (page 95).

4. Place a drain pan under the crankcase drain bolt (1).
5. To drain the oil, remove the oil filler cap, crankcase drain bolt, and sealing washer (2).

LEFT SIDE

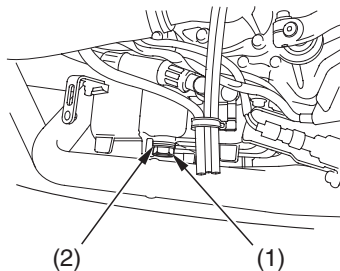

(1) crankcase
drain bolt

(2) sealing washer

Engine Oil & Filter

Install a New Oil Filter:

6. Remove the oil filter (3) with a filter wrench and let the remaining oil drain out. Discard the oil filter in an approved manner (page 180).
7. Pour the drained oil into a suitable container and dispose of it in an approved manner (page 180).

NOTICE

Improper disposal of drained fluids is harmful to the environment.

LEFT SIDE

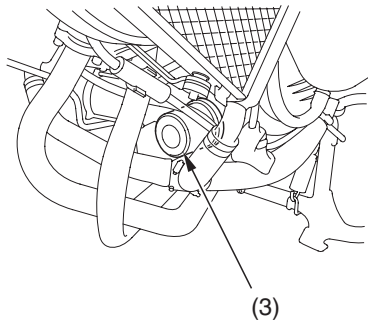

(3) oil filter

(cont'd)

Engine Oil & Filter

8. Apply a thin coat of engine oil to the rubber seal (4) of a new oil filter.

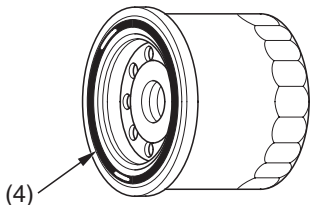

(4) oil filter rubber seal

9. Install the new oil filter and tighten it by hand.
10. Using an oil filter wrench attachment and a torque wrench, tighten the new oil filter to the specified torque:
20 lbf·ft (26 N·m , 2.7 kgf·m)

11. Check the condition of the sealing washer on the engine oil drain bolt. Replace the washer every other time the oil is changed.
- Install the engine oil drain bolt and tighten it to the specified torque:
22 lbf·ft (30 N·m , 3.1 kgf·m)

Add Engine Oil:

12. Fill the crankcase with the recommended oil (page 105), approximately:
3.3 US qt (3.1 ℓ)
13. Install the oil filler cap.

14. Start the engine and let it idle for a few minutes.
15. Stop the engine. Wait several minutes.
16. Check that the oil level is at the upper level mark in the oil inspection window (page 108).
17. Check that there are no oil leaks.
18. Install the lower fairings and inner fairing.

If a torque wrench is not used for installation, see your Honda dealer as soon as possible to verify proper assembly.

Coolant

Your motorcycle's liquid cooling system dissipates engine heat through the coolant jacket that surrounds the cylinder and cylinder head.

Maintaining the coolant will allow the cooling system to work properly and prevent freezing, overheating, and corrosion.

Coolant Recommendation

Use Pro Honda HP coolant or an equivalent high quality ethylene glycol antifreeze containing corrosion protection inhibitors specifically recommended for use in aluminum engines. Check the antifreeze container label.

Use only distilled water as a part of the

coolant solution. Water that is high in mineral content or salt may be harmful to the aluminum engine.

NOTICE

Using coolant with silicate inhibitors may cause premature wear of water pump seals or blockage of radiator passages. Using tap water may cause engine damage.

The factory provides a 50/50 solution of antifreeze and water in this motorcycle. This coolant solution is recommended for most operating temperatures and provides good corrosion protection.

Decreasing the concentration of antifreeze to less than 40% will not provide proper corrosion protection.

Increasing the concentration of antifreeze is not recommended because it decreases cooling system performance. Higher concentrations of antifreeze (up to 60%) should only be used to provide additional protection against freezing. Check the cooling system frequently during freezing weather.

Checking & Adding Coolant

Refer to *Safety Precautions* on page 74.

LEFT SIDE

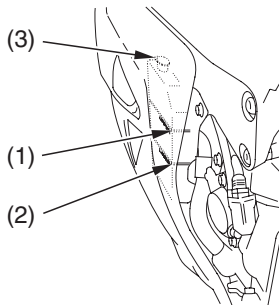

- (1) UPPER level mark
- (2) LOWER level mark
- (3) reserve tank cap

Coolant

1. With the engine at normal operating temperature, check the coolant level in the reserve tank. It should be between the UPPER (1) and LOWER (2) level marks.
If the reserve tank is empty, or if coolant loss is excessive, check for leaks and see your Honda dealer for repair.
2. Remove the lower fairing (page 93).
3. Remove the reserve tank cap (3).
Always add coolant to the reserve tank.
Do not attempt to add coolant by removing the radiator cap.
4. Add coolant to the reserve tank as required to bring the coolant level to the UPPER level mark.

Coolant Replacement

Refer to *Safety Precautions* on page 74 .

Coolant should be replaced by your Honda dealer, unless you have the proper tools and service data and are mechanically qualified. Refer to the official Honda Service Manual (page 234).

⚠ WARNING

Removing the radiator cap while the engine is hot can cause the coolant to spray out, seriously scalding you.

Always let the engine and radiator cool down before removing the radiator cap.

To properly dispose of drained coolant, refer to *You & the Environment*, page 180 .

NOTICE

Improper disposal of drained fluids is harmful to the environment.

Air Cleaner

Refer to *Safety Precautions* on page 74 .

Service the air cleaner more frequently if you ride in unusually wet or dusty areas. Your Honda dealer can help you determine the correct service interval for your riding conditions.

Your motorcycle's air cleaner has very specific performance requirements. Use a new genuine Honda air cleaner specified for your model or an air cleaner of equivalent quality.

NOTICE

Using the wrong air cleaner may result in premature engine damage.

Proper air cleaner maintenance can prevent premature engine wear or damage, expensive repairs, low engine power, poor gas mileage, and spark plug fouling.

NOTICE

Improper or lack of proper air cleaner maintenance can cause poor performance and premature engine wear.

Air Cleaner Replacement

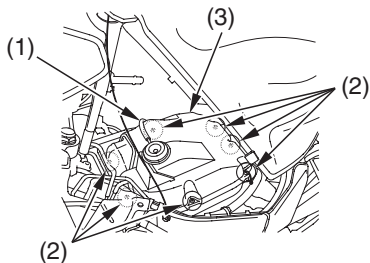

- (1) vacuum tube (3) air cleaner housing cover
(2) screws

1. Raise the fuel tank (page 98).
2. Disconnect the vacuum tube (1).
3. Remove the screws (2) that secure the air cleaner housing cover (3).
4. Remove the cover.

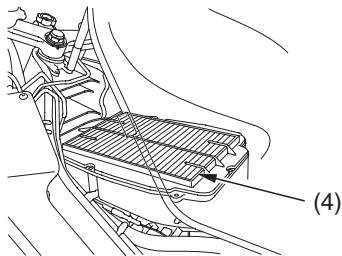

- (4) air cleaner

5. Remove the air cleaner (4).
6. Discard the air cleaner.
7. Install a new air cleaner.
8. Install the removed parts in reverse order of removal.

Throttle

Throttle Freeplay

Refer to *Safety Precautions* on page 74 .

RIGHT HANDLEBAR

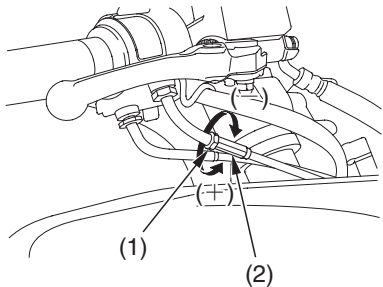

- (1) lock nut
(2) adjuster
- (+) increase
(-) decrease

Inspection

Check freeplay at the throttle grip flange.

Freeplay:

$1/16 - 1/4$ in (2–6 mm)

If necessary, adjust to the specified range.

Adjustment

1. Loosen the lock nut (1).
2. Turn the adjuster (2).
3. After adjustment, check for smooth rotation of the throttle grip from fully closed to fully open in all steering positions.

Throttle Inspection

Refer to *Safety Precautions* on page 74 .

1. Check that the throttle assembly is positioned properly and the securing bolts are tight.
2. Check for smooth rotation of the throttle from fully open to fully closed in all steering positions. If there is a problem, see your Honda dealer.

Clutch System

Your motorcycle has a hydraulically-actuated clutch. There are no adjustments to perform, but the clutch system must be inspected periodically for fluid level and leakage.

If control lever freeplay becomes excessive and the motorcycle creeps or stalls when shifted into gear, or if the clutch slips, causing acceleration to lag behind engine speed, there is probably air in the clutch system. See your Honda dealer to have the air bled out of the system.

Clutch Lever Adjustment

Refer to *Safety Precautions* on page 74 .

The distance between the tip of the clutch lever and the grip may be adjusted.

LEFT HANDLEBAR

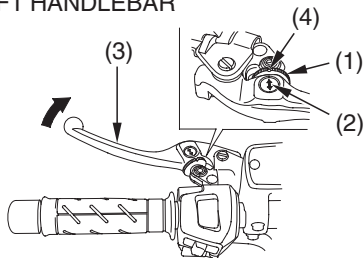

(1) adjuster

(2) arrow

(3) clutch lever

(4) index mark

1. Turn the adjuster (1) while pushing the clutch lever forward.
2. Align the arrow (2) on the clutch lever (3) with the index mark (4) on the adjuster.
3. Start the engine, pull the clutch lever in, and shift into gear. Make sure the engine does not stall and the motorcycle does not creep. Gradually release the clutch lever and open the throttle. Your motorcycle should move smoothly and accelerate gradually.

Fluid Level Inspection

Refer to *Safety Precautions* on page 74 .

LEFT FRONT

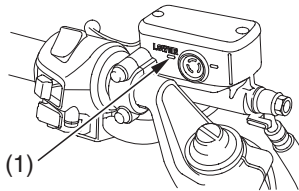

(1) LOWER level mark

Check that the fluid level is above the LOWER level mark. If the fluid level is below the LOWER level mark, it indicates fluid leakage. See your Honda dealer for repair.

Clutch System

Other Inspections

- Make sure there are no fluid leaks.
- Check for deterioration or cracks in the hose and fittings.
- Check that the clutch lever assembly is positioned properly and the securing bolts are tight.

Engine Idle Speed

2. Place your motorcycle on its center stand on a firm, level surface.
3. Shift into neutral. Start the engine.
4. Adjust idle speed with the throttle stop screw (1).

Idle speed (in neutral):

1,200 ± 100 rpm

Spark Plug Recommendation

standard spark plug	IMR9B – 9H (NGK) or VNH27Z (DENSO)
for cold climate (below 5°C, 41°F)	IMR8B – 9H (NGK) or VNH24Z (DENSO)

Use only the recommended type of spark plugs in the recommended heat range.

NOTICE

Using spark plugs with an improper heat range can cause engine damage.

This motorcycle uses spark plugs that have an iridium coated center electrode. Be sure to observe the following when servicing the spark plugs.

- Do not clean the spark plugs. If an electrode is contaminated with accumulated objects or dirt, replace the spark plug with a new one.
- Use only a “wire-type feeler gauge” to check the spark plug gap if necessary. To prevent damaging the iridium coating of the center electrode, never use a “leaf-type feeler gauge.”
- Do not adjust the spark plug gap. If the gap is out of specification, replace the spark plug with a new one.

Spark Plugs

Spark Plug Replacement & Inspection

Refer to *Safety Precautions* on page 74 .

Spark Plug Access

To access the rear cylinder spark plugs:

1. Raise the fuel tank (page 98).
2. Remove the bolts (1).
3. Disconnect the ignition coil connectors (2).
4. Disconnect the ignition coils (3) from the spark plugs.

LEFT SIDE (right side similar)
(rear cylinder)

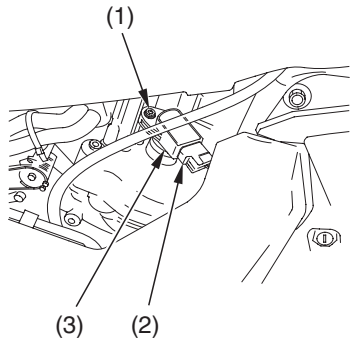

- (1) bolts
- (2) ignition coil connectors
- (3) ignition coils

Spark Plugs

5. Clean any dirt from around the spark plug bases.
6. Using a spark plug wrench (4), remove the spark plugs.

Be careful not to damage the hoses and the wire harness.

LEFT SIDE (right side similar)
(rear cylinder)

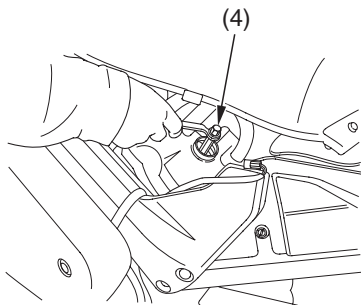

(4) spark plug wrench

Spark Plugs

To access the front cylinder spark plugs:

7. Remove the bolts (5) and wire harness holder (6).
8. Disconnect the ignition coil connectors (7).
9. Disconnect the ignition coils (8) from the spark plugs.

FRONT
(front cylinder)

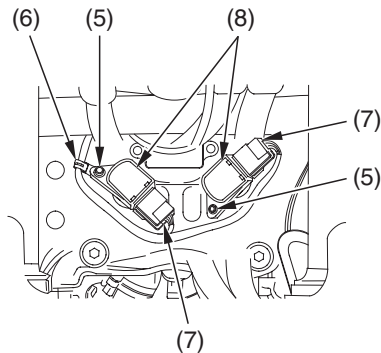

- (5) bolts
- (6) wire harness holder
- (7) ignition coil connectors
- (8) ignition coils

Spark Plugs

10. Clean any dirt from around the spark plug bases.
11. Using a spark plug wrench (4), remove the spark plugs.

FRONT
(front cylinder)

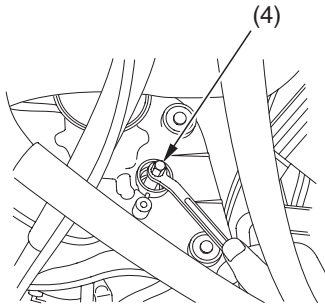

(4) spark plug wrench

12. Inspect the electrodes and center porcelain for deposits, corrosion, or carbon fouling. If the corrosion or deposits are heavy, replace the plug.
13. Make sure that a 1.0 mm wire-type feeler gauge cannot be inserted between the spark plug gap (9). If the gauge fits in the gap, replace the plug with a new one.
14. Make sure the plug washer is in good condition.

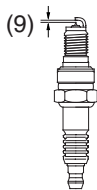

(9) spark plug gap

(cont'd)

Spark Plugs

15. With the plug washers attached, thread the spark plugs in by hand to prevent cross-threading.
16. Tighten each spark plug:
 - If the old plug is good:
1/8 turn after it seats.
 - If installing a new plug, tighten it twice to prevent loosening:
 - a) First, tighten the plug:
NGK: 1/2 turn after it seats.
DENSO: 1 turn after it seats.
 - b) Then loosen the plug.
 - c) Next, tighten the plug again:
1/8 turn after it seats.

NOTICE

Improperly tightened spark plugs can damage the engine. If a plug is too loose, a piston may be damaged. If a plug is too tight, the threads may be damaged.

17. Reinstall the ignition coils (10).
18. Connect the ignition coil connectors (11) to the ignition coils as before removal.
19. Install the wire harness holder (12) to the right side of front cylinder and install and tighten the bolts.
20. Install the remaining parts in the reverse order of removal.
21. Hold the ignition coils wire harness (13) in the right side of front cylinder with the wire harness holder (12).

RIGHT FRONT
(front cylinder)

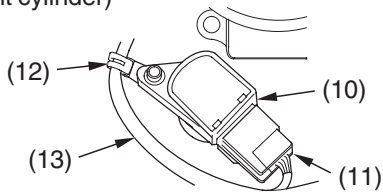

- (10) ignition coils
- (11) ignition coil connectors
- (12) wire harness holder
- (13) wire harness

Suspension

Your front and rear suspension systems use springs, hydraulic damping devices, and linkages (rear only) that suspend your weight and most of the weight of your motorcycle.

The spring pre-loads for your front and rear suspension systems adjust the amount of force required to begin compression of the spring.

The oil damper systems hydraulically control the rebound of the suspension springs so that traction and comfort are maintained as the wheels ride over road surfaces.

Consider adjusting your suspension whenever you change your normal load, by adding or subtracting a passenger, cargo, or accessories, or when the road or riding conditions change.

The way you ride your motorcycle and the type of ride you want to experience can also influence your suspension needs.

You may adjust the spring pre-load of both suspension systems. You may also adjust the rebound damping of the rear suspension system.

Lower spring pre-load and softer damping provide a softer ride and are usually preferred for light loads and smooth roads. Higher spring pre-load and firmer damping provide a firmer ride and are recommended for heavy loads, rough road conditions, and faster, more challenging riding.

Front Suspension Adjustment

The front suspension can be adjusted for rider (and passenger) weight and riding conditions by changing the spring pre-load.

Suspension

Front Suspension Spring Pre-load

Refer to *Safety Precautions* on page 74 .

FRONT

STANDARD POSITION

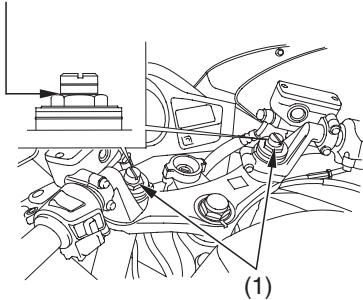

(1) pre-load adjuster

Adjust the spring pre-load by turning the pre-load adjuster (1).

Make sure that both fork legs are adjusted to the same position.

To Reduce Spring Pre-load (SOFT):

For a light load and smooth road conditions, turn the adjuster counterclockwise toward SOFT.

To Increase Spring Pre-load (HARD):

For a firmer ride and rough road conditions, turn the adjuster clockwise toward HARD.

Rear Suspension Adjustment

The rear suspension can be adjusted for rider (and passenger) weight and riding conditions by changing the spring pre-load and rebound damping.

The rear shock absorber includes a damper unit that contains high pressure nitrogen gas. Do not attempt to disassemble, service, or dispose of the damper; see your Honda dealer. The instructions found in this owner's manual are limited to adjustments of the shock assembly only.

Suspension

Rear Suspension Spring Pre-load

Refer to *Safety Precautions* on page 74 .

LEFT SIDE
(INTERCEPTOR)

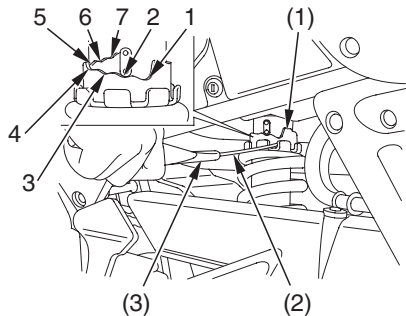

(1) spring pre-load adjuster
(2) pin spanner (3) extension bar

The spring pre-load adjuster (1) has 7 positions for different load or riding conditions.

Use the pin spanner (2) and extension bar (3) to adjust the rear shock spring pre-load.

Position 1: for a light load and smooth road conditions.

Position 2: standard position.

Positions 3 to 7: for when the motorcycle is more heavily loaded. (Also increase spring pre-load for stiffer rear suspension.)

Always adjust the shock absorber position in sequence (1-2-3-4-5-6-7 or 7-6-5-4-3-2-1). Attempting to adjust directly from 1 to 7 or 7 to 1 may damage the shock absorber.

(INTERCEPTOR ABS)

The spring pre-load adjuster knob (1) has 35 spring pre-load positions (clicks) or more for different load or riding conditions.

To adjust the spring pre-load, turn the adjuster knob (1).

To adjust to the standard position:

1. Turn the spring pre-load adjuster knob (1) counterclockwise until it will no longer turn (lightly seats). This is the full LOW setting.
2. Turn the adjuster clockwise by 7 clicks. At that position, the end of the adjuster knob (2) should be aligned with the indicator line (3).

To Reduce Spring Pre-load (LOW):

For a light load and smooth road conditions, turn the adjuster counterclockwise toward LOW.

To Increase Spring Pre-load (HIGH):

For a firmer ride and rough road conditions, turn the adjuster clockwise toward HIGH.

RIGHT SIDE

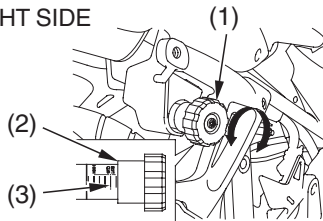

- (1) adjuster knob
(2) end of the adjuster knob
(3) indicator line

Suspension

Rear Suspension Damping

Refer to *Safety Precautions* on page 74 .

Rebound Damping

LEFT UNDER

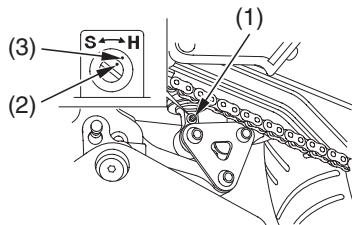

- (1) damping adjuster
- (2) punch mark
- (3) reference punch mark

To adjust to the standard position:

1. Turn the damping adjuster (1) clockwise until it will no longer turn. This is the full hard setting.
2. Turn the adjuster counterclockwise approximately 1 ¼ turns so that the punch mark (2) on the adjuster aligns with the reference punch mark (3). This is the standard position.

To Reduce Rebound Damping (SOFT):

For a light load and smooth road conditions, turn the adjuster counterclockwise toward SOFT (S).

To Increase Rebound Damping (HARD):

For a firmer ride and rough road conditions, turn the adjuster clockwise toward HARD (H).

The hydraulic braking systems on your motorcycle dissipate the heat generated by the friction of the brake pads on the brake discs as the wheels are slowed.

As the brake pads wear, the brake fluid level will drop. A leak in the system will also cause the level to drop.

Frequently inspect the system to ensure there are no fluid leaks. Periodically inspect the brake fluid level and the brake pads for wear.

If the brake lever or brake pedal freeplay does not feel within the normal range while riding, check the brake pads for wear (page 145). Worn pads should be replaced. If the pads are not worn beyond the recommended limit, there is probably

air in the brake system. See your Honda dealer to have the air bled from the system.

Front Brake Lever Adjustment

Refer to *Safety Precautions* on page 74 .

The distance between the tip of the brake lever and the grip may be adjusted.

RIGHT HANDLEBAR

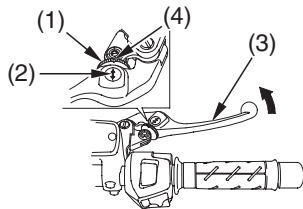

(1) adjuster

(2) arrow

(3) brake lever

(4) index mark

Brakes

1. Turn the adjuster (1) while pushing the lever forward.
2. Align the arrow (2) on the brake lever (3) with the index mark (4) on the adjuster.
3. Apply the brake, release it, then spin the wheel and check that it rotates freely. Repeat this procedure several times.

Brake Fluid Recommendation

brake fluid	Honda DOT 4 Brake Fluid
-------------	-------------------------

The recommended brake fluid is Honda DOT 4 Brake Fluid, or any brake fluid of equal quality and performance. Use fresh brake fluid from a sealed container. Be sure to read the label before opening the sealed container. An opened container may be contaminated or may have absorbed moisture from the air.

Fluid Level Inspection

Refer to *Safety Precautions* on page 74 .

If your inspection indicates a low fluid level, have your Honda dealer add the recommended brake fluid.

Do not add or replace brake fluid, except in an emergency. If you do add fluid, have your Honda dealer check the system as soon as possible.

NOTICE

Brake fluid can damage plastic and painted surfaces. Handle with care.

Wipe up spills immediately. Avoid contact with skin or eyes. In case of contact, wash thoroughly and call a doctor immediately if it contacts your eyes.

RIGHT HANDLEBAR (front brake)

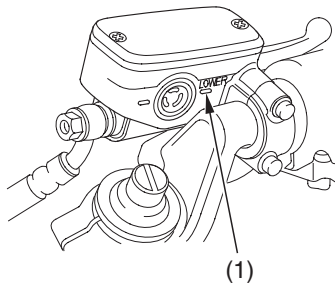

(1) LOWER level mark

Brakes

UNDER SEAT (rear brake)

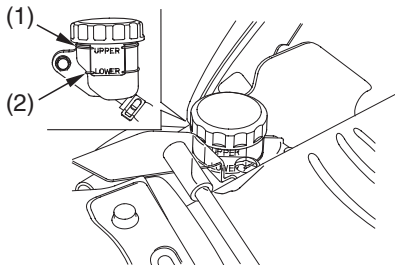

- (1) UPPER level mark
- (2) LOWER level mark

1. Place your motorcycle on its center stand on a firm, level surface.
2. Remove the seat (page 90).

3. Check the fluid level. It should be between the UPPER (1) and LOWER (2) level marks. If the level is at or below the LOWER level mark, check the brake pads for wear (page 145).

Worn pads should be replaced. If the pads are not worn beyond the recommended limit, have your brake system inspected for leaks.

Other Inspections

- Make sure there are no fluid leaks.
- Check for deterioration or cracks in the hoses and fittings.

Brake Pad Wear

Refer to *Safety Precautions* on page 74 .

Brake pad wear depends upon the severity of usage, the type of riding, and road conditions. Generally, the pads will wear faster on wet and dirty roads. Inspect the pads at each regular maintenance interval (page 82).

Always inspect both pads in both the right and left front brake calipers.

Check the cutouts (1) in each pad. If either pad is worn to the cutout, replace both pads as a set. See your Honda dealer for this service.

LEFT FRONT (right side similar)

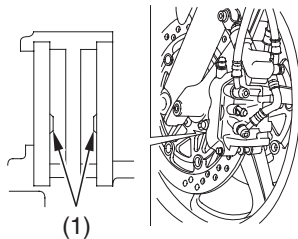

REAR

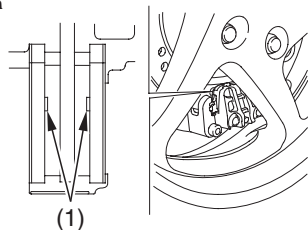

(1) cutouts

Brakes

Brake System Inspection

Refer to *Safety Precautions* on page 74 .

1. Place the motorcycle on its center stand, stop the engine, and place the transmission in neutral.
2. Move the left caliper assembly (1) upward while slowly rotating the rear wheel. The brake system is normal if the rear wheel stops. If the rear wheel does not stop, see your Honda dealer.

LEFT FRONT

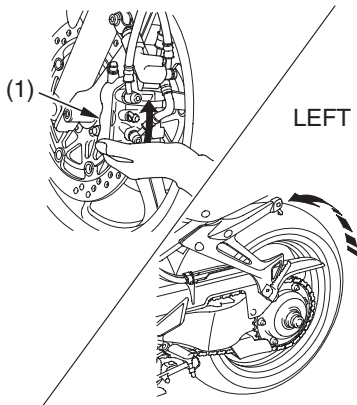

(1) left caliper assembly

To safely operate your motorcycle, your tires must be the proper type and size, in good condition with adequate tread, and correctly inflated for the load you are carrying.

WARNING

Using tires that are excessively worn or improperly inflated can cause a crash in which you can be seriously hurt or killed.

Follow all instructions in this owner's manual regarding tire inflation and maintenance.

The following pages give detailed information on how and when to check

your air pressure, how to inspect your tires for wear and damage, and our recommendations for tire repair and replacement.

Air Pressure

Refer to *Safety Precautions* on page 74 .

Properly inflated tires provide the best combination of handling, tread life, and riding comfort. Generally, underinflated tires wear unevenly, adversely affect handling, and are more likely to fail from being overheated. Overinflated tires make your motorcycle ride harshly, are more prone to damage from road hazards, and wear unevenly.

Tires

We recommend that you visually check your tires before every ride and use an air pressure gauge to measure the air pressure at least once a month or any time you think the tires might be low. Even tires that are in good condition may lose one to two psi per month if not checked and adjusted regularly.

Tubeless tires have some degree of self-sealing ability if they are punctured. However, because leakage is often very slow, you should look closely for punctures whenever a tire is not fully inflated.

Always check air pressure when your tires are “cold” — after the motorcycle has been parked for at least three hours. If you check air pressure when your tires are

“warm” — even if your motorcycle has only been ridden for a few miles — the readings will be higher. If you let air out of warm tires to match the recommended cold pressures, the tires will be underinflated.

The recommended “cold” tire pressures are:

front	36 psi (250 kPa , 2.50 kgf/cm ²)
rear	42 psi (290 kPa , 2.90 kgf/cm ²)

Inspection

Refer to *Safety Precautions* on page 74 .

Whenever you check the tire pressures, you should also look for:

- Bumps or bulges in the side of the tire or the tread. Replace any tire that has a bump or bulge.
- Cuts, slits, or cracks in the tires. Replace the tire if you can see fabric or cord.
- Nails or other foreign objects embedded in the side of the tire or tread.
- Excessive tread wear.

Also, if you hit a pothole or hard object while riding, pull to the side of the road as soon as you safely can and carefully inspect the tires for damage.

Tread Wear

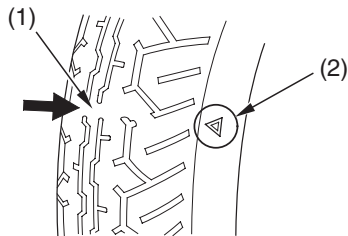

(1) wear indicator

(2) wear indicator location mark

Tires

For the best performance, you should replace a tire before the tread depth at the center reaches the following limits:

front	0.06 in (1.5 mm)
rear	0.08 in (2.0 mm)

If the wear indicators are visible, replace the tire immediately as it is no longer safe.

Tire Repair

Refer to *Safety Precautions* on page 74 .

We strongly recommend that you replace, not repair, any tire that is punctured or damaged. As discussed below, a tire that is repaired, either temporarily or permanently, will have lower speed and performance limits than a new or undamaged tire.

A temporary repair can sometimes be made in an emergency situation. However, since a temporary repair may not hold, you must ride very slowly, preferably without any cargo or passenger, and have the tire replaced or permanently repaired as soon as possible.

(For more information on temporary repairs, see *If You Have a Flat Tire*, page 188 .)

A permanent repair, such as an internal plug patch, can be made if a tire has only a small puncture in the tread area. With such a repair, you should not exceed 50 mph (80 km/h) for the first 24 hours, or 80 mph (130 km/h) at any time thereafter. In addition, you may not be able to safely carry as much weight. If you choose to have a tire repaired, be sure the repair work is performed by a professional and that the wheel is balanced before you ride.

If you have a tire professionally repaired at a non-Honda facility, we recommend that you have the work checked by your Honda dealer.

Tire Replacement

Refer to *Safety Precautions* on page 74 .

The tires that came on your motorcycle were designed to match the performance capabilities of your motorcycle and provide the best combination of handling, braking, durability, and comfort.

Tires

You should replace the tires with tires of the same size, load range, and speed rating as the originals.

⚠ WARNING

Installing improper tires on your motorcycle can affect handling and stability. This can cause a crash in which you can be seriously hurt or killed.

Always use the size and type of tires recommended in this owner's manual.

The recommended tires for your motorcycle are:

front	120/70ZR17M/C (58W) BRIDGESTONE BT020F BB DUNLOP D204FK METZELER MEZ4A FRONT
rear	180/55ZR17M/C (73W) BRIDGESTONE BT020R BB DUNLOP D204K METZELER MEZ4A
type	radial – ply, tubeless

Whenever you replace a tire, remember:

- Have the wheel balanced after the tire is installed.
- Have the tire replaced by your Honda dealer if possible.

If you have a tire professionally replaced at a non-Honda facility, we recommend that you have the work checked by your Honda dealer.

Important Safety Reminders

- Do not install a tube inside a tubeless tire on this motorcycle. Excessive heat build-up can cause the tube to burst.
- Use only tubeless tires on this motorcycle. The rims are designed for tubeless tires, and during hard acceleration or braking, a tube-type tire could slip on the rim and cause the tire to rapidly deflate.
- Do not install a bias-ply tire on this motorcycle. Mixing bias-ply and radial tires can adversely affect handling and stability.

Side Stand

Refer to *Safety Precautions* on page 74 .

LEFT SIDE

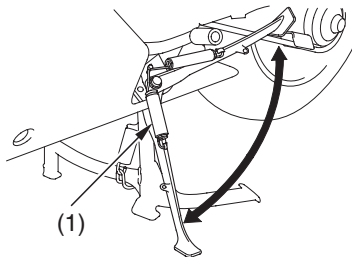

(1) side stand spring

- Check that the side stand assembly is working properly. If the side stand is stiff or squeaky, clean the pivot area and lubricate the pivot bolt with clean grease.

- Check the spring for damage or loss of tension.
- Check the side stand ignition cut-off system:
 1. Sit astride the motorcycle and put the transmission in neutral.
 2. Raise the side stand.
 3. Start the engine.
 4. Pull the clutch lever in.
 5. Shift the transmission into gear.
 6. Lower the side stand all the way.

The engine should stop as you lower the side stand. If the engine doesn't stop, see your Honda dealer for service.

An endless (riveted master link) chain connects the countershaft and rear wheel sprockets. The O-ring chain uses rubber rings between the side plates of the pin and roller links to seal in the manufacturer-installed lubricating grease and keep out moisture and dirt.

The service life of the chain depends on proper lubrication and adjustment. Poor maintenance can cause premature wear or damage to the drive chain or sprockets.

The drive chain should be checked, adjusted, and lubricated as part of the pre-ride inspection (page 45).

Under severe usage, or when the motorcycle is ridden in unusually dusty or muddy areas, more frequent maintenance will be necessary.

Before servicing your drive chain, turn the engine OFF, lower the center stand (page 64), and check that your transmission is in neutral.

It is not necessary to remove or replace the drive chain to perform the recommended service in the Maintenance Schedule.

Drive Chain

Inspection

Refer to *Safety Precautions* on page 74 .

1. Check slack in the lower drive chain
(1) run midway between the sprockets.
Drive chain slack should allow the following vertical movement by hand:
1 – 1 3/8 in (25 – 35 mm)

LEFT SIDE

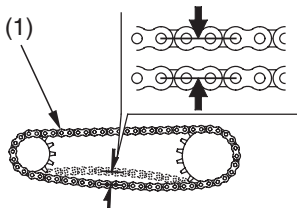

(1) drive chain

2. Check drive chain slack at several points along the chain. The slack should remain constant. If it isn't, some links may be kinked and binding. Lubricating the chain will often eliminate binding and kinking.
3. Inspect the drive chain for:
 - damaged rollers
 - dry or rusted links
 - kinked or binding links
 - excessive wear
 - improper adjustment
 - damaged or missing O-rings

Replace the drive chain (page 161) if it has damaged rollers, loose pins, or kinks that cannot be freed. Lubricate the drive chain (page 160) if it appears dry or shows signs of rust. Lubricate any kinked or binding links and work them free. Adjust chain slack if needed.

4. Inspect the front and rear sprocket teeth for excessive wear or damage. If necessary, have your Honda dealer replace a worn sprocket.

damaged
sprocket
teeth

REPLACE

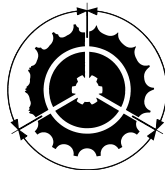

worn
sprocket
teeth

REPLACE

normal sprocket teeth
GOOD

NOTICE

Use of a new chain with worn sprockets will cause rapid chain wear.

Drive Chain

Wear Inspection

LEFT SIDE

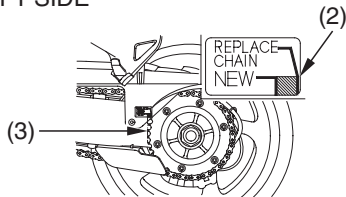

(2) red zone

(3) tip of driven sprocket teeth

Check the chain wear label when adjusting the chain. If the red zone (2) on the label aligns with the tip of driven sprocket teeth (3) after the chain has been adjusted to the proper slack, the chain is excessively worn and must be replaced. The proper slack is:

1 – 1 3/8 in (25 – 35 mm)

The bottom part of the frame may be damaged by excessive drive chain slack of more than:

1 15/16 in (50 mm)

Adjustment

Refer to *Safety Precautions* on page 74 .

Drive chain slack should be checked and adjusted, if necessary, every 500 miles (800 km). When operated at sustained high speeds or under conditions of frequent rapid acceleration, the chain may require more frequent adjustments.

Drive Chain

LEFT SIDE

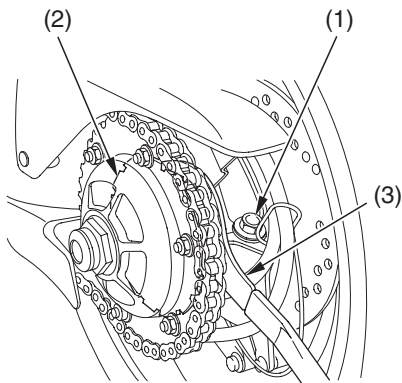

- (1) bearing holder pinch bolt
- (2) bearing holder
- (3) pin spanner

1. Place the motorcycle on its center stand with the transmission in neutral and the ignition switch OFF.
2. Loosen the bearing holder pinch bolt (1).
3. Turn the bearing holder (2) clockwise or counterclockwise to obtain the proper chain slack with the pin spanner (3).
4. Torque the bearing holder pinch bolt to: **54 lbf·ft (74 N·m , 7.5 kgf·m)**

If a torque wrench is not used for this installation, see your Honda dealer as soon as possible to verify proper assembly. Improper assembly may lead to a loss of braking capacity.

5. Recheck chain slack.
Chain slack should be:
1 – 1 3/8 in (25 – 35 mm)

Drive Chain

Lubrication

Refer to *Safety Precautions* on page 74 .

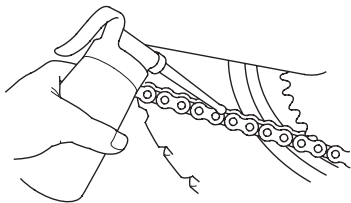

Lubricate every 500 miles (800 km) or sooner if chain appears dry. Lubricant: SAE 80 or 90 gear oil

Lubricate only with SAE 80 or 90 gear oil. Commercial chain lubricants may contain solvents which could damage the rubber O-rings.

Removal, Cleaning & Replacement

Refer to *Safety Precautions* on page 74 .

Your motorcycle has an endless (riveted master link) type chain. It should only be removed or replaced by your Honda dealer.

The O-rings can be damaged by steam cleaning, high pressure washers, and certain solvents.

1. Clean the side surfaces of the chain with a dry cloth. Use a high flashpoint solvent such as kerosene — not gasoline.
Do not brush the rubber O-rings. Brushing will damage them. Use of a solvent may also damage the O-rings.
2. Inspect the drive chain for possible wear or damage.

Replace the drive chain if it has damaged rollers, loose fitting links, damaged O-rings, or otherwise appears unserviceable.

Replacement Chain:

DID50VA8 or RK50HFOZ5

Battery

Your motorcycle has a maintenance-free type battery. You do not have to check the battery electrolyte level or add distilled water as you would with a conventional-type battery.

NOTICE

Your battery is a maintenance-free type and can be permanently damaged if the cap strip is removed.

Electrical accessories use current from the battery — even when the ignition is OFF. Limited operation also allows the battery to discharge. If you have electrical accessories on your motorcycle — or do not ride frequently, we recommend that you charge the battery frequently (see *Battery Charging*, page 165).

If you do not expect to ride your motorcycle for at least two weeks, we recommend you remove the battery — or at least disconnect the battery cables (negative cable first).

If you plan to store your motorcycle, see *Battery Storage*, page 163 .

If your battery seems weak and/or is leaking electrolyte (causing slow starting or other electrical problems), see your Honda dealer.

WARNING: Battery posts, terminals and related accessories contain lead and lead compounds. **Wash hands after handling.**

Battery Storage

Refer to *Safety Precautions* on page 74 .

If you plan to store your motorcycle, we recommend you remove the battery and store it where it can be charged at least every 30 days to maintain its service life.

If you do not remove the battery, we recommend disconnecting the battery cables (negative cable first).

You will get the best storage results from removing the battery and slow (trickle) charging it every 30 days (see *Battery Charging*, page 165).

Before you remove the battery, be sure to read all the information that follows, as well as the information on the battery label.

WARNING

The battery gives off explosive hydrogen gas during normal operation.

A spark or flame can cause the battery to explode with enough force to kill or seriously hurt you.

Wear protective clothing and a face shield, or have a skilled mechanic do the battery maintenance.

Battery

The battery is located in the battery box below the seat.

1. Remove the seat (page 90).
2. Remove the battery cover clips (1), then remove the battery cover (2).
3. Release the rings and remove the rubber band (3).
4. Disconnect the negative (-) terminal lead (4) from the battery first, then disconnect the positive (+) terminal lead (5).
5. Pull the battery (6) out of the battery box.

UNDER SEAT

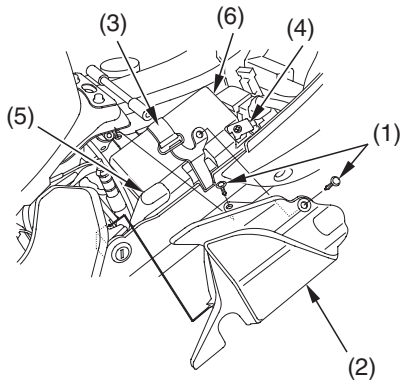

- (1) battery cover clips
- (2) battery cover
- (3) rubber band
- (4) negative (-) terminal lead
- (5) positive (+) terminal lead
- (6) battery

6. Charge the battery (see following section), unless you have been riding regularly.
7. Store your battery in an easy-to-reach location off the floor, in an area protected from freezing temperatures and direct sunlight.
8. Clean the battery box after removing the battery for storage. Dry the battery box and, if paint is missing, re-paint the area.
9. Slow charge the battery (see following section) once every 30 days.

Battery Charging

Refer to *Safety Precautions* on page 74 .

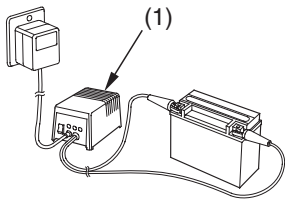

(1) “trickle” charger

Be sure to read the information that came with your battery charger and follow the instructions on the battery. Improper charging may damage the battery.

Battery

We recommend using a “trickle” charger (1) for home charging. These units can be left connected for long periods without risking damage to the battery. However, do not intentionally leave the charger connected longer than the time period recommended in the charger’s instructions.

Avoid using an automotive-type battery charger. An automotive charger can overheat a motorcycle battery and cause permanent damage.

Frequent cleaning and polishing will keep your Honda looking newer longer. Frequent cleaning also identifies you as an owner who values your motorcycle. A clean motorcycle is also easier to inspect and service.

General Recommendations

Refer to *Safety Precautions* on page 74 .

- To clean your motorcycle, you may use:
 - water
 - a mild, neutral detergent and water
 - a mild spray and wipe cleaner/polisher
 - a mild spray and rinse cleaner/degreaser and water

- Avoid products that contain harsh detergents or chemical solvents that could damage the metal, paint, and plastic on your motorcycle.
- If your motorcycle is still warm from recent operation, give the engine and exhaust system time to cool off.
- Park in a shady area. Washing your motorcycle in bright sunlight may cause the finish to fade because water droplets intensify the sun's brightness. Spotting is also more likely because surface water can dry before you have time to wipe it off.
- Clean your motorcycle regularly to protect surface finishes.

(cont'd)

Appearance Care

- We recommend the use of a garden hose to wash your motorcycle. High pressure washers (like those at coin-operated car washes) can damage certain parts of your motorcycle.

NOTICE

High pressure water (or air) can damage certain parts of your motorcycle.

- After cleaning, inspect for damage, wear, and leaks (fuel, oil, coolant, brake, and clutch fluid).

Washing Your Motorcycle with a Mild Detergent

Refer to *Safety Precautions* on page 74 .

1. Rinse your motorcycle thoroughly with cool water to remove loose dirt.
2. Fill a bucket with cool water. Mix in a mild, neutral detergent, such as dish washing liquid or a product made especially for washing motorcycles or automobiles.
3. Wash your motorcycle with a sponge or a soft towel. As you wash, check for heavy grime. If necessary, use a mild cleaner/degreaser to remove the grime.
4. Clean the windscreen with a soft cloth or sponge and plenty of water. Dry with a soft clean cloth. Remove minor

scratches with a commercially-available plastic polishing compound.

Take care to keep brake fluid or chemical solvents off the fairing. They will damage the plastic.

5. Clean the headlight, fairing, meter lens and other plastic parts using a cloth or sponge dampened with a solution of mild detergent and water. When cleaning the plastic headlight lens, use more care because it will scratch easier than a glass lens. Rub any soiled area, gently rinsing it frequently with fresh water.

If the inside of the headlight lens appears clouded immediately after washing, it should clear after a few minutes of riding.

(cont'd)

Appearance Care

6. After washing, rinse your motorcycle thoroughly with plenty of clean water to remove any residue. Detergent residue can corrode alloy parts.
7. Dry your motorcycle with a chamois or a soft towel. Leaving water on the surface to air dry can cause dulling and water spots. As you dry, inspect for chips and scratches.
8. Lubricate the drive chain to prevent rusting.
9. Start the engine and let it idle for several minutes. The engine heat will help dry moist areas.
10. As a precaution, ride your motorcycle at a slow speed and apply the brakes several times. This will help dry the brakes and restore normal braking performance.

Spray Cleaning Your Motorcycle

Refer to *Safety Precautions* on page 74 .

Avoid using spray cleaner products on the tires or suspension components.

Suggestions for using spray cleaner(s) follow:

Appearance Care

Motorcycle Condition	Recommended Cleaning
Dust and fingerprint smudges.	Apply a spray cleaner/polish and wipe the paint, chrome, glass, and clear plastic.
Light road grime.	Spray any difficult-to-reach or very dirty areas with a spray cleaner/degreaser. Rinse and dry. Apply a spray cleaner/polish and wipe with a non-abrasive cloth.
Heavy grime. Oil leaks. Brake dust.	Use a spray cleaner/degreaser. If necessary, rub with a sponge. Rinse and dry. Apply a spray cleaner/polish and wipe with a non-abrasive cloth.
Dull, corroded chrome or aluminum.	Apply a high quality chrome/aluminum polish and wipe with a non-abrasive cloth.

Appearance Care

Painted Aluminum Wheel Maintenance

Refer to *Safety Precautions* on page 74 .

Aluminum may corrode from contact with dirt, mud, or road salt. Clean the wheels after riding through any of these substances. Use a wet sponge and mild detergent. Avoid stiff brushes, steel wool, or cleaners containing abrasives or chemical compounds.

After washing, rinse with plenty of water and dry with a clean cloth.

If the paint is chipped, apply touch-up paint.

Finishing Touches

Refer to *Safety Precautions* on page 74 .

After washing your motorcycle, consider using a commercially-available spray cleaner/polish or quality liquid or paste wax to finish the job. Use only a non-abrasive polish or wax made specifically for motorcycles or automobiles. Apply the polish or wax according to the instructions on the container.

If a surface on your motorcycle is chipped or scratched, your Honda dealer has touch-up paint to match your motorcycle's color. Be sure to use your motorcycle's color code (page 214) when you buy touch-up paint.

If the frame has a chip that exposes the metal, first apply primer (to prevent corrosion) and then apply the touch-up paint. Several thin layers of touch-up paint are better than one thick coat.

Here's a few helpful tips on how to store and transport your Honda, and how to be an environmentally responsible motorcycle owner.

Storing Your Honda	176
Transporting Your Motorcycle	179
You & the Environment	180

Storing Your Honda

If you won't be riding for an extended period, such as during the winter, thoroughly inspect your motorcycle and correct any problem before storing it. That way, needed repairs won't be forgotten and it will be easier to get your motorcycle running again.

For more information about storage, refer to the *Honda Motorcycle Winter Storage Guide*, available from your Honda dealer (USA only).

We suggest you perform the following procedures to keep your motorcycle in top condition. These storage procedures will reduce the deterioration that can occur during storage.

Preparation for Storage

Refer to *Safety Precautions* on page 74 .

1. Change the engine oil and filter (page 109).
2. Make sure the cooling system is filled with a 50/50% antifreeze solution (page 114).
3. Fill the fuel tank. Make sure the fuel fill cap is properly installed.

Storing Your Honda

4. To prevent rusting in the cylinders, perform the following:
 - Remove the ignition coil connectors and ignition coils from the spark plugs. Using tape or string, secure the connectors to any convenient plastic body part so that they are positioned away from the spark plugs.
 - Remove the spark plugs from the engine and store them in a safe place. Do not connect the ignition coils to the ignition coil connectors.
 - Pour a tablespoon (15 – 20 cc) of clean engine oil into each cylinder and cover the spark plug holes with a piece of cloth.
 - With the engine stop switch in the RUN position, press the start button several times to crank the engine and distribute the oil.
- Reinstall the spark plugs, ignition coils and ignition coil connectors.
5. Remove the battery and charge it fully. Store it in an area protected from freezing temperatures and direct sunlight. Slow charge the battery (page 165) once a month.
6. Wash and dry your motorcycle. Wax all painted surfaces. Apply rust-inhibiting oil to the chrome pieces.

(cont'd)

Storing Your Honda

7. Lubricate the drive chain (page 160).
8. Inflate the tires to their recommended pressures (page 148).
9. Store your motorcycle in an unheated area, free of dampness, away from sunlight, with a minimum of daily temperature variation.
10. Place your motorcycle on its center stand. Place a block under the exhaust pipes exposed under the lower fairing to raise the front tire off the floor.
11. Cover your motorcycle with a porous material. Avoid using plastic or similar non-breathing, coated materials that restrict air flow and allow heat and moisture to accumulate.

Removal from Storage

Refer to *Safety Precautions* on page 74 .

1. Uncover and clean your motorcycle.
2. If your motorcycle has been stored for more than four months — change the engine oil (page 109).
3. If your motorcycle has been stored for more than two months — ask your Honda dealer to drain and replace the fuel.
4. Charge the battery (page 165) as required. Install the battery.
5. Lubricate the drive chain (page 160).
6. Perform a pre-ride inspection (page 45), then test-ride your motorcycle at low speeds.

Transporting Your Motorcycle

If your motorcycle needs to be transported, it should be carried on a motorcycle trailer, or a truck or trailer with a flatbed area. For information about 24-hour emergency assistance, see page 241 (USA only). Do not tow your motorcycle, as towing can seriously damage the transmission.

When contacting a towing or transporting service, be sure to ask if they have a flatbed area, a loading ramp or power ramp to safely lift the motorcycle, and motorcycle tie-down straps.

You & the Environment

Owning and riding a motorcycle can be enjoyable, but you must do your part to protect nature.

Following are tips on how you can be an environmentally-responsible motorcycle owner.

- **Choose Sensible Cleaners.** Use a biodegradable detergent when you wash your motorcycle. Avoid aerosol spray cleaners that contain chlorofluorocarbons (CFCs) which damage the atmosphere's protective ozone layer. Don't throw cleaning solvents away; see the following guidelines for proper disposal.

- **Recycle Wastes.** It's illegal and thoughtless to put used engine oil in the trash, down a drain, or on the ground. Used oil, gasoline, coolant, and cleaning solvents contain poisons that can hurt refuse workers and contaminate our drinking water, lakes, rivers, and oceans. Before changing your oil, make sure you have the proper containers. Put oil and other toxic wastes in separate sealed containers and take them to a recycling center. Call your local or state office of public works or environmental services to find a recycling center in your area, and to get instructions on how to dispose of non-recyclable wastes.

Taking Care of the Unexpected

This section discusses the more common problems that can occur with your motorcycle while you're riding. It tells you how to evaluate each problem and what actions you can take to try to resume riding. If the problem cannot be safely solved, this section also gives instructions on the proper way to have your motorcycle transported.

For information about transporting your motorcycle, see page 179 .

General Guidelines	182
If Your Engine Quits or Won't Start	183
If You Have a Flat Tire	188
If Your Engine Overheats	199
If the Low Oil Pressure Indicator Lights	201
If a Fuse Blows.....	202
If You Crash	207
If You Lose Your Key	208
If Your Battery is Low (or Dead)	209

Taking Care of the Unexpected

General Guidelines

Keeping your motorcycle well-maintained is the best way to reduce the possibility of having a problem on the road. However, since problems can arise even with well-maintained machines, you may consider subscribing to an emergency roadside service plan. (USA only: For information about the Honda Rider's Club of America, see page 241 .)

Remember to take along your owner's manual, the tool kit that came with your motorcycle, and any other items (such as tire repair supplies and additional tools) that might help you solve a problem on your own.

Should you ever have a problem while riding, please follow these guidelines:

- Always put personal safety first.
- Take time to assess the situation and your options before deciding what to do.
- If the problem is relatively minor and you have the tools, supplies, and skills to make a temporary repair, be sure to have permanent repairs made as soon as possible.
- Do not continue riding if you are hurt or your motorcycle is not in safe riding condition.

Additional recommendations for specific problems follow.

If Your Engine Quits or Won't Start

Proper operation and maintenance can prevent starting and engine performance problems. In many cases, the cause of the problem may be a simple operational oversight.

If you have a problem starting the engine — or experience poor engine performance — the following information may help you. If you can't correct the problem, see your Honda dealer.

If your motorcycle won't start, listen as you press the start button. If you don't hear the starter motor turning, refer to the *Starter motor doesn't operate* symptom. If you can hear the starter motor working normally, refer to the *Starter motor works, but the engine won't start* symptom.

If Your Engine Quits or Won't Start

SYMPTOM: Starter motor doesn't operate.	
POSSIBLE CAUSE	WHAT TO DO
ignition switch OFF	Turn the ignition switch ON.
engine stop switch OFF	Turn the engine stop switch to RUN.
transmission not in neutral	Shift into neutral.
side stand down (when transmission not in neutral)	Put the transmission in neutral or raise the side stand and pull the clutch lever in.
blown fuse	Replace with a new fuse of the same rating (page 202).
battery lead loose	Tighten the battery lead.
dead battery	Charge the battery (page 165). If charging doesn't help, see your Honda dealer.
faulty starter motor	If all possible causes are negative, the starter motor may be faulty. See your Honda dealer.

If Your Engine Quits or Won't Start

SYMPTOM: Starter motor works, but the engine won't start.	
POSSIBLE CAUSE	WHAT TO DO
out of fuel	Fill the fuel tank.
flooded engine	See <i>Flooded Engine</i> (page 55).
loose or unconnected ignition coil connectors and ignition coils	Install the ignition coil connectors and ignition coils securely. If the engine still won't start, see your Honda dealer.
loose battery cables	Tighten the battery terminal bolts.
weak battery	Charge the battery (page 165). If charging doesn't help, see your Honda dealer.

If Your Engine Quits or Won't Start

SYMPTOM: Engine starts, but stalls as you shift into gear.	
POSSIBLE CAUSE	WHAT TO DO
side stand down	Raise the side stand. Start again.

SYMPTOM: Engine starts, but runs poorly.	
POSSIBLE CAUSE	WHAT TO DO
idles roughly, too fast, stalls	Check engine idle adjustment (page 125). If the problem persists, see your Honda dealer.
overheating	Check the coolant temperature meter. Refer to <i>If Your Engine Overheats</i> , page 199 .
low oil pressure	Check the low oil pressure indicator. Refer to <i>If the Low Oil Pressure Indicator Lights</i> , page 201 .
runs erratically, misfires	See your Honda dealer.
blubbers (rich fuel mixture)	See your Honda dealer.

If Your Engine Quits or Won't Start

SYMPTOM: Engine starts, but runs poorly. (cont'd)	
POSSIBLE CAUSE	WHAT TO DO
sooty exhaust (rich fuel mixture)	See your Honda dealer.
detonates or pings under load	If applicable, switch to the recommended octane gasoline (page 100) or change your brand of gasoline. If the problem persists, see your Honda dealer.
afterfires (backfires)	See your Honda dealer.
pre-ignition (runs on after ignition switched OFF)	See your Honda dealer.

If You Have a Flat Tire

A flat tire is always unwelcome, especially if you are far from help. If you think you are losing air, or you hit a pothole or hard object, pull safely to the side of the road so you can inspect the tires and assess the situation. (Be sure to park on a firm, level surface and use the side stand for support.) You should examine the tire treads and sidewalls for foreign objects or damage. If you find a tire that has been punctured or damaged, you have two options.

Option 1:

Have Your Motorcycle Transported

If a tire has a major puncture or a cut in the tread or sidewall, or the bead has come loose from the rim, there is probably not much you can do except have your motorcycle transported to a Honda dealer

or other qualified service facility. (USA only: For information about 24-hour emergency roadside assistance, see page 241 .) Even with a simple puncture, this may be the safest and least troublesome solution. For transporting instructions, see page 179.

Option 2:

Make a Temporary Roadside Repair

If a tire has only a minor nail puncture and is not completely flat, you may be able to make an emergency repair that could allow you to continue riding to where you can get the tire replaced or permanently repaired.

If You Have a Flat Tire

⚠ WARNING

Riding your motorcycle with a temporary tire repair can be risky. If the temporary repair fails, you can crash and be seriously injured or killed.

If you must ride with a temporary tire repair, ride slowly and carefully and do not exceed 30 mph (50 km/h) until the tire is permanently repaired or replaced.

Due to the uncertainty of any temporary repair, you should ride slowly (not over 30 mph, 50 km/h) and carefully (preferably without a passenger or cargo) until the tire is replaced or permanently

repaired. Stop frequently and check the air pressure. If the tire is losing pressure, it may be unsafe to continue riding. As the tire gets low, it will affect the handling of your motorcycle (especially with a passenger and cargo) and it may overheat and blow out.

Types of Temporary Repairs

The following types of temporary repairs generally require a source of air to inflate the tire. Possible sources include CO₂ cartridges or cans of compressed air designed to inflate a tire.

If You Have a Flat Tire

- **Inflate the tire:** Tubeless tires have some self-sealing ability if they are punctured and the result is usually just a slow leak. If this is the case, you can try inflating the tire to see if it will hold air pressure. If you can see a nail or other object embedded in the tire tread, do not remove it at this time.
- **Plug the hole:** The idea here is to do something to temporarily stop the leak. If you have a tubeless tire repair kit, you can pull out the nail and try inserting an external plug in the puncture. Follow the instructions that came with the repair kit and be sure to inflate the tire to the correct pressure.

Should You Repair or Replace a Tire?

We strongly recommend that you replace, not permanently repair, any tire that is punctured or damaged, even if the tire has only a minor puncture. For a full discussion of repairs and replacement, see page 150.

If You Have a Flat Tire

Emergency Front Wheel Removal/Installation

Refer to *Safety Precautions* on page 74 .

We recommend wheel removal be done only by your Honda dealer or another qualified mechanic. Do not attempt to remove the wheel on your own. Wheel removal requires mechanical skill and professional tools.

Removal

1. Park your motorcycle on its center stand on a firm, level surface.
2. Cover both sides of the front wheel with protective tape (1) or an equivalent.

3. Raise the front wheel off the ground by lowering the center stand (page 64) and placing a support block under the exhaust pipes exposed under the lower fairing.

LEFT SIDE

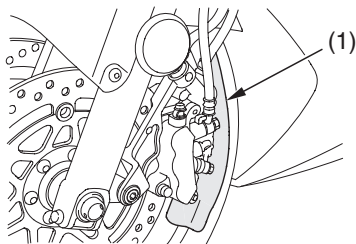

(1) protective tape

(cont'd)

If You Have a Flat Tire

LEFT SIDE

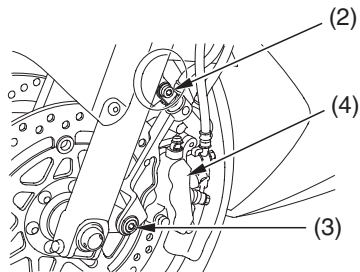

- (2) A socket bolt
- (3) B socket bolt
- (4) left caliper assembly

4. Remove the A (2) and B (3) socket bolts and remove the left caliper assembly (4) from the fork leg.

RIGHT SIDE

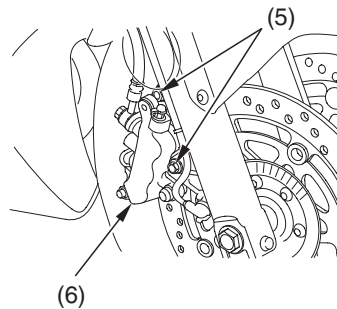

- (5) fixing bolts
- (6) right caliper assembly

If You Have a Flat Tire

- Remove the fixing bolts (5) and remove the right caliper assembly (6).
 - To avoid damage to the brake hose during removal, support the caliper assembly so that it doesn't hang from the hose. Do not twist the brake hose.
 - Avoid getting grease, oil, or dirt on the disc or pad surfaces. Any contamination can cause poor brake performance or rapid pad wear after reassembly.

- Remove the axle bolt (7), and then loosen the right and left axle pinch bolts (8).

RIGHT FRONT

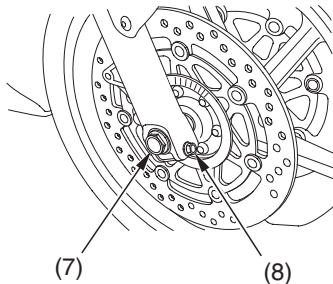

- (7) axle bolt
(8) axle pinch bolt

(cont'd)

If You Have a Flat Tire

- Remove the front axle shaft (9), wheel, and side collar.
 - Avoid depressing the brake lever when the wheel is off the motorcycle. This will force the caliper pistons out of the cylinders. The result will be loss of brake fluid. If this occurs, the brake system will require service. See your Honda dealer for this service.

LEFT FRONT

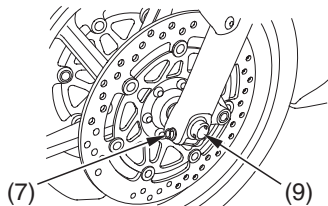

(7) axle pinch bolt (9) front axle shaft

Installation

- Install the side collars and position the wheel between the fork legs. Insert the front axle shaft from the left side, through the left fork leg and wheel hub.
- Align the index line (10) of the front axle shaft with the recessed surface (11) of the fork leg.

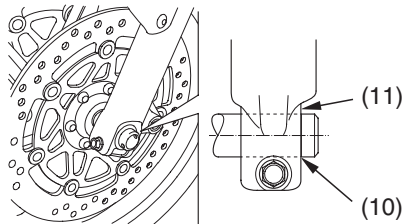

(10) index line

(11) surface

If You Have a Flat Tire

3. Tighten the axle pinch bolt on the left fork leg to the specified torque:
16 lbf·ft (22 N·m , 2.2 kgf·m)
4. Tighten the axle bolt to the specified torque:
43 lbf·ft (59 N·m , 6.0 kgf·m)
5. Install the right and left brake caliper onto the fork leg.
To avoid damaging the brake pads, carefully fits the brake disc (12) between the pads.
6. Install the right caliper fixing bolts and tighten to the specified torque:
23 lbf·ft (31 N·m , 3.2 kgf·m)
7. Install the A and B left caliper socket bolts, and tighten to the specified torque:
23 lbf·ft (31 N·m , 3.2 kgf·m)
8. Operate the front brake and pump the fork several times. Check for free wheel rotation after the brake is released. Recheck the wheel if the brake drags or the wheel does not rotate freely.
9. If the clearances between each surface of the brake disc and the brake bracket (13) (not brake pads) are symmetrical, follow next step.
If the clearances are not symmetrical, loosen the left axle pinch bolt and pull the left fork outward or push inward to adjust the clearance. Then follow the next step.
10. Tighten the axle pinch bolt on the right fork leg to the specified torque:
16 lbf·ft (22 N·m , 2.2 kgf·m)

If You Have a Flat Tire

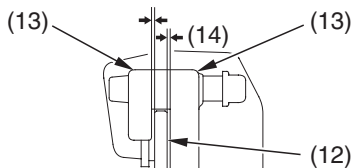

(12) brake disc

(14) clearance

(13) brake bracket

- Visually check that the clearances between each surface of the brake disc and the brake bracket (not brake pads) are symmetrical.
11. After installing the wheel, apply the brake lever AND brake pedal several times, then recheck both discs for caliper holder to disc clearance. Do not operate the motorcycle without adequate clearance.

- Check for free wheel rotation after the brake lever and brake pedal are released. Recheck the wheel if the brake drags or if the wheel does not rotate freely.
- After installing the wheel, operate the brake lever AND brake pedal several times until you feel pressure. You must restore pressure from BOTH the lever AND the pedal because this motorcycle is equipped with a Linked Braking System.
- Verify proper brake operation before riding.

12. Remove the protective tapes from the front wheel.

If You Have a Flat Tire

If a torque wrench was not used for installation, see your Honda dealer as soon as possible to verify proper assembly. Improper assembly may lead to loss of braking capability.

Emergency Rear Wheel Removal/Installation

Refer to *Safety Precautions* on page 74 .

We recommend wheel removal be done only by your Honda dealer or another qualified mechanic. Do not attempt to remove the wheel on your own. Wheel removal requires mechanical skill and professional tools.

Removal

1. Park your motorcycle on its center stand on a firm, level surface.

2. Remove the four rear wheel nuts (1).

RIGHT REAR

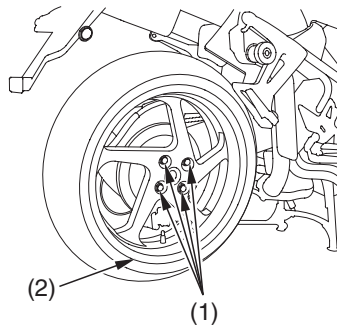

- (1) rear wheel nuts
- (2) rear wheel

3. Remove the rear wheel (2) slowly.

If You Have a Flat Tire

Installation

1. Position the rear wheel and install the rear wheel nuts.
 - Avoid getting grease, oil, or dirt on the disc or pad surfaces. Any contamination can cause poor brake performance or rapid pad wear after reassembly.
2. Tighten the rear wheel nuts to the specified torque:
80 lbf·ft (108 N·m , 11 kgf·m)
3. After installing the wheel, apply the brake several times and then check if the wheel rotates freely. Recheck the wheel if the brake drags or if the wheel does not rotate freely.
4. Operate the brake pedal and check the brake operation.
5. Inspect the brake system (page 146).

If a torque wrench was not used for installation, see your Honda dealer as soon as possible to verify proper assembly. Improper assembly may lead to loss of braking capability.

If Your Engine Overheats

Normally, the coolant temperature on your temperature meter will rise and then level off. Hot weather may cause the temperature to rise higher than normal. So will temporary stress such as climbing a hill. If you're stuck in stop-and-go traffic, the temperature may climb some, but the radiator fan is designed to prevent overheating. Be aware of these variations as you monitor the meter.

If the coolant temperature display begins to flash, a red bar appears on the display and the coolant temperature indicator goes on for no apparent reason, pull safely to the side of the road. If possible, park in a shady area.

NOTICE

Continuing to ride with an overheated engine can cause serious engine damage.

- A steaming engine indicates a coolant leak. Shut the engine off and wait until the steaming stops. Look for a leak, but don't touch the engine or radiator system. Let everything cool off first.
- If there's no obvious problem, leave the engine on so the fan and coolant circulating system can continue working. Monitor the temperature meter. The temperature may drop to the normal range after a brief stop with no load on the engine.

(cont'd)

If Your Engine Overheats

- Check the radiator fan.
If the fan is not working, turn the engine off. Open the fuse box (page 202) and check the radiator fan fuse. If the fuse is blown, replace it with the proper (same rating) spare fuse. Start the engine. If the coolant temperature indicator goes on, the coolant temperature display begins to flash, and a red bar appears and stays on the display, turn the engine off.
If the radiator fan is working, visually check the coolant level in the reserve tank, located behind the left lower fairing (page 115). It isn't necessary to touch the radiator system.
- If the reserve tank is low or empty, don't ride without adding coolant (page 115). After adding coolant, turn the engine on and check the temperature meter.

If the temperature doesn't drop, do not ride. The engine needs repair. Transport your motorcycle to a Honda dealer (page 179).

If the temperature drops to normal, check the coolant level. If it has gone down, add more coolant.

If you are able to resume riding, continue to monitor the meter frequently.

If there's a mild leak, you can ride for awhile, carefully watching the meter. Be prepared to stop and add more coolant or water. If the leak is bad, transport your motorcycle to a Honda dealer (page 179).

If the Low Oil Pressure Indicator Lights

If you check your engine oil level regularly, you should never see the low oil pressure indicator while riding. Normally, it will only light momentarily when you turn the ignition switch ON. Occasionally, it may flicker at or near idling speed.

Low oil pressure may be caused by an oil leak, a low oil level, or some problem in the engine's lubrication system.

If the indicator comes on while you're riding, don't ignore it. Pull safely to the side of the road. If possible, pull the clutch lever in and coast to a stop. Stop the engine as soon as it's safe to do so.

NOTICE

Continuing to ride with low oil pressure can cause serious engine damage.

- Check for an oil leak.
- Then check the oil level. If necessary, add the recommended oil (page 105) to the upper level mark. If you must leave your motorcycle to get oil, secure it as much as possible.
- After adding oil, start the engine, and check that the low oil pressure indicator goes off. Check for a possible leak.

If the indicator goes off and there is no leak — resume riding. If there is a leak — do not ride the motorcycle until the leak is repaired by a Honda dealer.

If a Fuse Blows

All of the electrical circuits on your motorcycle have fuses to protect them from damage caused by excess current flow (short circuit or overload).

If something electrical on your motorcycle stops working, the first thing you should check for is a blown fuse.

Determine from the chart on the circuit fuse box cover which fuse or fuses control that component. Check those fuses first, but check all the fuses before looking elsewhere for another possible cause of the problem. Replace any blown fuses and check component operation.

- Main fuse A (and spare) are located on the starter motor magnetic switch (3) under the seat.
- Main fuse B is located under the seat.

- (INTERCEPTOR)

The circuit fuse box (including spare fuse) is located under the right inner panel.

(INTERCEPTOR ABS)

The circuit fuse boxes (including spare fuses) are located under the left and right inner panels.

Recommended Fuses

main fuse A	30A
main fuse B	30A
other fuses	10A, 20A 30A (INTERCEPTOR ABS ONLY)

If a Fuse Blows

1. To prevent an accidental short circuit, turn the ignition switch OFF before checking or replacing the fuses.
2. Remove the seat (page 90).

UNDER SEAT

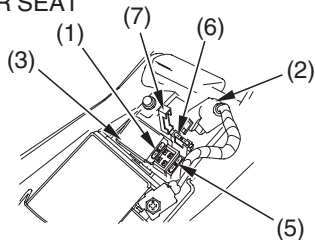

- (1) main fuse A
- (2) wire connector
- (3) starter magnetic switch
- (4) spare main fuse A
- (5) main fuse B
- (6) main fuse B cover
- (7) main fuse B cover

Main Fuse Access:

3. To access the main fuse A (1), disconnect the wire connector (2) of the starter magnetic switch (3).
4. Pull main fuse A out.
If it is blown (4), install spare main fuse A (5).

MAIN FUSE A, B

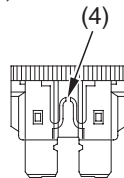

- (4) blown fuse

(cont'd)

If a Fuse Blows

5. Reconnect the wire connector.
6. To access main fuse B (6), open the main fuse B cover (7).
7. Pull main fuse B out.
If it is blown, install a new main fuse B.
8. Close the main fuse B cover.
9. Install the seat.

Circuit Fuse Access:

10. Remove the inner panel (page 96).
11. Open the fuse box cover (8).

RIGHT FRONT

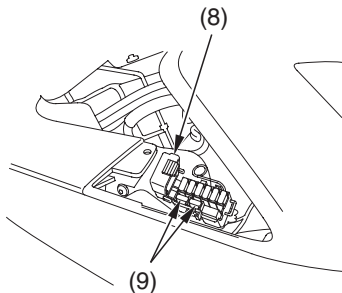

- (8) cover
(9) spare fuses

If a Fuse Blows

LEFT FRONT (INTERCEPTOR ABS only)

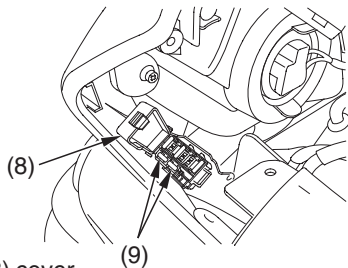

- (8) cover
(9) spare fuses

12. To check or replace a circuit fuse, pull the old fuse out of its retaining clips. Look for a burned wire inside the fuse. If the fuse is blown (10), replace it with a spare fuse (9) of the same rating or lower.

CIRCUIT FUSE

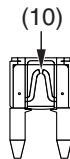

- (10) blown fuse

13. Close the fuse box cover.
14. Install the inner panel.

If you do not have a replacement fuse with the proper rating for the circuit, install one with a lower rating.

NOTICE

Replacing a fuse with one that has a higher rating greatly increases the chance of damage to the electrical system.

If a Fuse Blows

If you do not have a spare fuse and you cannot ride the motorcycle without fixing the problem, take a fuse of the same rating or a lower rating from one of the other circuits that you can do without temporarily.

If you replace a blown fuse with a spare fuse that has a lower rating, replace the fuse with the correct rating as soon as you can. Also remember to replace any spare fuses that were installed.

If the replacement fuse of the same rating burns out in a short time, there is probably a serious electrical problem on your motorcycle. Leave the blown fuse in that circuit and have your motorcycle checked by your Honda dealer.

Personal safety is your first priority after any accident. If you or anyone else has been injured, take time to assess the severity of the injuries and whether it is safe to continue riding. Call for emergency assistance if needed. Also follow applicable laws and regulations if another person or vehicle is involved in the accident.

If you decide you are capable of riding safely, carefully inspect your motorcycle for damage and determine if it is safe to ride. Check the tightness of critical nuts and bolts securing such parts as the handlebar, control levers, brakes, and wheels.

If there is minor damage, or you are unsure about possible damage, ride slowly and cautiously. Sometimes, crash damage is hidden or not immediately apparent, so you should have your motorcycle thoroughly checked at a qualified service facility as soon as possible. Also, be sure to have your Honda dealer check the frame and suspension after any serious crash.

If your motorcycle cannot be ridden, see *Transporting Your Motorcycle*, page 179.

If You Lose Your Key

Be sure to record your key number in the Quick Reference section at the rear of the manual. You'll need this number to have a duplicate key made.

A lost key won't be a problem if you take preventative action. Store one duplicate key in a safe place at home and carry a second duplicate in your wallet.

If you lose your key and aren't carrying a duplicate, either get your spare or have one made. If you don't know your key number, call the dealer you purchased your Honda from. They may have it listed in their records. If they don't, transport your motorcycle to them or the nearest Honda dealer. The dealer will probably have to remove the ignition switch assembly to find the key number so they can make a key for you.

If Your Battery Is Low (or Dead)

Jump starting is not recommended, especially if you use an automobile battery. The greater amperage of an automobile battery when the car engine is running can damage your motorcycle's electrical system.

Bump starting is also not recommended.

If you can't charge the battery or it appears unable to hold a charge, contact your Honda dealer.

Technical Information

This section contains dimensions, capacities, and other technical data, plus information on government requirements and how to break-in your motorcycle.

Vehicle Identification.....	212
Specifications	215
Break-in Guidelines.....	222
Emission Control Systems	223
Catalytic Converter	229
Oxygenated Fuels	230

Vehicle Identification

Serial Numbers

The frame, VIN, and engine serial numbers are required when you register your motorcycle. They may also be required when ordering replacement parts. You may record these numbers in the Quick Reference section at the rear of this manual.

The VIN (vehicle identification number) appears on the Safety Certification Label attached to the left side of the frame.

LEFT SIDE

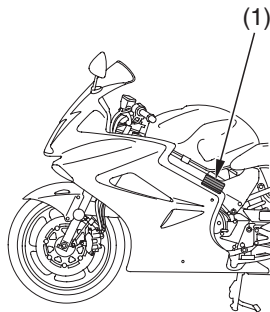

(1) VIN

Vehicle Identification

The frame number (2) is stamped on the right side of the steering head.

RIGHT SIDE

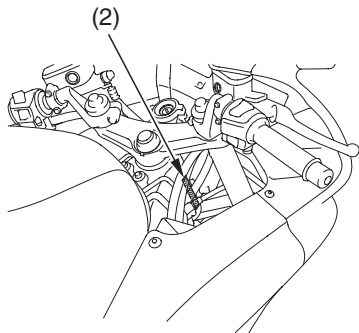

(2) frame number

The engine number (3) is stamped on the top of the crankcase.

LEFT SIDE

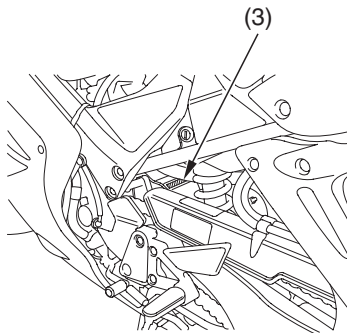

(3) engine number

Vehicle Identification

Color Label & Code

The color label is attached to the frame under the seat. Remove the seat (page 90) to check the label.

The color code is helpful when ordering replacement parts. You may record the color and code in the Quick Reference section at the rear of this manual.

UNDER SEAT

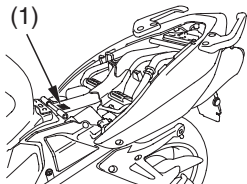

(1) color label

Specifications

Dimensions	
overall length	83.5 in (2,120 mm)
overall width	28.9 in (735 mm)
overall height	47.0 in (1,195 mm)
wheelbase	57.5 in (1,460 mm)
ground clearance	4.9 in (125 mm)

Specifications

Fuel & Lubricants	
fuel recommendation	unleaded gasoline, pump octane number of 86 or higher
fuel tank capacity	5.81 US gal (22.0 ℓ)
engine oil capacity	after disassembly: 4.0 US qt (3.8 ℓ) after draining: 3.1 US qt (2.9 ℓ) after draining & oil filter change: 3.3 US qt (3.1 ℓ)
engine oil recommendation	API Service Classification SG or higher except oils labeled as energy conserving on the circular API service label, SAE 10W-40, JASO T 903 standard MA, Pro Honda GN4 or HP4 (without molybdenum additives) 4-stroke oil (USA & Canada) or Honda 4-stroke oil (Canada only), or an equivalent motorcycle oil
drive chain lubricant	SAE 80 or 90 gear oil
cooling system, recommendation	Pro Honda HP Coolant or an equivalent high quality ethylene glycol antifreeze containing corrosion protection inhibitors specifically recommended for use in aluminum engines
cooling system, capacity	3.09 US qt (2.92 ℓ)

Specifications

Capacities	
passenger capacity	Operator and one passenger
maximum weight capacity	USA: 399 lbs (181 kg) Canada: 408 lbs (185 kg) rider, passenger, all cargo and accessories

Engine Specifications	
displacement	47.7 cu-in (782 cm ³)
bore & stroke	2.83 x 1.89 in (72.0 x 48.0 mm)
compression ratio	11.6 : 1
spark plug (standard)	IMR9B – 9H (NGK) or VNH27Z (DENSO)
spark plug (cold climate)	IMR8B – 9H (NGK) or VNH24Z (DENSO)
spark plug gap	0.031 – 0.035 in (0.80 – 0.90 mm) no adjustment
valve clearance (cold)	intake 0.008 in (0.20 mm) exhaust 0.014 in (0.35 mm)
idle speed	1,200 ± 100 rpm

Specifications

Power Transmission	
primary reduction	1.939
gear ratio, 1st	2.846
2nd	2.062
3rd	1.578
4th	1.291
5th	1.111
6th	0.965
final reduction	2.687
standard sprocket sizes	drive (engine) sprocket: 16 driven (rear wheel) sprocket: 43
final drive	chain DID50VA8 or RK50HFOZ5

Specifications

Chassis & Suspension	
caster	25°30'
trail	3.7 in (95 mm)
tire size, front	120/70ZR17M/C (58W)
tire size, rear	180/55ZR17M/C (73W)
tire type	radial – ply, tubeless
tire pressure, front (cold)	36 psi (250 kPa , 2.50 kgf/cm ²)
tire pressure, rear (cold)	42 psi (290 kPa , 2.90 kgf/cm ²)

Electrical	
battery	12V – 10Ah or 12V – 11Ah
generator	0.497kW/5,000rpm

Specifications

Lights	
headlight	12V – 55W (4 bulbs)
brake/tail light	12V – 21/5W (2 bulbs)
turn signal lights	12V – 21W (front) 12V – 21W (rear)
license light	12V – 8W

Specifications

Fuses	
main A	30A
main B	30A
other fuses	10A, 20A, 30A (INTERCEPTOR ABS ONLY)

Torque Specifications	
engine oil drain bolt	22 lbf·ft (30 N·m , 3.1 kgf·m)
engine oil filter	20 lbf·ft (26 N·m , 2.7 kgf·m)
front wheel axle bolt	43 lbf·ft (59 N·m , 6.0 kgf·m)
front wheel caliper fixing bolts	23 lbf·ft (31 N·m , 3.2 kgf·m)
front wheel caliper socket bolts	23 lbf·ft (31 N·m , 3.2 kgf·m)
front wheel axle pinch bolts	16 lbf·ft (22 N·m , 2.2 kgf·m)
rear wheel nuts	80 lbf·ft (108 N·m , 11 kgf·m)

Break-in Guidelines

Help assure your motorcycle's future reliability and performance by paying extra attention to how you ride during the first 300 miles (500 km).

During this period, avoid full-throttle starts and rapid acceleration.

Emission Control Systems

Exhaust Emission Requirements

The U.S. Environmental Protection Agency (EPA), the California Air Resources Board (CARB), and Environment Canada require that your motorcycle comply with applicable exhaust emissions standards during its useful life, when operated and maintained according to the instructions provided.

Noise Emission Requirements

The EPA also requires that motorcycles built after January 1, 1983 comply with applicable noise emission standards for one year or 3,730 miles (6,000 km) after the time of sale to the ultimate purchaser, when operated and maintained according to the instructions provided. (USA only)

Warranty Compliance

Compliance with the terms of the Distributor's Warranties for Honda Motorcycle Emission Control Systems is necessary in order to keep the emissions system warranty in effect. (USA only)

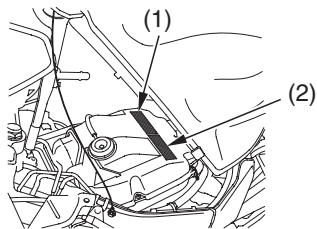

- (1) vehicle emission control information label
- (2) vehicle emission control information label (Canada only)

Emission Control Systems

The Vehicle Emission Control Information label (1) (2) is attached to the air cleaner housing under the fuel tank.

Source of Exhaust Emissions

The combustion process produces carbon monoxide (CO), oxides of nitrogen (NOx) and hydrocarbons (HC). Control of hydrocarbons and oxides of nitrogen is very important because, under certain conditions, they react to form photochemical smog when subjected to sunlight. Carbon monoxide does not react in the same way, but it is toxic.

Honda Motor Co., Ltd. utilizes various systems to reduce carbon monoxide, oxides of nitrogen and hydrocarbons.

Exhaust Emission Control System

The exhaust emission control system includes a secondary air injection system, PGM-FI system, two three-way catalytic converters, and two heated oxygen sensors.

No adjustment to these systems should be made although periodic inspection of the components is recommended.

PGM-FI System

The PGM-FI system uses sequential multiport fuel injection. It has four subsystems: Air Intake, Engine Control, Fuel Control, and Exhaust Control.

The Engine Control Module (ECM) uses various sensors to determine how much air is going into the engine. It then controls how much fuel to inject under all operating conditions.

Ignition Timing Control System

The system constantly adjusts the ignition timing, reducing the amount of HC, CO and NO_x produced.

Emission Control Systems

Secondary Air Injection System

The secondary air injection system introduces filtered air into the exhaust gases in the exhaust port. The secondary air injection system helps improve emission performance.

Three-Way Catalytic Converters

The three-way catalytic converters are in the exhaust system. Through chemical reactions, they convert HC, CO, and NO_x in the engine's exhaust to carbon dioxide (CO₂), nitrogen (N), and water vapor.

Evaporative Emission Control System (USA only)

This motorcycle complies with the requirements of the California Air Resources Board (CARB) evaporative emission regulations. Fuel vapor from the fuel tank is directed into the charcoal canister and air cleaner where it is adsorbed and stored while the engine is stopped. When the engine is running and the purge control solenoid valve is open, fuel vapor in the charcoal canister and air cleaner is drawn into the engine through the throttle body.

Crankcase Emission Control System

The engine is equipped with a closed crankcase system to prevent discharging crankcase emissions into the atmosphere. Blow-by gas is returned to the combustion chamber through the air cleaner and the intake manifold.

Problems That May Affect Motorcycle Exhaust Emissions

If you are aware of any of the following symptoms, have the vehicle inspected and repaired by your authorized Honda motorcycle dealer.

Symptoms:

1. Hard starting or stalling after starting
2. Rough idle
3. Misfiring or backfiring during acceleration
4. After-burning (backfiring)
5. Poor performance (driveability) and poor fuel economy

Emission Control Systems

Noise Emission Control System

TAMPERING WITH THE NOISE CONTROL SYSTEM IS PROHIBITED:

U. S. federal law prohibits, or Canadian provincial laws may prohibit the following acts or the causing thereof: (1) The removal or rendering inoperative by any person, other than for purposes of maintenance, repair or replacement, of any device or element of design incorporated into any new vehicle for the purpose of noise control prior to its sale or delivery to the ultimate purchaser or while it is in use; or (2) the use of the vehicle after such device or element of design has been removed or rendered inoperative by any person.

AMONG THOSE ACTS PRESUMED TO CONSTITUTE TAMPERING ARE THE FOLLOWING ACTS:

1. Removal of, or puncturing the muffler, baffles, header pipes or any other component which conducts exhaust gases.
2. Removal of, or puncturing of any part of the intake system.
3. Lack of proper maintenance.
4. Replacing any moving parts of the vehicle, or parts of the exhaust or intake system, with parts other than those specified by the manufacturer.

Catalytic Converter

This motorcycle is equipped with two three-way catalytic converters. The catalytic converter contains precious metals that serve as catalysts, promoting chemical reactions to convert the exhaust gasses without affecting the metals.

The catalytic converters act on HC, CO, and NO_x. A replacement unit must be an original Honda part or its equivalent.

The catalytic converters must operate at a high temperature for the chemical reactions to take place. They can set fire to any combustible materials that come near them. Park your motorcycle away from high grasses, dry leaves, or other flammables.

A defective catalytic converter contributes to air pollution, and can impair your engine's performance. Follow these guidelines to protect your motorcycle's catalytic converter.

- Always use unleaded gasoline. Even a small amount of leaded gasoline can contaminate the catalyst metals, making the catalytic converter ineffective.
- Keep the engine tuned-up.
- Have your motorcycle diagnosed and repaired if it is misfiring, backfiring, stalling or otherwise not running properly.

Oxygenated Fuels

Some conventional gasolines are being blended with alcohol or an ether compound. These gasolines are collectively referred to as oxygenated fuels. To meet clean air standards, some areas of the United States and Canada use oxygenated fuels to help reduce emissions. If you use an oxygenated fuel, be sure it is unleaded and meets the minimum octane rating requirement.

Before using an oxygenated fuel, try to confirm the fuel's contents. Some states/provinces require this information to be posted on the pump.

The following are the EPA-approved percentages of oxygenates:

ETHANOL (ethyl or grain alcohol) 10%
by Volume

You may use gasoline containing up to 10% ethanol by volume. Gasoline containing ethanol may be marketed under the name "Gasohol".

MTBE (Methyl Tertiary Butyl Ether) 15%
by Volume

You may use gasoline containing up to 15% MTBE by volume.

METHANOL (methyl or wood alcohol)
5% by Volume

You may use gasoline containing methanol containing up to 5% methanol by volume as long as it also contains cosolvents and corrosion inhibitors to protect the fuel system. Gasoline containing more than 5% methanol by volume may cause starting and/or performance problems. It may also damage metal, rubber, and plastic parts of your fuel system.

If you notice any undesirable operating symptoms, try another service station or switch to another brand of gasoline.

Fuel system damage or performance problems resulting from the use of an oxygenated fuel containing more than the percentages of oxygenates mentioned above are not covered under warranty.

Oxygenated fuels can damage paint and plastic. Be careful not to spill fuel when filling the fuel tank. Wipe up any spills immediately.

NOTICE

Oxygenated fuels can damage paint and plastic. Damage caused by spilled fuel is not covered by warranty.

Consumer Information

This section contains information on your warranty and how to get an official Honda service manual.

Authorized Manuals	234
Warranty Coverage	237
Warranty Service	238
Contacting Honda.....	239
Your Honda Dealer	240
The Honda Rider's Club (USA only)	241
Reporting Safety Defects (USA only)	242

Authorized Manuals

The Service Manual used by your authorized Honda dealer is available from Helm, Inc. (USA only, Canada: See your Honda dealer to order authorized manuals.)

Also available but not necessary to service your model is the Honda Common Service Manual which explains theory of operation and basic service information for various systems common to all Honda motorcycles, motor scooters and ATVs.

These Honda manuals are written for the professional technician, but most mechanically-capable owners should find them easy to use if they have the proper tools and observe proper safety standards. Special Honda tools are necessary for some procedures.

Publication Item No.	Description	Price Each*
61MCW04	2006 VFR800/A INTERCEPTOR/ABS Service Manual	\$60.00
61CM002	Common Service Manual	\$48.00
31MCW640	2006 VFR800/A INTERCEPTOR/ABS Owner's Manual	\$16.00
<i>* Prices are subject to change without notice and without incurring obligation.</i>		

Order On-Line: www.helminc.com

Order Toll Free: 1-888-CYCLE93 (1-888-292-5393)

(NOTE: For Credit Card Orders Only)

Monday — Friday 8:00 AM — 6:00 PM EST

OR

By completing this form you can order the materials desired. You can pay by check or money order, or charge to your credit card. Mail to Helm, Inc. at the address shown on the back of this order form (USA only).

Canada: See your Honda dealer to order authorized manuals.

Publication Item No.	Item Description	Qty.	Price Each*	Total Price
*Prices are subject to change without notice and without incurring obligation. Orders are mailed within 10 days. Please allow adequate time for delivery.		Sub Total		
		Purchaser's Sales Tax		
		Mich. Add 6 %		
		Calif. Add 8.25 %		
		Handling Charge		\$5.00
		Grand Total		

SHIP TO

NOTE: Dealers and Companies please provide dealer or company name, and also the name of the person to whose attention the shipment should be sent.

Customer Name _____ Attention _____

Street Address - No P. O. Box Number _____ Apartment Number _____

City _____ State _____ Zip Code _____

Daytime Telephone Number () _____

PAYMENT

Check or money order enclosed payable to Helm Inc.
U.S. funds only. Do not send cash.

Check here if your billing address is different from the
shipping address shown above.

MasterCard

Account Number

--	--	--	--	--	--	--	--	--	--	--	--	--	--	--	--	--	--	--	--

Expiration: Mo. Yr.

--	--

VISA

Discover

Customer Signature _____ Date _____

These Publications cannot be returned for credit without receiving advance authorization within 14 days of delivery. On returns, a restocking fee may be applied against the original order.

HELM P.O. BOX 07280, DETROIT, MICHIGAN 48207

Warranty Coverage

Your new Honda is covered by these warranties:

- Motorcycle Limited Warranty
- Exhaust Emission Warranty
- Noise Control Warranty

There are responsibilities, restrictions, and exclusions which apply to these warranties. Please read the Warranties Booklet given to you by your Honda dealer at the time of purchase. Be sure to keep your Honda owner's card with your Warranties Booklet (USA only).

It is important to realize that your warranty applies to defects in material or workmanship of your Honda. Your warranty coverage does not apply to normal wear or deterioration associated with using the motorcycle.

Your warranty coverage will not be voided if you choose to perform your own maintenance. However, you should have the proper tools and service information and be mechanically qualified. Failures that occur due directly to improper maintenance are not covered.

Almost all of your warranty coverage can be extended through the Honda Protection Plan (USA only). For more information, see your Honda dealer.

Warranty Service

Please remember that recommended maintenance interval servicing is not included in your warranty coverage. Additionally, your warranty does not apply to the normal wear of items (such as brakes, tires, etc.).

If you believe you have a problem with your motorcycle, call the service department of your Honda dealer. Make an appointment for an inspection and diagnosis. Remember, as the owner of the motorcycle, you will be asked to authorize that inspection. Your dealer will give you the results of the inspection. If the problem is covered under warranty, your dealer will perform the warranty repairs for you.

If you have questions about warranty coverage or the nature of the repair, it is best to talk to the service manager of your Honda dealer.

Sometimes, in spite of the best intentions of all concerned, a misunderstanding may occur. If you aren't satisfied with your dealer's handling of the situation, we suggest you discuss your problem with the appropriate member of the dealership's management team. If the problem has already been reviewed with the Service Manager, Parts Manager, Sales Manager, etc., contact the Owner of the dealership or their designated representative.

Your owner's manual was written to cover most of the questions you might ask about your Honda. Any questions not answered in the owner's manual can be answered by your Honda dealer. If your dealer doesn't have the answer right away, they will get it for you.

If you have a difference of opinion with your dealer, please remember that each dealership is independently owned and operated. That's why it's important to work to resolve any differences at the dealership level.

If you wish to comment on your experiences with your Honda or with your dealer, please send your comments to the following address (USA only):

Motorcycle Division, American Honda Motor Co., Inc., P.O. Box 2220, Torrance, CA 90509-2220, mailstop: 100-4C-7B, telephone: (866) 784-1870.

Canada: Refer to the Warranties Booklet that was supplied with your vehicle.

Please include the following information in your letter:

- name, address, and telephone number
- product model, year, and frame/VIN serial number
- date of purchase
- dealer name and address

We will likely ask your Honda dealer to respond, or possibly acknowledge your comments directly.

Your Honda Dealer

Once you purchase your new Honda, get familiar with the organization of your Honda dealer so you can utilize the full range of services available.

The service department is there to perform regular maintenance and unexpected repairs. It has the latest available service information from Honda. The service department will also handle warranty inspections and repairs.

The parts department offers Genuine Honda parts, Pro Honda products, Hondaline accessories (USA only), and Honda accessories and products (Canada only). The same quality that went into your Honda can be found in Genuine Honda replacement parts. You'll also find comparable quality in the accessories and

products available from the parts department.

The sales department offers the Honda Protection Plan to extend almost all of your warranty coverage (USA only). Your Honda dealer can inform you about competition and other riding events in your area. You'll also find that your dealer is a source of information about American Honda's Rider Education Centers and the Honda Rider's Club of America (USA only).

We're sure you'll be as pleased with the service your Honda dealer continues to provide after the sale as you are with the quality and dependability of your Honda.

The Honda Rider's Club (USA only)

One of the best ways to get the most enjoyment from owning and riding your Honda is through the Honda Rider's Club of America. Your purchase of a new motorcycle, scooter, ATV or PWC from a participating U.S. Honda dealer entitles you to a complimentary one-year membership in the Club. There are hundreds of HRCA Chapter sponsoring dealers across the USA with events and activities almost every weekend.

Membership benefits include:

- 24 hour, toll-free roadside assistance for your new Honda (includes roadside assistance for your transport vehicle as long as your Honda is aboard or in tow).
- Vehicle transport to the nearest Honda dealer or service center, if necessary.
- An exclusive HRCA website complete with access to the official Honda

Common Service Manual, contests, insider information and more.

- Reimbursement (up to \$75) for Motorcycle Safety Foundation training. Separate free training from the Specialty Vehicle Institute of America for ATV owners.
- One full year of the *Honda Red Rider* magazine or *Honda Red Rider ATV* (for ATV purchasers).
- Discounts from HRCA partners for experienced rider courses.
- Discounted vehicle insurance from the HRCA's insurance partner.
- Racing contingency programs and assistance at selected dual-sport, off-road, and motocross events.

Contact your Honda dealer for more information or call: 1 800-847-HRCA or log on to www.hrca.honda.com.

Reporting Safety Defects (USA only)

If you believe that your vehicle has a defect which could cause a crash or could cause injury or death, you should immediately inform the National Highway Traffic Safety Administration (NHTSA) in addition to notifying American Honda Motor Co., Inc.

If NHTSA receives similar complaints, it may open an investigation, and if it finds that a safety defect exists in a group of vehicles, it may order a recall and remedy campaign. However, NHTSA cannot become involved in individual problems between you, your dealer, or American Honda Motor Co., Inc.

To contact NHTSA, you may call the Vehicle Safety Hotline toll-free at 1-800-327-4236 (TTY: 1-800-424-9153); go to <http://www.safercar.gov>; or write to: Administrator, NHTSA, 400 Seventh Street, SW., Washington, DC. 20590.

You can also obtain other information about motor vehicle safety from <http://www.safercar.gov>.

Table of Contents

The following presents the contents of each section of your owner's manual.

MOTORCYCLE SAFETY	1
Important Safety Information	2
Accessories & Modifications	5
Safety Labels	7
INSTRUMENTS & CONTROLS	9
Operation Component Locations	11
Gauges, Indicators & Displays.....	14
Multi-function Display.....	24
Fuel Gauge.....	25
Coolant Temperature Meter.....	26
Air Temperature Meter	28
Speedometer	30
Odometer	30
Tripmeter A & B	31
Changing the Speed and Mileage	
Unit	32

Digital Clock	33
Controls & Features	
Ignition Switch	35
Start Button.....	36
Engine Stop Switch	36
Hazard Switch	37
Headlight Dimmer Switch	38
Turn Signal Switch.....	38
Horn Button	39
SELECT Button	39
RESET Button.....	39
BEFORE RIDING.....	41
Are You Ready to Ride ?	42
Protective Apparel.....	42
Rider Training	44
Is Your Motorcycle Ready to Ride ?	45
Pre-ride Inspection	45
Load Limits & Guidelines.....	48
Loading	48

Table of Contents

Load Limits	49
Loading Guidelines	49
BASIC OPERATION & RIDING.....	51
Safe Riding Precautions	52
Starting & Stopping the Engine	53
Preparation.....	53
Starting Procedure	54
Flooded Engine.....	55
Bank Angle Sensor Ignition Cut-off System.....	55
How to Stop the Engine	56
Shifting Gears.....	57
Braking	59
Anti-lock Brake System (ABS) (INTERCEPTOR ABS).....	61
ABS Indicator (INTERCEPTOR ABS).....	62
Parking.....	63
Riding with a Passenger or Cargo.....	68

SERVICING YOUR HONDA	69
<i>Before You Service Your Honda</i>	
The Importance of Maintenance.....	72
Maintenance Safety	73
Important Safety Precautions.....	74
Periodic Maintenance.....	76
Maintenance Schedule	78
Maintenance Record.....	83

Service Preparations

Maintenance Component Locations	85
Tool Kit.....	88
Owner's Manual Storage.....	89
Seat Removal.....	90
Rear Seat Cover.....	91
Lower Fairing Removal	93
Inner Fairing Removal	95
Inner Panel Removal	96

(cont'd)

Table of Contents

SERVICING YOUR HONDA (cont'd)

Clip Removal.....	97
Raising the Fuel Tank	98

Service Procedures

Fluids & Filters

Fuel	100
Engine Oil & Filter.....	104
Coolant.....	114
Air Cleaner	118

Engine

Throttle	120
Clutch System.....	122
Engine Idle Speed.....	125
Spark Plugs	127

Chassis

Suspension	134
Brakes	141
Tires	147
Side Stand	154
Drive Chain.....	155

Electrical

Battery.....	162
--------------	-----

Appearance Care	167
-----------------------	-----

TIPS..... 175

Storing Your Honda	176
Transporting Your Motorcycle	179
You & the Environment	180

Table of Contents

TAKING CARE OF THE UNEXPECTED	181
General Guidelines	182
If Your Engine Quits or Won't Start ...	183
If You Have a Flat Tire	188
If Your Engine Overheats	199
If the Low Oil Pressure Indicator Lights	201
If a Fuse Blows.....	202
If You Crash	207
If You Lose Your Key	208
If Your Battery is Low (or Dead)	209
TECHNICAL INFORMATION	211
Vehicle Identification.....	212
Specifications	215
Break-in Guidelines.....	222
Emission Control Systems	223
Catalytic Converter	229
Oxygenated Fuels	230

CONSUMER INFORMATION	233
Authorized Manuals	234
Warranty Coverage	237
Warranty Service	238
Contacting Honda.....	239
Your Honda Dealer	240
The Honda Rider's Club (USA only)	241
Reporting Safety Defects (USA only)	242
TABLE OF CONTENTS	244
INDEX	248
QUICK REFERENCE	

Index

A

ABS indicator (INTERCEPTOR ABS)	62
accessories	5
air pressure, tires.....	147
air temperature meter.....	28
American Honda, contacting.....	239
anti-lock brake system (ABS) (INTERCEPTOR ABS)	61
apparel, protective	42
appearance care	167

B

bank angle sensor	55
battery	162
brakes, fluid.....	142

front lever adjustment	141
pad wear.....	145
braking	59
break-in guidelines	222
button, RESET	39
SELECT	39

C

capacity, fuel	102
care, appearance	167
catalytic converter	229
chain, drive	155
cleaning, appearance care	167
clip.....	97
clock, digital	33
clutch system	122
color label	214

compartment,	
owner's manual	89
tool kit.....	88
consumer information	233
coolant.....	114
coolant temperature meter.....	26
cover,	
rear seat.....	91
customer service	239

D

damping, suspension, rear	140
defects, safety	242
digital clock	33
display,	
check.....	16
multi-function.....	24
drive chain	155

E

emission control systems.....	223
engine,	
flooded.....	55
idle speed.....	125
low oil pressure.....	201
number	213
oil	104
overheats.....	199
pinging	101
starting	53
stop switch	36
stopping.....	56
won't start.....	183
environment.....	180

Index

F

- fairing removal,
 - inner 95
 - lower 93
- flat tire..... 188
- flooded engine 55
- frame number 213
- fuel,
 - gauge..... 25
 - oxygenated..... 230
 - recommendation 100
 - tank raising 98
 - tank capacity 102
- fuses 202

G

- gap, spark plug..... 131

250 Index

- gasohol 230
- gasoline 100
- gauges, indicators & displays..... 14

H

- hazard switch 37
- headlight dimmer switch 38
- helmet holder 65
- high beam indicator 18
- Honda,
 - contacting 239
 - Rider's Club..... 241
 - dealer..... 240
- Honda service manual 234
- horn button..... 39

I

- identification, vehicle..... 212

idle speed, engine	125
ignition cutoff system,	
bank angle.....	55
side stand	53
ignition switch	35
indicators.....	14
inner fairing removal.....	95
inner panel removal.....	96
inspection, pre-ride	45

K

key, lost.....	208
kit, tool.....	88

L

labels, safety	7
lamp check.....	15
limit, weight.....	49

load limits	49
loading guidelines.....	49
lock, steering.....	64
lower fairing removal.....	93

M

maintenance,	
importance	72
periodic	76
record	83
safety.....	73
schedule	78
manual, service.....	234
maximum weight limit	49
modifications	6

Index

N

numbers, serial..... 212

O

odometer 14, 30

oil,

 engine..... 105

 low pressure..... 201

operating controls 35

overheat, engine..... 199

owner's manual storage..... 89

oxygenated fuels..... 230

P

parking 63

pinging, engine 101

plugs, spark..... 127

pre-load, suspension

 front 136

 rear 138, 139

pre-ride inspection 45

problems, unexpected..... 181

protective apparel 42

R

removal,

 inner fairing 95

 inner panel 96

 lower fairing 93

 rear seat cover..... 91

 seat 90

reporting safety defects 242

RESET button..... 39

rider training 2, 44

Rider's Club, Honda..... 241

riding,	
basic operation.....	51
clothing	42
precautions.....	52
safety.....	2
safety precautions.....	52
with passenger or cargo.....	68

S

safety,	
important precautions.....	74
labels	7
reporting defects.....	242
riding precautions	52
schedule, maintenance.....	78
seat removal.....	90
SELECT button	39
sensor, bank angle	55
serial numbers.....	212

service,	
customer.....	239
manuals	234
warranty	238
shifting gears	57
side stand	154
side stand ignition cutoff system	53
spark knock.....	101
spark plugs.....	127
specifications.....	215
speedometer.....	30
stand, side	154
start button	36
starting,	
engine.....	53
troubleshooting.....	183
steering lock.....	64
stop switch, engine	36

(cont'd)

Index

stopping engine.....	56
storage,	
motorcycle	176
owner's manual	89
suspension,	
front suspension adjustment.....	135
front suspension spring pre-load.....	136
rear suspension adjustment	137
rear suspension spring pre-load.....	138, 139
rear suspension damping	140
switch,	
engine stop.....	36
hazard.....	37
headlight dimmer.....	38
ignition.....	35
turn signal	38

T

tachometer	14, 18
temperature meter,	
air	28
coolant.....	26
theft prevention tips.....	66
throttle.....	120
tires,	
air pressure.....	148
flat.....	188
replacing	151
tool kit	88
training, rider	2, 44
transporting your motorcycle	179
tripmeter.....	31
trouble, unexpected	181
troubleshooting, starting.....	183
turn signal indicators	19, 23

V

vehicle identification no. (VIN)..... 212

W

warranty,

 coverage..... 237

 extended..... 237

 service..... 238

washing your motorcycle 169

weight limit..... 49

wheels,

 front removal..... 191

 rear removal..... 197

The following is a brief, but important collection of information you need to know about your Honda. You'll also find space to record important notes.

How To Avoid Costly Repairs

The engine of your Honda can be the most expensive component to repair. Proper maintenance, especially the use of the recommended fluids and filters, prevents premature wear and damage.

Frequent causes of costly repairs are:

- Engine oil: insufficient quantity, improper oil.
- Air cleaner: dirty, leaking because of improper installation (poor seal).

Record important information on the following page:

Quick Reference

VIN/Frame No.	
Engine No.	
Frame No.	
Ignition Key No.	
Color Label	
Owner's Name	
Address	
City/State	
Phone	
Dealer's Name	
Address	
City/State	
Phone	
Service Mgr.	

Quick Reference

Quick Reference

Scheduled Maintenance	Initial: 600 miles (1,000 km) Regular: every 4,000 miles (6,400 km)
Pre-ride Inspection	Check the following items each time before you ride (page 45): tires & wheels, chain, leaks, loose parts, lights, throttle, brakes, indicators.
Periodic Checks	Check the following items monthly (page 77): tires & wheels, fluids, lights, freeplay, drive chain, fuses, nuts & bolts.
Fuel/Capacity	unleaded gasoline, pump octane number 86 or higher 5.81 US gal (22.0 l)
Engine Oil	API Service Classification SG or higher except oils labeled as energy conserving on the circular API service label, SAE 10W-40, JASO T 903 standard MA, Pro Honda GN4 or HP4 (without molybdenum additives) 4-stroke oil or equivalent
Maximum Weight Capacity	399 lbs (181 kg) 408 lbs (185 kg) Canada rider, passenger, all cargo and accessories

Quick Reference

Tires	Front: 120/70ZR17M/C (58W) BRIDGESTONE BT020F BB or DUNLOP D204FK or METZELER MEZ4A FRONT Rear: 180/55ZR17M/C (73W) BRIDGESTONE BT020R BB or DUNLOP D204K or METZELER MEZ4A Type: radial – ply, tubeless
Tire Pressure (cold)	Front: 36 psi (250 kPa , 2.50 kgf/cm ²) Rear: 42 psi (290 kPa , 2.90 kgf/cm ²)
Spark Plugs	standard: IMR9B – 9H (NGK) or VNH27Z (DENSO) cold climate: IMR8B – 9H (NGK) or VNH24Z (DENSO)
Coolant	ethylene glycol antifreeze (silicate-free) for aluminum engines in 50/50 solution with Pro Honda HP Coolant or an equivalent distilled water
Fuses	main A: 30A main B: 30A other: 10A, 20A, 30A (INTERCEPTOR ABS ONLY)

Quick Reference